

# MANAGEMENT MODEL

## Determine Authorizations

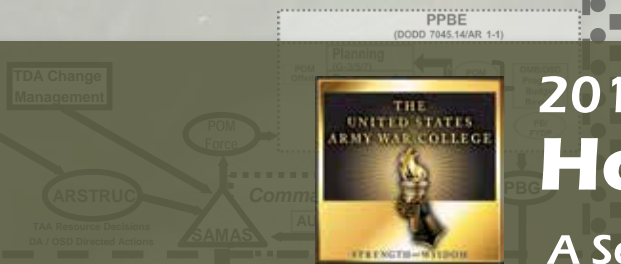

2017-2018

# How the Army Runs

A Senior Leader Reference Handbook

## Operational Models

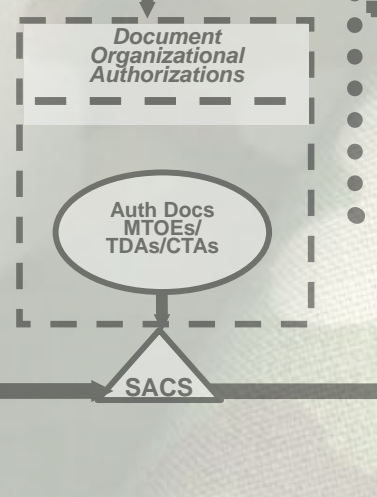
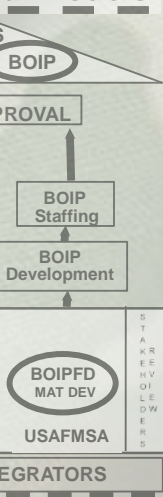

## Acquire, Train, and Distribute Personnel

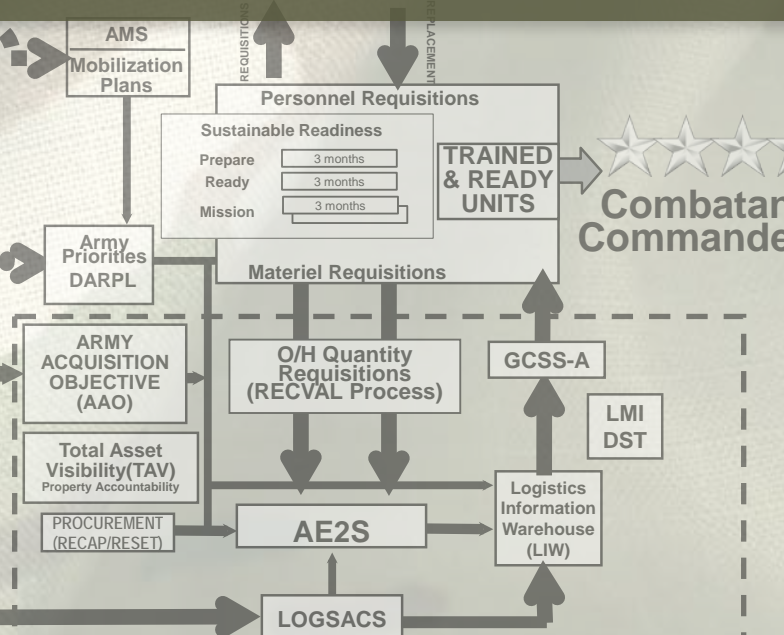
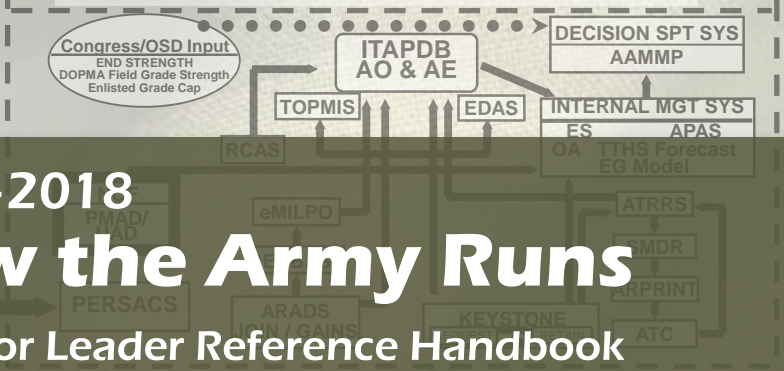

## Acquire/Distribute/Sustain/Dispose Materiel

## Acquire Materiel Solutions

### Defense Acquisition System

- The Materiel Development Decision (MDD) precedes entry into any phase of the Defense Acquisition System
- Entrance criteria met before entering phase

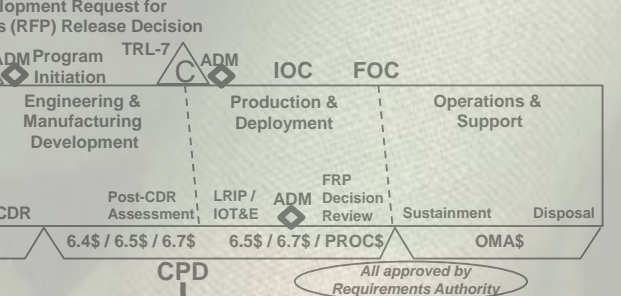

## to Capabilities Process (JCIDS)

### Major Sub-Processes

- Training Developments
- Human Systems Integration (HSI)
- Contracting

### MATERIEL DEVELOPERS

- JOIN: Joint Optical Information System
- JP: Joint Planning
- JROC: Joint Requirements Oversight Council
- JSCP: Joint Strategic Capabilities Plan
- JSPS: Joint Strategic Planning System
- JSR: Joint Strategy Review
- JWE: Joint Warfighting Experiment
- KEYSTONE: Capstone Recruit & Retention System\*
- LFT&E: Live Fire Test and Evaluation
- LIW: Logistics Information Warehouse
- LMI: Lead Materiel Integrator
- LOGSACS: Logistics Structure and Composition System
- LRIP: Low Rate Initial Production
- MAT DEV: Materiel Developer
- MDD: Materiel Development Decision
- MILCON: Military Construction
- MOD: Modernization/Modernize
- MS: Milestone
- MSA: Materiel Solution Analysis
- MTOE: Modified Table of Organization and Equipment
- NDS: National Defense Strategy
- NMS: National Military Strategy
- NOF: Notional Force
- NSS: National Security Strategy
- OA: Officer Aggregate
- OIH: On Hand
- OMA: Operations and Maintenance Appropriations
- OMAS: Operations and Maintenance Appropriation Dollars
- OPLAN: Operation Plan
- ORDAB: Organizational Requirements Document Approval Briefing
- OSD: Office of the Secretary of Defense
- PBG: Program and Budget Guidance
- PERSACS: Personnel Structure and Composition System
- PMIAD: Personnel Management Authorization Document
- POI: Program of Instruction
- POM: Program Objective Memorandum
- POTUS: President of the United States
- PM: Program Manager
- PPBE: Planning, Programming, Budgeting and Execution Process
- PROCS: Procurement Dollars
- PDR: Preliminary Design Review
- RCAS: Reserve Component Automation System
- RDA: Research, Development, and Acquisition
- RDE: Research Development Test and Evaluation
- RECBASS: Reception Battalion Automated Support System
- RMD: Resource Management Decision
- S & T: Science & Technology
- SACS: Structure and Composition System
- SAMAS: Structure and Manpower Allocation System
- SDOB: Secretary of Defense Orders Book
- SMDR: Structure and Manning Decision Review
- SRCA: Service-Retained, Combatant Command-Aligned
- SSO: Synchronization Staff Officer
- SRM: Sustainable Readiness Model
- T & E: Test & Evaluation
- TAA: Total Army Analysis
- TADSS: Training aids, devices, simulations, and simulators
- TAPDB: Total Army Personnel Database
- TAPDB-AE: Total Army Personnel Data Base-Active Enlisted
- TAPDB-AO: Total Army Personnel Data Base-Active Officer
- TAV: Total Asset Visibility
- TD: Technology Demonstration
- TD: Training Development
- TDA: Table of Distribution and Allowances
- TNG DEV: Training Developer
- TOE: Table of Organization and Equipment
- TOPMIS: Total Officer Personnel Management Information System
- TPG: Transformation Planning Guidance
- TRADOC: US Army Training and Doctrine Command
- TRL: Technology Readiness Level
- TTHS: Trainees, Transients, Holdees, Students
- UAD: Updated Authorization Document
- UCP: Unified Command Plan
- URS: Unit Reference Sheet
- USAFMSA: United States Army Force Management Support Agency
- USAR: United States Army Reserve
- U.S.C.: United States Code

**Disclaimer: The systems, processes, and views described in this book reflect the judgments and interpretations of authors and editors, and do not necessarily represent the official policies or positions of the Headquarters, Department of the Army, the Department of Defense, or the United States Government. The text is a synthesis and interpretation of existing and developing National, Defense, Joint, and Army systems, processes, and procedures currently practiced, and is intended only for instructional purposes with the United States Army War College and Army Force Management School, and as an informal desk reference for their graduates and other interested organizations and project officers.**



DEPARTMENT OF THE ARMY  
UNITED STATES ARMY WAR COLLEGE AND CARLISLE BARRACKS  
CARLISLE, PENNSYLVANIA 17013-5210

January 18, 2018

Office of the Commandant

The U.S. Army War College (USAWC), School of Strategic Landpower, is proud to present the 31st edition of *How the Army Runs: A Senior Leader Reference Handbook, 2017–2018*. This text is particularly relevant at a time when the Army is making critical decisions regarding balancing force structure, readiness, and modernization in the midst of budget uncertainty and ambiguity regarding continuing conflicts throughout the world. In order to be successful, the Army must support decision-makers with effective and understandable systems and processes. This book describes the current Army systems and processes that support those critical decisions.

This edition is being released electronically on both fixed media (CD) and on the USAWC website: <https://ssl.armywarcollege.edu/dclm/pubs/HTAR.pdf>. It will also be published in hard copy. The CD version includes the ability to link to our website where changes will be posted between bi-annual updates.

This text was prepared under the direction of the faculty of the USAWC Department of Command, Leadership, and Management. It is intended for use in an academic environment to study the systems and processes for developing and sustaining combat forces to be used by Combatant Commanders. It is also intended as a reference for those who use and “run” the organizations, systems, and processes described.

Every effort has been made to ensure the text accurately describes the systems and processes as they are. While there is no intent to advocate either the reform of the described systems or their continuance, the text does provide a foundation of knowledge for those who are charged with developing potential reforms.

We look forward to your comments regarding the value of the text to you and to your organization.

Sincerely,

A handwritten signature in black ink, appearing to read "J. Kem".

John S. Kem  
Major General, U.S. Army  
Commandant

## PREFACE

This text explains and synthesizes the functioning and relationships of numerous Defense, Joint, and Army organizations, systems, and processes involved in the development and sustainment of trained and ready forces for the Combatant Commanders.

It is designed to be used by the faculty and students at the U.S. Army War College (as well as other training and educational institutions) as they improve their knowledge and understanding of "How the Army Runs." It is also used extensively by participants in the processes described as a reference book. We are proud of the value that senior commanders and staffs place in this text and are pleased to continue to provide it as a reference.

The text is revised every two years as we strive to capture the most up-to-date information available. This involves the synthesis of a wide array of published and unpublished references from a variety of sources. Necessarily, there is a point in time at which updates must stop.

This volume contains our best description of the systems, processes, and organizations as of November 2017; however, we caution the reader that there may be some inaccuracies as systems or processes evolve from the description in the text. We encourage all readers to contribute to its continued development and improvement. Please send your recommendations for changes, improvements, and additions to the Department of Command, Leadership, and Management, U.S. Army War College, Carlisle, Pennsylvania 17013-5240, ATTN: Editor, "How the Army Runs." To the maximum extent possible these changes will be posted to our Internet site pending the next complete update. The text can also be accessed over the Internet at <http://www.carlisle.army.mil/usawc/dclm/htar.cfm>.

We request that the text contained on this web site not be quoted, extracted for publication, or otherwise copied or distributed without prior coordination with the Department of Command, Leadership, and Management of the U.S. Army War College. (You may contact us at commercial telephone number 717-245-4815.)

The U.S. Army War College also extends its appreciation to the staff and faculty of the Army Force Management School and other contributing organizations for their efforts in the publication of this text.

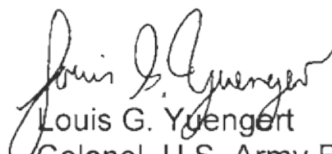
  
Louis G. Yuengert  
Colonel, U.S. Army Retired  
Editor, "How the Army Runs"



## U.S. Army War College Faculty Editors

Chap #	Chapter Title	Editor	Phone #	EEmail@mail.mil
N/A	Executive Summary	Prof. Lou Yuengert <b>(Volume Editor)</b>	(717) 245-4790	louis.g.yuengert.civ
1	Introduction	Prof. Lou Yuengert	(717) 245-4790	louis.g.yuengert.civ
2	Strategy and Strategic Direction	Dr. Rich Meinhart	(717) 245-4797	richard.m.meinhart.civ
3	Force Management	Prof. Ed Filiberti	(717) 245-3715	edward.j.filiberti.civ
4	Army Organization	Prof. Ed Filiberti	(717) 245-3715	edward.j.filiberti.civ
5	Army Mobilization and Deployment	Prof. Doug Waters	(717) 245-3821	douglas.e.waters.civ
6	Reserve Components	COL Barrett Parker	(717) 245-4800	barrett.k.parker.mil
7	Force Readiness	Prof. Lou Yuengert	(717) 245-4790	louis.g.yuengert.civ
8	Army Planning, Programming, Budgeting, and Execution Process	Prof Fred Gellert	(717) 245-4785	frederick.j.gellert.civ
9	Resource Management	Prof. Lou Yuengert	(717) 245-4790	louis.g.yuengert.civ
10	Capability Requirements and Materiel System Research, Development, and Acquisition Management	Prof. Lou Yuengert	(717) 245-4790	louis.g.yuengert.civ
11	Logistics	COL Darrell Aubrey	(717) 245-3195	darrell.w.aubrey.mil
12	Military Human Resource Management	COL John Sena	(717) 245-4805	john.e.sena.mil
13	Civilian Human Resource Management	Ms. Julie Manta	(717) 245-4872	julie.t.manta.civ
14	Training and Leader Development	Prof Lou Yuengert	(717) 245-4790	louis.g.yuengert.civ
15	Information Management and Information Technology	Mr. Paul Tressler	(717) 245-3653	paul.e.tressler.civ
16	Installation Management Community	COL John Sena	(717) 245-4805	john.e.sena.mil
17	Army Health System	Prof. Lou Yuengert	(717) 245-4790	louis.g.yuengert.civ
18	Civil Functions of the Department of the Army	COL Jerome T. Sibayan	(717) 245-3591	jerome.t.sibayan.mil
19	Public Affairs	Prof Lou Yuengert	(717) 245-4790	louis.g.yuengert.civ
20	Defense Support of Civil Authorities	COL Barrett Parker	(717) 245-4800	barrett.k.parker.mil

Note: If you cannot contact a Chapter Editor, please contact the Volume Editor.

## Army Force Management School, HQDA, and Army Agency Authors

Chap #	Chapter Title	Author	Phone #	EEmail@mail.mil
N/A	Executive Summary	COL(Ret) Ben Rivera, AFMS	(703) 805-4905	bienvenido.rivera.ctr
1	Introduction	COL(Ret) Pete Colón, AFMS ( <b>Volume Author</b> )	(703) 805-2122	pedro.j.colon12.ctr
2	Strategy and Strategic Direction	COL(Ret) Jude Fernan, AFMS	(703) 805-1274	jude.c.fernan.ctr
3	Force Management	LTC(Ret) Tony Caldwell, AFMS	(703) 805-3261	marion.a.caldwell.ctr
4	Army Organization	COL(Ret) Pete Colón, AFMS	(703) 805-2122	pedro.j.colon12.ctr
5	Army Mobilization and Deployment	LTC(Ret) Kurt Speed, AFMS	(703) 805-2372	kurt.w.speed.ctr
6	Reserve Components	LTC(Ret) Kurt Speed, AFMS	(703) 805-2372	kurt.w.speed.ctr
7	Force Readiness	LTC(Ret) Larissa Ginty, AFMS	(703) 805-3507	larissa.a.ginty.ctr
8	Army Planning, Programming, Budgeting, and Execution Process	LTC(Ret) Colin Halvorson, AFMS	(703) 805-4486	colin.o.halvorson.ctr
9	Resource Management	LTC(Ret) Colin Halvorson, AFMS	(703) 805-4486	colin.o.halvorson.ctr
10	Capability Requirements and Materiel System Research, Development, and Acquisition Management	MAJ(Ret) Greg Hamlett (PhD), AFMS	(703) 805-2362	gregory.l.hamlett.ctr
11	Logistics	LTC(Ret) Tony Caldwell, AFMS w/LTC Nathan Goubeaux, HQDA G-4	(703) 805-2122	marion.a.caldwell.ctr
12	Military Human Resource Management	LTC(Ret) Larissa Ginty, AFMS	(703) 805-3507	larissa.a.ginty.ctr
13	Civilian Human Resource Management	LTC(Ret) Larissa Ginty, AFMS	(703) 805-3507	larissa.a.ginty.ctr
14	Training and Leader Development	Mr. Charles Scott, DAMO-TR	(703) 614-9816	charles.r.scott18.ctr
15	Information Management and Information Technology	Mr. Keith Dean, HQDA CIO / G-6	(703) 545-1354	keith.t.dean1.civ
16	Installation Management Community	Ms. Cherie Sands, HQDA G-3/7 FM	(703) 693-3139	cheryl.sands.civ
17	Army Health System	COL(Ret) Pete Colón, AFMS	(703) 805-2122	pedro.j.colon12.ctr
18	Civil Functions of the Department of the Army	Mr. Brian Sullivan, USACE	(202) 761-1878	brian.j.sullivan7.civ
19	Public Affairs	Ms. Diane Tyler-Grant, OCPA	(301) 677-7274	diane.a.grant.civ
20	Defense Support of Civil Authorities	COL(Ret) Terry Melton, AFMS	(571) 358-5777	terry.l.melton.ctr

Note: If you cannot contact a Chapter Author, please contact the Volume Author.

Table of Contents

**Executive Summary** .....viii

**Chapter 1—Introduction**

Section I—Fulfilling the Intent of Congress.....1-1

Section II—How The Army Runs—The Text.....1-3

Section III—Summary and References.....1-4

**Chapter 2—Strategy and Strategic Direction**

Section I—Introduction.....2-1

Section II—National-Level Strategy.....2-2

Section III—Defense-Level Strategy.....2-3

Section IV—Global Force Management.....2-5

Section V—Joint-Level Strategy.....2-7

Section VI—Joint Planning.....2-16

Section VII—Army-Level Strategy.....2-20

Section VIII—Summary, Key Terms, and References.....2-23

*Figures*

Figure 2-1. Joint Strategic Planning System.....2-9

Figure 2-2. Unified Combatant Commands.....2-15

Figure 2-3. Unified Action in Execution.....2-17

Figure 2-4. Joint Planning and Execution Community.....2-18

Figure 2-5. Joint Operation Planning.....2-19

**Chapter 3—Force Management**

Section I—Introduction.....3-1

Section II—Force Development.....3-8

Section III—Force Development Phase I—Develop Capability Requirements.....3-9

Section IV—Force Development Phase II—Design Organizations.....3-18

Section V—Force Development Phase III—Develop Organizational Models.....3-20

Section VI—Force Development Phase IV—Determine Organizational Authorizations.....3-23

Section VII—Force Development Phase V—Document Organizational Authorizations.....3-29

Section VIII—Force Integration.....3-30

Section IX—Force Generation.....3-30

Section X—Change Management.....3-33

Section XI—Summary, Key Terms, and References.....3-38

*Figures*

Figure 3-1. Army Force Management Model.....Back of Book Fold-Out

Figure 3-2. Structure and Composition System.....3-4

Figure 3-3. Army Organizational Life Cycle Model.....3-6

Figure 3-4. Force Development Process.....3-8

Figure 3-5. Army Concept Framework.....3-11

Figure 3-6. Capabilities-Based Assessment Process.....3-14

Figure 3-7. Solutions Documents.....3-17

Figure 3-8. Force Design Update.....3-19

Figure 3-9. Modernization Over Time (Resource-Driven).....3-22

Figure 3-10. Total Army Analysis “End-to-End” Process.....3-24

Figure 3-11. TDA Change Management Thresholds.....3-33

Figure 3-12. Sustainable Readiness Steps.....3-35

Figure 3-13. Sustainable Readiness Modules.....3-37

# HOW THE ARMY RUNS

## Chapter 4—Army Organization

Section I—Introduction.....	4-1
Section II—The Production Subsystem.....	4-2
Section III—The Combat Subsystem.....	4-8
Section IV—The Integrating Subsystem.....	4-9
Section V—Summary and References.....	4-11

### Figure

Figure 4-1. Headquarters, Department of the Army Organization.....	4-10
--	------

## Chapter 5—Army Mobilization and Deployment

Section I—Introduction.....	5-1
Section II—Army Mobilization.....	5-1
Section III—Industrial Preparedness.....	5-8
Section IV—Summary and References.....	5-11

### Figures

Figure 5-1. Army Mobilization System Subsystems.....	5-2
Figure 5-2. Reserve Component Utilization Authorities.....	5-6
Figure 5-3. Mobilization and Execution Process.....	5-7
Figure 5-3. Reserve Categories and Mobilization.....	5-8

## Chapter 6—Reserve Components

Section I—Introduction.....	6-1
Section II—Reserve Service.....	6-2
Section III—Reserve Components Management.....	6-4
Section IV—Training.....	6-7
Section V—Equipment.....	6-9
Section VI—Readiness and Mobilization Assistance.....	6-9
Section VII—Summary and References.....	6-11

### Figures

Figure 6-1. Reserve Service Categories.....	6-2
Figure 6-2. State Partnership Program.....	6-8
Figure 6-3. Reserve Component Access.....	6-8

## Chapter 7—Force Readiness

Section I—Introduction.....	7-1
Section II—Unit Readiness Reporting.....	7-2
Section III—Strategic Readiness.....	7-6
Section IV—Department of Defense Readiness Reporting System.....	7-10
Section V—Summary, Key Terms, and References.....	7-11

### Figures & Tables

Figure 7-1. Readiness Framework.....	7-2
Figure 7-2. Unit Readiness Fundamentals.....	7-3
Figure 7-3. Army Strategic Readiness Process.....	7-6
Figure 7-4. Chairman’s Readiness System.....	7-9

## Chapter 8—Army Planning, Programming, Budgeting, and Execution Process

Section I—Introduction.....	8-1
Section II—Department of Defense Planning, Programming, Budgeting, and Execution Process.....	8-1
Section III—The Army Planning, Programming, Budgeting, and Execution Process.....	8-9
Section IV—Leading Army Planning, Programming, Budgeting, and Execution System Phases.....	8-11
Section V—Supporting Responsibilities in the Army for Planning, Programming, Budgeting, and Execution System.....	8-15
Section VI—Allocation of Resources.....	8-27
Section VII—Army Planning, Programming, Budgeting, and Execution Deliberative Forums.....	8-31
Section VIII—Army Planning, Programming, Budgeting, and Execution—Planning.....	8-35



## TABLE OF CONTENTS

Section IX—Integrated Programming—Budgeting Phase.....	8-35
Section X—Army Budget Execution Phase.....	8-42
Section XI—Program Performance and Review.....	8-45
Section XII—Summary, Key Terms, and References.....	8-46

### *Figures*

Figure 8-1. Department of Defense Planning, Programming, Budgeting, and Execution Phases.....	8-2
Figure 8-2. Summary of Planning, Programming, Budgeting, and Execution Phases.....	8-3
Figure 8-3. Major Force Programs.....	8-4
Figure 8-4. Future Years Defense Program.....	8-6
Figure 8-5. Department of Defense Review / Decision-Making Bodies.....	8-8
Figure 8-6. Management Decision Execution Package.....	8-28
Figure 8-7. Fiscal Year 17-21 Program Objective Memorandum Management Decision Execution Package.....	8-29
Figure 8-8. Planning, Programming, Budgeting, and Execution Decision Committees and Processes.....	8-32
Figure 8-9. Program Evaluation Groups.....	8-33
Figure 8-10. Program Evaluation Group Functions.....	8-34
Figure 8-11. Army Resource Framework Hierarchy.....	8-37
Figure 8-12. Program Objective Memorandum / Budget Estimate Submission Timeline.....	8-38
Figure 8-13. Planning, Programming, Budgeting, and Execution Timeline.....	8-39
Figure 8-14. Program and Budget Timeline.....	8-40

### *Tables*

Table 8-1. Future Years Defense Programs and Subprograms with Army Proponents.....	8-5
Table 8-2. Managers for Manpower and Force Structure Issues.....	8-11
Table 8-3. Budget Activity Management Structure for Operation and Maintenance Appropriations.....	8-17
Table 8-4. Budget Activity Management Structure for Operation and Maintenance Appropriations-Army Manpower-Only Activity Structure.....	8-20
Table 8-5. Budget Activity Management Structure for Operation and Maintenance Appropriation-Base Operations Support.....	8-20
Table 8-6. Budget Activity Management Structure for Operation and Maintenance Appropriations-Sustainment, Restoration, and Modernization.....	8-22
Table 8-7. Budget Activity Management Structure for Operation and Maintenance Appropriations-Army National Guard.....	8-23
Table 8-8. Budget Activity Management Structure for Operations and Maintenance Appropriations-United States Army Reserve.....	8-24
Table 8-9. Army Appropriations-Managers for Functional Requirements and Program and Performance.....	8-25

## **Chapter 9—Resource Management**

Section I—Introduction.....	9-1
Section II—Acquire Resources.....	9-4
Section III—Allocate Resources to the Field.....	9-5
Section IV—Account for the Use of Resources.....	9-7
Section V—Analyze the Use of Resources.....	9-11
Section VI—Improving Management and Business Practices in the Army.....	9-12
Section VII—Non-Appropriated Funds.....	9-22
Section VIII—Summary, Key Terms, and References.....	9-24

### *Figures*

Figure 9-1. Office of the Assistant Secretary of the Army (Financial Management and Comptroller).....	9-3
Figure 9-2. Fund Distribution Process.....	9-6
Figure 9-3. Cycle of Commitment and Review.....	9-19
Figure 9-4. Cost-Benefit Analysis.....	9-22

### *Tables*

Table 9-1. Translating an Accounting Code.....	9-11
Table 9-2. Funds Management Business Process Change Summary.....	9-21

# HOW THE ARMY RUNS

## Chapter 10—Capability Requirements and Materiel System Research, Development, and Acquisition Management

Section I—Introduction.....	10-1
Section II—Capabilities Integration and Development.....	10-2
Section III—Capabilities Requirements Documents.....	10-4
Section IV—Requirements Review and Validation Process.....	10-10
Section V—Urgent and Emergent Operational Need Validation.....	10-19
Section VI—Materiel Systems Acquisition.....	10-23
Section VII—Materiel Systems Science and Technology.....	10-23
Section VIII—Department of Defense Acquisition Organization and Management.....	10-29
Section IX—Army Acquisition Materiel Development, Oversight, and Management.....	10-30
Section X—Operation of the Defense Acquisition System.....	10-40
Section XI—Acquisition Oversight and Review.....	10-52
Section XII—Acquisition Documentation.....	10-54
Section XIII—Testing and Evaluation.....	10-57
Section XIV—Integrated Product Support.....	10-58
Section XV—Army Human System Integration.....	10-60
Section XVI—Training Development.....	10-61
Section XVII—Joint Warfighting Assessment and Network Integration Evaluation Processes.....	10-64
Section XVIII—Acquisition Resource Management.....	10-66
Section XIX—Summary, Key Terms, and References.....	10-68
<i>Figures</i>	
Figure 10-1. Three “Requirements Lanes”.....	10-3
Figure 10-2. Capabilities Needs Analysis (CNA) Overview.....	10-4
Figure 10-3. Information Technology Box Components for Information Systems-Initial Capabilities Document.....	10-6
Figure 10-4. Information Technology Box Components for Information Systems-Capability Development Document.....	10-7
Figure 10-5. Linking JCIDS to the DAS.....	10-10
Figure 10-6. JCIDS Document Staffing Tracks.....	10-11
Figure 10-7. Joint Requirements Oversight Council.....	10-12
Figure 10-8. Joint Capabilities Board.....	10-13
Figure 10-9. Functional Capabilities Board.....	10-14
Figure 10-10. Joint Capabilities Integration and Development System – Validation / Approval Process.....	10-16
Figure 10-11. Army Requirements Oversight Council Structure.....	10-17
Figure 10-12. Rapid Response Framework.....	10-18
Figure 10-13. Army Requirements and Resourcing Board Organization.....	10-13
Figure 10-14. Acquisition Categories.....	10-24
Figure 10-15. Acquisition Categories.....	10-25
Figure 10-16. Technology Readiness Levels.....	10-27
Figure 10-17. Army Acquisition Executive.....	10-31
Figure 10-18. Department of Defense Acquisition Authority Chain.....	10-33
Figure 10-19. Defense Acquisition System, Model 1: Hardware Intensive Program.....	10-41
Figure 10-20. Model 2: Defense Unique Software Intensive Program.....	10-42
Figure 10-21. Model 3: Incrementally Deployed Software Intensive Program.....	10-43
Figure 10-22. Model 4: Accelerated Acquisition Program.....	10-44
Figure 10-23. Model 5: Hybrid Program A (Hardware Dominant).....	10-45
Figure 10-24. Model 6: Hybrid Program B (Software Dominant).....	10-46
Figure 10-25. Types/Categories of Contracts.....	10-64
Figure 10-26. Joint Warfighting Assessment Concept.....	10-65
Figure 10-27. NIE/JWA Construct.....	10-66

**Chapter 11—Logistics**

Section I—Introduction.....11-1  
 Section II—National Logistics Organization—Assistant Secretary of the Army (Acquisition, Logistics, and Technology), Army G-4, Army G-8, Army Materiel Command, and Logistics Innovation Agency...11-6  
 Section III—National Logistics Organizations—Other.....11-15  
 Section IV—Summary, Key Terms, and References.....11-19  
*Figure*  
 Figure 11-1. Foreign Military Sales Process.....11-10

**Chapter 12—Military Human Resource Management**

Section I—Introduction.....12-1  
 Section II—The Structure Function.....12-4  
 Section III—The Acquisition Function.....12-7  
 Section IV—The Compensation Function.....12-10  
 Section V—The Distribution Function.....12-11  
 Section VI—The Development Function.....12-18  
 Section VII—The Sustainment Function.....12-30  
 Section VIII—The Transition Function.....12-31  
 Section IX—Summary, Key Terms, and References.....12-34

*Figures*

Figure 12-1. Manpower Strength Relationships.....12-5  
 Figure 12-2. Enlisted Procurement.....12-7  
 Figure 12-3. Manning Programs.....12-11  
 Figure 12-4. Enlisted Automation Management System.....12-13  
 Figure 12-5. Officer Distribution.....12-17  
 Figure 12-6. Warrant Officer Training and Education.....12-22  
 Figure 12-7. Warrant Officer Promotion Timeline.....12-23  
 Figure 12-8. Functionally Aligned Officer Personnel Management System Design.....12-25  
 Figure 12-9. Centralized Selection List Categories.....12-27  
 Figure 12-10. IPPS-A Incremental Areas by Release.....12-34

*Tables*

Table 12-1. Warrant Officer Promotion Goals.....12-22  
 Table 12-2. Career Progression Pattern.....12-28

**Chapter 13—Civilian Human Resource Management**

Section I—Introduction.....13-1  
 Section II—Organization of Civilian Personnel Management.....13-2  
 Section III—Civilian Human Resource Service Delivery.....13-7  
 Section IV—Personnel Management at Installation / Activity Level.....13-8  
 Section V—Equal Employment Opportunity in the Army.....13-15  
 Section VI—Executive and Senior Professional Personnel.....13-18  
 Section VII—Defense Civilian Intelligence Personnel System.....13-19  
 Section VIII—Army Personnel Transformation.....13-20  
 Section IX—Summary and References.....13-21

*Figures*

Figure 13-1. Differences Between the Military and Civilian Systems .....13-3  
 Figure 13-2. Civilian Expeditionary Workforce Model.....13-21

**Chapter 14—Training and Leader Development**

Section I—Introduction.....14-1  
 Section II—Strategic Training Framework.....14-1  
 Section III—Operational Training.....14-3  
 Section IV—Institutional Training.....14-9

# HOW THE ARMY RUNS

Section V—Military Functional Area and Skill Training.....	14-18
Section VI—Future of Army Training.....	14-19
Section VII—Training Governance.....	14-20
Section VIII—Leader Development.....	14-22
Section IX—Civilian Training and Leader Development.....	14-26
Section X—Training Support.....	14-30
Section XI—Policy, Requirements, and Resourcing Process.....	14-33
Section XII—Summary and References.....	14-33
<i>Figures</i>	
Figure 14-1. Army Training Ends, Ways, and Means .....	14-2
Figure 14-2. Combat Training Center Governance.....	14-8
Figure 14-3. Reserve Component The Army School System Functional Alignment.....	14-11
Figure 14-4. Structure and Manning Decision Review Overview.....	14-16
Figure 14-5. The Army University.....	14-17
Figure 14-6. Training General Office Steering Committee Governance .....	14-21
Figure 14-7. Army Leader Development Model.....	14-23
Figure 14-8. Basic Active Component Non-Commissioned Officer Career Development Timeline.....	14-24
Figure 14-9. Warrant Officer Development Timeline.....	14-25
Figure 14-10. Officer Development Timeline.....	14-25
Figure 14-11. Training Input to the Planning, Programming, Budgeting, and Execution Process.....	14-35
<b>Chapter 15—Information Management and Information Technology</b>	
Section I—Introduction.....	15-1
Section II—Army Network Strategy.....	15-3
Section III—Army Enterprise Management.....	15-4
Section IV—Army Chief Information Officer / G-6 Strategic Partnerships.....	15-8
Section V—Summary, Key Terms, and References.....	15-10
<b>Chapter 16—Installation Management Community</b>	
Section I—Introduction.....	16-1
Section II—Roles and Missions.....	16-3
Section III—Initiatives and Programs.....	16-13
Section IV—Summary and References.....	16-15
<i>Figures</i>	
Figure 16-1. Installation Management Community Hierarchy.....	16-3
Figure 16-2. Installation Management Command.....	16-8
<b>Chapter 17—Army Health System</b>	
Section I—Introduction.....	17-1
Section II—Army Medical Department Mission and Support to Commanders.....	17-3
Section III—The Army Health System.....	17-5
Section IV—Command and Management.....	17-7
Section V—Summary and References.....	17-12
<i>Figures</i>	
Figure 17-1. Army Medical Command.....	17-7
Figure 17-2. United States Medical Command Current Structure.....	17-8
<b>Chapter 18—Civil Functions of the Department of the Army</b>	
Section I—Introduction.....	18-1
Section II—Civil Works Program.....	18-4
Section III—Support to Other Government Agencies.....	18-11
Section IV—Engineer Overseas Activities.....	18-13
Section V—Support to Unified Combatant Commanders.....	18-15
Section VI—Summary and References.....	18-16
<i>Figure</i>	



Figure 18-1. Where We Are: U.S. Army Corps of Engineers .....18-11

**Chapter 19—Public Affairs**

Section I—Introduction.....19-1

Section II—Army Public Affairs Organizations.....19-5

Section III—Summary, Key Terms, and References.....19-8

*Figure*

Figure 19-1. Department of Defense Principles of Information.....19-3

**Chapter 20—Defense Support of Civil Authorities**

Section I—Introduction.....20-1

Section II—Domestic Emergency Management Environment.....20-4

Section III—Federal Role in the National Response Process.....20-8

Section IV—Defense Support Process.....20-13

Section V—Defense Support of Civil Authorities Mission Category—Disasters and Declared  
Emergencies.....20-15

Section VI—Defense Support of Civil Authorities Mission Category—Restore Public Health and  
Services and Civil Order.....20-19

Section VII—Defense Support of Civil Authorities Mission Category—Special Events and  
Planned Periodic Support.....20-20

Section VIII—Summary and References.....20-20

*Figures*

Figure 20-1. National Response Plan (Stafford Act).....20-5

Figure 20-2. National Response Plan (Non-Stafford Act).....20-6

Figure 20-3. CBRN Response Enterprise.....20-17

*Table*

Table 20-1. Federal Response Plan Emergency Support Functions.....20-11

**Terms**.....T-1

**Glossary**.....G-1

## Executive Summary

At the time of printing this edition, Army senior leaders have directed a task force under the leadership of the Director, Office of Business Transformation, Lieutenant General Edward C. Cardon to organize the Army Futures Command (AFC) with an initial operational capability of 1 July 2018. The Army's current modernization enterprise is challenged to generate requisite capabilities that ensure overmatch against our adversaries. Past ways of thinking, organizing, and executing have limited the Army's ability to pace technological development against adversaries like Russia and China. The Army has established eight cross-functional teams each led by a one-or-two-star general or senior executive service equivalent officer with combat experience to determine high-priority areas where the Army wants to make big capability leaps. This is an inward look to reduce bureaucracy and create a fundamental shift in Army culture and practices. The implications of the AFC on Force Management will be significant and far reaching.

Today, Army Force Management enables Army leaders to generate trained and ready forces for Combatant Commanders (CCDRs). This reference manual provides Army leaders with the details of how people, processes and products come together to balance ends, ways and means to achieve Army objectives.

This Reference Book serves as a primer and ready reference to officers preparing to assume command, leadership and management positions at the strategic level. The volatile, uncertain complex and ambiguous (VUCA) operational environment drives the Army to re-examine how it determines and approves requirements, re-cast how it archives modernization rapidly and at reduced costs while implementing Sustainable Readiness (SR). Through careful study and consideration of the chapters in this text, leaders will:

- Explain the relationships of the force management systems and processes that build current CCDR readiness while planning for future readiness.
- Dissect strategy—at the National, Defense, Joint, and Army levels to understand how it impacts the Army.
- Recognize how Force Development translates requirements across DOTMLPF-P domains into programs and structure.
- Examine how the Army uses three distinct subsystems: production; combat, and integration to produce versatile capabilities for global demands.
- Distinguish Army components (active and reserve) which are uniquely optimized to sustain and expand capabilities to execute the range of military missions (ROMO)
- Identify how the Army measures force readiness.
- Explore the sequential phases of Planning, Programming, Budgeting, Execution (PPBE) process, to align strategy with timelines that support Executive and Legislative approval cycles for resources.
- Examine how the Army participates in the Joint Capabilities Integration and Development System (JCIDS) for developing capabilities.
- Identify recent changes in the Defense Acquisition System (DAS), for building enduring materiel solutions for the military.
- Understand the Army's provision of logistics, personnel services, and health service support necessary to enable mission accomplishment globally.
- Know about the four components of readiness: manning, training, modern equipment and leader development to win decisively.

- Examine how the Army's information management and information technology support the broader and emergent cyber capability.
- Identify where Army readiness occurs: at 154 permanent Army installations and over 1,100 community-based Army National Guard and Army Reserve Centers worldwide.
- Know the U.S. Army Corps of Engineers (USACE) Civil Works program which is focused on the development, protection, and restoration of the Nation's water and related land resources
- Examine the Army's obligation to keep the American people informed, to foster confidence in the Army and its readiness to conduct Unified Land Operations (ULO) globally.
- Examine the laws, Presidential Directives, Executive Orders and Defense Department policy for Defense Support to Civil Authorities (DSCA).

Ultimately, the thoughtful and careful calibration of ends, ways, and means is at the heart of Force Management, and the outcome of how the Army runs—the constant provision of trained, ready, and modern forces for CCDRs when and where they need them.

**This page is intentionally left blank**



## Chapter 1

### Introduction

#### Section I

#### Fulfilling the Intent of Congress

##### 1-1. Changing How We Manage Change

a. On 14 June 1775, our nation's leaders established the Continental Army. Under the Constitution enacted in 1789, this Army became a military department of the federal government and began its long transformation into the modern professional entity it is today. Exemplified by loyalty, respect, and integrity, the Total Army is respected as the backbone of the joint force, the cornerstone of America's national defense, and the anchor of global security. The 187 campaign streamers that adorn the Army's colors serve as a reminder of the moral commitment and personal courage of the troops who stormed the beaches of Normandy, held fast on and off the shores of Okinawa, and fought through the rice paddies of Korea, jungles of Vietnam, sands of Iraq, and the mountains of Afghanistan. Given major changes in the nation's security environment – including geopolitical changes, changes in modern warfare, and changes in the fiscal environment – the updated defense strategy requires that the Army rebalance for a broad spectrum of conflict, sustain its presence and posture abroad to better protect U.S. national security interests, and retain its capability, capacity, and readiness. Ultimately, the Army must fulfill its Title 10, United States Code (USC) responsibilities to organize, train and equip a force that can implement the national security strategy.

b. Fulfilling the intent of Congress, as well as the vision of national-, defense-, joint-, and Army-level leadership, is a formidable task. The Army is a dynamic organization that must constantly change to adapt to emerging threats and their associated new mission sets. Army professionals—especially leaders and force managers—must be capable of driving change to ensure the Army is prepared to prevent conflict, shape the security environment, and win wars, if necessary. Change requires the continual adaptation and development of both materiel and non-materiel solutions across the Army's doctrine, organization, training, materiel, leadership and education, personnel, facilities, and policy (DOTMLPF-P) domains. The Army strives to implement orderly management of change through existing processes in order to minimize turbulence in organizations.

c. Changing large organizations with well-developed cultures embedded in established bureaucracies can be incredibly difficult. People in organizations like the Army with functioning, complex systems and embedded processes tend to resist change or cause change to become more evolutionary. The Army has the internal challenge of ensuring that its processes are both flexible and adaptable to facilitate and not impede change, while also inspiring creativity and rapidly incorporating technological, cognitive, and organizational innovations. This text provides a basis of understanding that empowers continued change in Army resourcing processes. From here, leaders must make informed decisions about force management processes and how they can be used or changed to better provide trained and ready units to combatant commanders (CCDR).

d. One of the most critical responsibilities of Army Senior Leaders and Commanders today is managing change amid fiscal austerity and constrained resources. In a constrained resource environment, Army leaders must make difficult decisions in order to translate national-, defense-, and joint-level guidance into balanced, capable, and ready Operating and Generating Force structures. This responsibility includes allocating diminished resources to a broad range of prioritized mission areas—training, modernization, infrastructure, operations, and maintenance—in order to achieve objectives.

e. Army leaders must be able to weigh priorities to achieve strategic and operational objectives by balancing end strength, capabilities, readiness, and modernization. The need for tough decisions and trade-offs is imperative today as Army leaders face sequestration-level funding reductions with second- and third-order effects on manning, equipping, structuring, and reorganizing.

f. Despite these Army-wide reductions, Army leaders must maintain the highest degree of readiness to respond to national defense challenges and military operations worldwide. Since the Army cannot predict how long the strategic resourcing environment will be driven by the uncertainty of the national military budget or complex threats to national security, it is more important now than ever to mitigate the impacts of these factors.

## 1-2. Managing The Army

a. Force management is the capstone process to establish and field mission-ready Army organizations. The process involves organization, integration, decision making, and execution of the spectrum of activities encompassing requirements definition, force development, force integration, force structuring, capability development, materiel development, training development, resourcing, and all elements of the Army Organizational Life Cycle Model (AOLCM). The focal point of force management is meeting the Secretary of the Army's statutory requirements to recruit, organize, supply, equip, train, service, mobilize, demobilize, administer, maintain and station the Army.

b. The Army Force Management Model, Figure 3-1 (fold-out), is a system of systems approach to providing trained and ready units to CCDRs. The model serves as a roadmap divided into seven distinct modules, each showing its relationship to the others, as well as to the major Department of Defense (DOD) management processes. The modules include—

- (1) Determine strategic and operational requirements.
- (2) Develop required capabilities / DOTMLPF-P solutions.
- (3) Determine authorizations.
- (4) Determine structure (specifically, design organizations, develop organizational models, and document organizational authorizations).
- (5) Acquire materiel solutions.
- (6) Acquire, train, and distribute personnel.
- (7) Acquire and distribute materiel.

c. Although the Force Management Model depicts the flow of processes in a somewhat linear, sequential manner, the complexities of managing change mandate that at any time an initiative may be in several of these processes simultaneously, in parallel, compressed in time, or in reverse order. Eventually, all of the processes and systems within the model must be employed to produce a fully trained, equipped and resourced operational force.

## 1-3. The Army Posture

a. Each year, the SECARMY and CSA testify before Congress on the posture of the United States Army. Designed to reinforce this testimony and additional budget testimonies to the committees and subcommittees of the United States Senate and House of Representatives, the Army Posture Statement (APS) serves a broad audience as a basic reference on the state of the Army. To capture the posture of the Total Army, the Army National Guard (ARNG) and United States Army Reserve (USAR) also publish annual posture statements. The APS is the primary vehicle to tell the Army story. As such, the APS should be read and understood by all Soldiers, civilians, and contractors to appreciate both current challenges and future direction that the systems and processes described in this text must address.

b. Today's Army operates in increasingly complex environment. Uncertainty in the security environment is simultaneously growing across Europe, the Middle East, Africa, and the Pacific and with continued threats to the homeland. Force planning must account for an ill-defined and fluid demarcation between war and peace as influenced by heightened competition for resources, shifting alliances between state and non-state actors that agitate populations, proliferation of weapons of mass destruction (WMD), and cross-domain threats. State and non-state actors mask their aggression through the use of unconventional non-kinetic hostile actions and empowerment of irregular forces that destabilize regions, influence democratic political processes and governments to their advantage. They have used financial and cyber networks in hostile ways, exploited public sympathy, and operated beneath a threshold of violence that would trigger an international response.

c. With continued global instability the U.S. increased its military footprint in the Middle East; advises, trains, equips and enables allies to defeat the Islamic State in Iraq and the Levant; continues to monitor Russian, Chinese, North Korean, and Iranian aggression and ambitions; and continues the fight against Al-Qaeda in Iraq and the Taliban in Afghanistan. At the same time, U.S. Allies look to the U.S. to lead the defense of their global interests. Further, future adversaries have learned from recent military

operations to be more innovative, adaptive, and advanced in their operational approaches. This requires adaptive and innovative responses.

#### **1-4. The Army in Transition**

a. The past two decades have seen the Army transition in many ways. SECARMY White and CSA Shinseki provided an intellectual framework for transformation. SECARMY Harvey and CSA Schoomaker led the Operating Force transformation. SECARMY Geren and CSA Casey articulated the need to adapt institutions and restore balance. Acting SECARMY McCarthy and CSA Milley continue to lead the Army through Force 2025 & Beyond, including employing Regionally Aligned Forces (RAF), implementing sustainable readiness for Army force generation, and overhauling The Army Plan (TAP), to name only a few of the Army's current strategic efforts.

b. The Army's current transition is centered on the trade-offs between capacity (size), readiness, and capability (technological advancement), and the Army has chosen readiness as its top priority. This choice resulted in many Army programs being cancelled, delayed or restructured in the past five years, while the number of defense planning scenarios that included Army forces increased. The National Defense Authorization Act for fiscal year 2018 has not been finalized but is expected to increase the Total Army's end-strength to 1,035,000, an increase of 17,000 across the force.

c. For the foreseeable future, the Army can expect to operate with fewer resources than senior DOD and Army leaders have requested. Nevertheless, the Army, while in transition, will provide tailorable and scalable combinations of special operations and conventional forces, regionally aligned and globally responsive combined arms teams, and foundational theater capabilities to enable joint operations. To do this, both for the operational and the institutional Army, innovation will be critical.

## **Section II**

### **How The Army Runs—The Text**

#### **1-5. Purpose**

a. The purpose of the HTAR is fourfold. First, it describes how the United States Army runs, from strategy to structure to resources, in order to provide trained and ready units to CCDRs. Second, it addresses the systems and processes by which the Army runs in the context of national-, defense-, and joint-level strategy, structure, and resources. Third, it serves as a handbook for officers preparing to assume command, leadership, and force management positions at the senior and strategic levels of leadership. Finally, it explains the relationships of the force management systems and processes that both fill current CCDR requirements and predict, plan, and budget for requirements of the future.

b. While a key use of the HTAR is to support the U.S. Army War College (USAWC) resident and distance education curriculum, the text serves broader purposes to include: use by multi-component Army, sister service, and multi-national students attending force management courses at the Army Force Management School (AFMS) at Fort Belvoir, Virginia; use as a general reference for branch and service schools' professional military education (PME); and use as a primer for HQDA and the force management community of interest who seek to better understand the Army's organization and functions, along with its systems and processes.

#### **1-6. Scope**

HTAR supports the USAWC curriculum, which promotes a better appreciation of the theory and practice of command, leadership, and management in the JIIM environment. Elihu Root founded the USAWC "not to promote war, but to preserve peace by intelligent and adequate preparation to repel aggression." He charged the faculty with directing "the instruction and intellectual exercise of the Army, to acquire information, devise the plans, and study the subjects indicated, and to advise the Commander-in-Chief of all questions of plans, armament, transportation, and military preparation and movement." That focus is addressed in the current USAWC mission statement: "The United States Army War College educates and develops leaders for service at the strategic level while advancing knowledge in the global application of landpower."

## 1-7. Organization

The chapters of the HTAR are organized to describe in detail the seven modules of the force management model as well as the nine force integration functional areas (FIFA) that must be considered within and across these modules. The nine FIFAs, as further described in the text, include structuring, manning, equipping, training, sustaining, deploying, stationing, funding, and readiness.

## 1-8. Authorship

The production of this 2017-2018 volume of the HTAR would not have been possible without the loyal, detailed, and extensive work of military, civilian, and contractor subject matter experts at USAWC, AFMS, HQDA, and Army Publishing Directorate. Thank you all for your significant contributions to this improved handbook.

## Section III

### Summary and References

#### 1-9. Summary

a. Force management is a critical operating function for the Army. It encompasses the many processes that generate future requirements and ensure the Army is efficiently and effectively organized, manned, equipped, trained, and sustained. Force Management provides trained and ready forces to CCMDs now and in the future.

b. Force management is the behind the scenes and preliminary work that leads to tactical success whether commanding U.S. Army forces, international forces, or Joint forces. It is also the important and difficult work that occurs following after action reviews. In an uncertain and unpredictable global security environment, it is never ending.

c. Success in force management is measured on the battlefield in the overmatch of U.S. adversaries and in the boardroom building programs of record to meet commanders' requirements.

d. HTAR is about the systems and processes that Army leaders and force managers must understand, embrace, and employ to ensure the Army remains as effective in service to the Nation in the future as it has been in the past. This text helps its readers understand how the Army runs, as influenced by the President, Congress, DOD, the Joint Chiefs of Staff (JCS), and the members of the Headquarters, Department of the Army (HQDA) Secretariat and Army Staff, as well as Army Commands (ACOM), Army Service Component Commands (ASCC), and Direct Reporting Units (DRU). Students and practitioners of the military art who use HTAR will more fully appreciate the truth in the words of General Harold K. Johnson, CSA from 1964-1968: " The Army is like a funnel. At the top you pour in doctrine, resources concepts, equipment, and facilities. And out at the bottom comes one lone Soldier walking point."

#### 1-10. References

- a. Secretary of the Army Top Priorities, 30 Oct 2014.
- b. 2017 Army Posture Statement, 24 Feb 2017.
- c. National Defense Authorization Act, 2017, 23 Dec 2016.
- d. Title 10, USC @ <http://uscode.house.gov>.
- e. U.S. Army War College @ <http://www.carlisle.army.mil>.

## Chapter 2

### Strategy and Strategic Direction

#### Section I Introduction

##### 2-1. Chapter Content

a. Strategic direction is the common thread that integrates and synchronizes the planning activities and operations of the Joint Staff (JS), combatant commands (CCMD), Services, combat support agencies (CSA), and other Department of Defense (DOD) agencies. Strategy provides purpose and focus to the planning for employment of military force. As an overarching term, strategic direction encompasses the manner, processes, and products by which the President of the United States (POTUS), Secretary of Defense (SECDEF), and Chairman of the Joint Chiefs of Staff (CJCS) provide strategic guidance to the joint force regarding long-term and intermediate objectives.

b. The purpose of the strategy module of the force management model—the first block in the top left corner—is to determine strategic and operational requirements which will then drive change through structure and resources to provide trained and ready units to combatant commanders (CCDR). This chapter will trace national-, defense-, joint-, and Army-level strategy, to include laws, leaders, processes, and documents, as well as establish the connections between each of these echelons of strategy as they influence how the Army runs.

##### 2-2. Strategy-Related Laws

The United States Code (USC) is a consolidation and codification by subject matter of the general and permanent laws of the United States. The Office of the Law Revision Counsel of the United States House of Representatives prepares the USC. The currency date for each section of the USC is displayed above the text of each section. If a section has been affected by any laws enacted after that date, those laws will appear in a list of "Pending Updates." If there are no pending updates listed, the section is current as shown. The USC sections related to strategy include—

a. *Title 10—Armed Forces*. Title 10—Armed Forces, includes—

- (1) Subtitle A—General Military Law.
- (2) Subtitle B—Army.
- (3) Subtitle C—Navy and Marine Corps.
- (4) Subtitle D—Air Force.
- (5) Subtitle E—Reserve Components.

b. *Title 32—National Guard*. Title 32—National Guard, includes Chapter 1—Organization, Chapter 3—Personnel, Chapter 5—Training, Chapter 7—Service, Supply, and Procurement, and Chapter 9—Homeland Defense Activities.

c. *Title 50—War and National Defense*. Title 50—War and National Defense, includes Chapter 44—National Security, Subchapter 1—Coordination for National Security, Section §3021. National Security Council and Section §3043. Annual National Security Strategy Report.

##### 2-3. National Defense Authorization Act

The publication of a National Defense Authorization Act (NDAA) is a key mechanism to provide necessary authorities and funding for America's military. The FY 2017 NDAA was published jointly by the House Armed Services Committee and Senate Armed Services Committee on 23 December 2016. This legislation marks another important step toward reforming the U.S. defense enterprise to meet current and future threats. The NDAA delivers bold reforms on defense acquisition, military healthcare, military justice, and security cooperation. In addition, the NDAA provided the largest pay raise since 2010, added

funds to address military readiness, and stemmed the drawdown of ground forces. Reform is not easy, but this NDAA shows it is possible. Building on the 2017 NDAA, the Senate, and House Armed Services Committees will likely continue to champion the cause of defense reform in the new Congress.

## Section II National-Level Strategy

### 2-4. President of the United States

The POTUS provides strategic guidance through the National Security Strategy (NSS), National Security Presidential Memorandums (NSPM), executive orders, and other strategic documents in conjunction with additional guidance and refinement from the National Security Council (NSC).

### 2-5. National Security Council

The NSC system, enabled by senior national security advisors, cabinet officials, executive departments and agencies, is the principal POTUS forum for deliberating, coordinating, developing, approving, and implementing national security and foreign policy. The NSC develops policy options, considers implications, coordinates operational problems that require interdepartmental consideration, develops recommendations for the POTUS, and monitors policy implementation. The NSC prepares national security guidance that, with Presidential approval, becomes national security policy, and when implemented, these policy decisions provide the direction for military planning and programming.

### 2-6. National Security Strategy

a. In accordance with Title 50, USC, Section §3043, Annual National Security Strategy Report, the President shall transmit to Congress each year a comprehensive report on the national security strategy of the United States on the date on which the President submits to Congress the budget for the next fiscal year and not later than 150 days after the date on which a new President takes office.

b. Each national security strategy report shall set forth the national security strategy of the United States and shall include a comprehensive description and discussion of the following—

(1) The worldwide interests, goals, and objectives of the United States that are vital to the national security of the United States.

(2) The foreign policy, worldwide commitments, and national defense capabilities of the United States necessary to deter aggression and to implement the national security strategy of the United States.

(3) The proposed short-term and long-term uses of the political, economic, military, and other elements of the national power of the United States to protect or promote the interests and achieve the goals and objectives referred to in paragraph (1).

(4) The adequacy of the capabilities of the United States to carry out the national security strategy of the United States, including an evaluation of the balance among the capabilities of all elements of the national power of the United States to support the implementation of the national security strategy.

(5) Such other information as may be necessary to help inform Congress on matters relating to the national security strategy of the United States.

### 2-7. Unified Command Plan

The Unified Command Plan (UCP), prepared by the CJCS for the POTUS to issue, sets forth basic guidance to all CCDRs. The UCP establishes CCMD missions and responsibilities, delineates geographic areas of responsibility for geographic CCDRs, and specifies responsibilities for functional CCDRs. In accordance with Title 10, USC, Chapter 6—Combatant Commands, Section §161: Combatant Commands: Establishment, requires the following—

a. *Unified and Specified Combatant Commands.* The POTUS, with the advice and assistance of the CJCS and through the SECDEF, shall: establish unified and specified CCMDs to perform military missions; and prescribe the force structure of those commands. (Note: There are two types of CCMDs: geographic, which have responsibility for specific areas; and functional, which have responsibility for executing specific functions).

b. *Periodic Review.*

(1) The Chairman periodically (and not less often than every two years) shall: review the missions, responsibilities (including geographic boundaries), and force structure of each combatant command; and

recommend to the President, through the Secretary of Defense, any changes to such missions, responsibilities, and force structures as may be necessary.

(2) Except during time of hostilities or imminent threat of hostilities, the President shall notify Congress not more than 60 days after: establishing a new combatant command; or significantly revising the missions, responsibilities, or force structure of an existing combatant command.

### **Section III Defense-Level Strategy**

#### **2-8. Secretary of Defense**

For DOD, POTUS decisions drive strategic guidance promulgated by the Office of the Secretary of Defense (OSD). In accordance with Title 10, USC, Section §113—Secretary of Defense, the Secretary of Defense is the head of the Department of Defense, appointed from civilian life by the President, by and with the advice and consent of the Senate. A person may not be appointed as Secretary of Defense within seven years after relief from active duty as a commissioned officer of a regular component of an armed force. A one-time waiver of this provision of law on civilian control of the U.S. military was signed into law on January 20, 2017 to allow retired General James Mattis to serve as Secretary of Defense. The Secretary is the principal assistant to the President in all matters relating to the Department of Defense. Subject to the direction of the President and to this title and Section 2 of the National Security Act of 1947, the Secretary has authority, direction, and control over the Department of Defense.

#### **2-9. Commission on the National Defense Strategy**

a. With the passage of the 2017 National Defense Authorization Act (NDAA), Congress repealed Title 10, USC, Chapter 2—Department of Defense, Section §118 ending the requirement for a Defense Strategic Review (DSR). The DSR had replaced the Quadrennial Defense Review based upon guidance from the 2015 National Defense Authorization Act.

b. In the 2017 NDAA, Congress directed the establishment of a Commission on the National Defense Strategy for the United States. The Commission would be composed of 12 members appointed by the chair and ranking minority members of the Committee on Armed Services of the House of Representatives and Committee on Armed Services of the Senate.

c. The intent of the Commission is to review the current national defense strategy of the United States, including the assumptions, missions, force posture and structure, and strategic and military risks associated with the strategy. The Commission shall conduct a comprehensive assessment of the strategic environment, the threats to the United States, the size and shape of the force, the readiness of the force, the posture and capabilities of the force, the allocation of resources, and strategic and military risks in order to provide recommendations on national defense strategy for the United States.

d. Congress established a timeline for the Commission to submit a final report to the President, the Secretary of Defense, the Committee on Armed Services of the House of Representatives, and the Committee on Armed Services of the Senate

#### **2-10. National Defense Strategy**

a. In accordance with Title 10, USC, Section §113—Secretary of Defense, the SECDEF in January every four years, and intermittently otherwise as may be appropriate, shall provide to the Secretaries of the military departments, the Chiefs of Staff of the armed forces, the commanders of the unified and specified combatant commands, and the heads of all Defense Agencies and Field Activities of the Department of Defense and other elements of the Department and to the congressional defense committees, a defense strategy. Each strategy shall be known as the “national defense strategy”, and shall support the most recent national security strategy report of the President. Each national defense strategy shall including the following:

(i) The priority missions of the Department of Defense, and the assumed force planning scenarios and constructs.

(ii) The assumed strategic environment, including the most critical and enduring threats to the national security of the United States and its allies posed by state or non-state actors, and the strategies that the Department will employ to counter such threats and provide for the national defense.

(iii) A strategic framework prescribed by the Secretary that guides how the Department will prioritize among the threats described in clause (ii) and the missions specified pursuant to clause (i), how the Department will allocate and mitigate the resulting risks, and how the Department will make resource investments.

(iv) The roles and missions of the armed forces to carry out the missions described in clause (i), and the assumed roles and capabilities provided by other United States Government agencies and by allies and international partners.

(v) The force size and shape, force posture, defense capabilities, force readiness, infrastructure, organization, personnel, technological innovation, and other elements of the defense program necessary to support such strategy.

(vi) The major investments in defense capabilities, force structure, force readiness, force posture, and technological innovation that the Department will make over the following five-year period in accordance with the strategic framework described in clause (iii).

b. Further, in accordance with Title 10, USC, Section §113, the Secretary shall seek the military advice and assistance from the Chairman of the Joint Chiefs of Staff in preparing the National Defense strategy. This strategy will be presented to the congressional committees in a classified form with an unclassified summary.

### 2-11. Defense Planning Guidance

In accordance with Title 10, USC, Section §113—Secretary of Defense, the SECDEF, with the advice and assistance of the CJCS, shall provide annually to the Secretaries of the military departments, the Chiefs of Staff of the armed forces, the commanders of the unified and specified combatant commands, and the heads of all Defense Agencies and Field Activities of the Department written policy guidance for the preparation and review of the program recommendations and budget proposals of their respective components to guide the development of forces. Such guidance shall include—

- a. the national security interests and objectives;
- b. the priority military missions of the Department including the assumed force planning scenarios and constructs;
- c. the force size and shape, force posture, defense capabilities, force readiness, infrastructure, organization, personnel, technological innovation, and other elements of the defense program necessary to support the strategy;
- d. the resource levels projected to be available for the period of time for which such recommendations and proposals are to be effective; and
- e. a discussion of any changes in the defense strategy and assumptions underpinning the strategy

### 2-12. Guidance for Employment of the Force

a. The POTUS signs the contingency planning guidance in the SECDEF-signed Guidance for Employment of the Force (GEF), which are both developed by DOD. The GEF transitioned DOD's planning from a contingency-centric approach to a strategy-centric approach. It directs the CCDRs to create theater strategies expressed in single theater campaign plans to achieve prioritized campaign objectives that are in accord with strategic direction from the national level. It also directs that certain contingencies be treated as branches to the theater's single campaign plan. The GEF is developed in parallel with the Joint Strategic Capabilities Plan (JSCP) to ensure complementary guidance from the SECDEF and CJCS. The SECDEF may issue a Strategic Guidance Statement (SGS) or a Planning Order (PLANORD) to update the GEF between publication cycles. An SGS or PLANORD, issued only as needed, may be used to direct DOD to develop options or plans for an emerging crisis or to prevent a situation from becoming a crisis.

b. In accordance with Title 10, USC, Section §113—Secretary of Defense, the SECDEF, with the approval of the POTUS and after consultation with the CJCS, shall provide to the Chairman written policy guidance for the preparation and review of contingency plans, including plans for providing support to civil authorities in an incident of national significance or a catastrophic incident, for homeland defense, and for military support to civil authorities. Such guidance shall be provided every two years or more frequently as needed and shall include guidance on the specific force levels and specific supporting resource levels projected to be available for the period of time for which such plans are to be effective.



## Section IV Global Force Management

### 2-13. Global Force Management Overview

The Global Force Management (GFM) process aligns force assignment, allocation, and apportionment methodologies in support of the DOD's strategic guidance. It provides DOD senior leadership with comprehensive insight into the global availability of forces and risk and impact of proposed force changes.

(a) In accordance with CJCSI 3100.01C, the GFM process provides near-term sourcing solutions while providing the integrating mechanism between force apportionment, allocation, and assignment. It informs DOD's assessment processes by identifying sporadic or persistent unsourced and/or hard to source (UHTS) forces and/or capabilities. Based upon information provided through the Joint Combat Capability Assessment (JCCA), the Global Force Management Board (GFMB) will proactively identify strategic and military risk along with mitigation options.

(b) GFM will also enable the designated Joint Force Providers (JFP) to monitor force availability over time, identify risks to execute combatant command missions, forecast sourcing challenges to execute contingencies, and project Reserve Component unit mobilization and/or availability. See the Global Force Management Implementation Guidance (GFMIG) and the current message for Joint Staff Force Sourcing Business Rules and SECDEF Orders Book (SDOB) Process.

### 2-14. Global Force Management Authorities

In accordance with Joint Publication 5-0, Joint Planning, Appendix E, GFM is a compilation of three related processes: assignment, allocation, and apportionment used to align U.S. forces—

a. *Assignment.* Fulfills the Military Departments, Title 10, USC, Sections 162 responsibility to assign specified forces to CCDRs or to the US Element, North American Aerospace Defense Command as directed by SECDEF to perform missions assigned to those commands. CCDRs exercise combatant command (command authority) over forces assigned to them. Assignment of forces is conducted annually and documented in the GFMIG. This is published bi-annually on even years in the GFMIG and, in the years when the GFMIG is not updated, in a memorandum published separately.

b. *Allocation.* Pursuant to Title 10, USC, Section 162, (3) A force assigned to a CCMD or the United States element of the North American Aerospace Defense Command under this section may be transferred from the command to which it is assigned only by authority of the SECDEF; and under procedures prescribed by the SECDEF and approved by POTUS. Under this authority, the SECDEF allocates forces between CCDRs.

c. *Apportionment.* Apportioned forces provide an estimate of the Military Departments' capacity to generate capabilities that can reasonably be expected to be made available along general timelines. This estimate informs and shapes CCDCR resource informed planning, but does not identify the actual forces that may be allocated for use if a plan transitions to execution. This informs senior leadership's assessment of plans based on force inventory, force generation capacity, and availability. The GEF and GFMIG provide strategic guidance with respect to the apportionment process.

d. Military Departments. Military Department forces required to execute Service institutional activities specified in Title 10, USC are considered "unassigned." The Military Departments are also tasked with providing trained and equipped force to the CCDRs via the allocation process. These forces are designated as "Service retained"

### 2-15. Global Force Management Elements

In accordance with the GFMIG—

a. *Global Force Management Board.* The GFMB is a general officer/flag officer-level body organized by the JS to provide senior DOD leadership the means to assess operational effects of FM decisions and implement strategic planning guidance. The GFMB convenes periodically to address specific recurring tasks, and as required, to address emergent issues. The purpose of GFMB is to: implement the Department's strategic guidance and provide direction for developing force management options and recommendations; serve as a strategic-level review panel to address issues that arise on recommended GFM actions prior to forwarding to CJCS and SECDEF for decision; serve as a strategic-level review panel to annually assess forces/capabilities/individuals that are sporadically or persistently unresourced /hard to source (UHTS) and develop recommendations to address shortfalls; and serve as a strategic-

level review panel to assess current GFM alignment with GEF priorities semiannually and develop recommendations to address imbalances. GFMB membership consists of general officer/flag officer or equivalent Senior Executive Service representation from the JS, CCMDs, the Military Department/Services, OSD agencies, the National Guard Bureau (NGB) and Defense Agencies.

b. *Joint Force Providers*. CCDRs with assigned forces, the Secretaries of the Military Departments (MILDEP), DOD Agencies, and OSD organizations that provide force sourcing solutions to CCDRs force requirements are JFPs. They include—

(1) *Joint Staff, J35*. The CJCS, through the Director, J3 (DJ3), will serve as the JFP responsible for providing recommended sourcing solutions for all validated force and joint individual augmentee (JIA) requirements and as the JFP for conventional forces. DJ3 coordinates with the Secretaries of the Military Departments, CCDRs, JFPs, joint force managers (JFM), and DOD agencies to identify and recommend global conventional joint sourcing solutions (military and DOD civilian); coordinate force requests that include both general purpose forces (GPF) and special operations forces (SOF) capabilities; and to develop and recommend conventional JIA sourcing solutions for joint HQ, SECDEF-directed missions, and U.S. individuals contributions to NATO Crisis Establishments.

(2) *U.S. Special Operations Command (USSOCOM)*. USSOCOM serves as the JFP for SOF. USSOCOM coordinates with the Military Departments/Services, CCDRs, JFPs, and DOD Agencies to identify and recommend global SOF sourcing solutions. For force requests that include GPF and SOF capabilities, USSOCOM coordinates with its components, Military Departments/Services, and the JS to identify and recommend global sourcing solutions.

(3) *U.S. Transportation Command (USTRANSCOM)*. USTRANSCOM serves as the JFP for mobility forces. Mobility forces are defined as personnel, equipment, and unique support required to execute command and control, and execute air and surface common user lift operations, including capabilities required for port opening, deployment, redeployment, and distribution activity. USTRANSCOM will coordinate with Military Departments/Services, CCDRs, JFPs, and DOD Agencies to identify and recommend global mobility sourcing solutions.

(4) *U.S. Strategic Command (USSTRATCOM)*. USSTRATCOM serves as the JFM for intelligence, surveillance, and reconnaissance (ISR) and coordinates with Military Department/Services, CCDRs, and intelligence agencies to identify and recommend, through the JFCs, joint global ISR sourcing solutions including processing, exploitation, and dissemination (PED) capabilities. USSTRATCOM also serves as the JFM for integrated missile defense (IMD) and coordinates with Military Department/Services, CCDRs, and DOD agencies to identify and recommend, through the JFCs, global DOD missile defense sourcing solutions. The joint functional component command for ISR (JFCC ISR) and for IMD (JFCC IMD), are both assigned to CDRUSSTRATCOM.

(5) *U.S. Cyber Command (USCYBERCMD)*. Section 923 of the FY 2017 NDAA required the President to establish a unified combatant command for cyber operating forces. A President Memorandum to the Secretary of Defense on August 18, 2017 directed that U.S. Cyber Command be established as a Unified Combatant Command and assigned all of the cyberspace-related responsibilities previously assigned to Commander, U.S. Strategic Command. The authorities and responsibilities for U.S. Cyber Command will be included in the next update to the Unified Command Plan.

## 2-16. Global Force Management Request for Forces and / or Request for Capabilities

In accordance with the GFMIG, emergent requirements are requests from a CCDR, USELEMNORAD or NATO for units and capabilities that were not anticipated at the time of the CCDR's annual submission and cannot be met by the requesting HQ, its components, or their assigned and allocated forces. The CCDR submits RFFs via the Joint Capabilities Requirements Manager (JCRM) and record message (RMG) simultaneously.

a. *Request for Forces Required Elements*. RFF required elements include: unit capability (standard and non-standard); unit quantity; force tracking number (FTN); destination; deployment dates; deployment duration; mission justification; and special requirements.

b. *Emergent Request for Forces Staffing*.

(1) ACOMs, ASCCs, and DRUs deployed in a CCMD or responsible for a named operation that is in need of a capability will “define” the emergent requirement.

(2) Joint Task Force (JTF) or component command staff will “review” the RFF.

(3) JTF CDR or component commander will “endorse” the RFF.

(4) The CCDR or designated representative (e.g., J3) will “approve” the RFF and assign an RFF identification number (RFFID).

(5) The JS J3 will “validate” the RFF and “assign” the GEF priority and Joint Functional Commander (JFC) / JFP. JS J1 will “validate” emergent JIA requests to existing or approved Joint Manning Documents (JMD).

(6) The JFPs will “nominate” the best available sourcing solution from their forces.

(7) The JFC / JFP will “recommend” the best available JFP and force with an achievable latest arrival date (LAD).

(8) The SECDEF will “order” the sourcing recommendation in the SDOB and corresponding GFM Allocation Plan (GFMAP) modifications with an ordered LAD.

(9) The CCDR will “issue C2” language via deployment orders (DEPORD).

c. *Emergent Request for Forces Categories*. There are three emergent RFF categories: routine, urgent, and immediate.

(1) Routine RFFs have LADs for requested forces that are 120 days or greater from the date time group (DTG) on the RFF message (e.g., “routine emergent” requests for JIAs).

(2) See the GFMIG for classified descriptions of urgent and immediate RFF categories.

## 2-17. Global Force Management Outputs

a. *Global Force Management Allocation Plan*. The GFMAP is the Secretary of Defense deployment order, prepared by the CJCS, that authorized force allocations and deployment of forces in support of CCMD force and JIA requirements. The JS will seek SECDEF approval to deploy rotational and emergent forces in support of CCDR requests via GFMAP base DEPORD and subsequent modifications. Rotational forces are submitted annually. The DJ3 is responsible for developing the GFMAP, for briefing it to the SECDEF for approval, and for publishing the GFMAP once approved.

b. *Global Force Management Implementation Guidance*. The GFMIG integrates complementary assignment, apportionment, and allocation information into a single GFM document. The GFMIG provides a single reference for planners and leaders to integrate standing forces, rotational forces and potential contingency forces into comprehensive planning activities. The GFMIG provides SECDEF direction for assigning forces to CCMDs to accomplish CCDRs’ assigned missions; outlines the allocation process that provides access to forces/capabilities when assigned mission requirements exceed the capacity and or capability of the assigned or allocated forces; provides apportionment guidance and force apportionment tables to facilitate planning and informs the Joint Force, structure, and capability assessment processes.

c. *Secretary of Defense Orders Book*. The Secretary of Defense Orders Book (SDOB) modifies the GFMAP base DEPORD. Non-urgent RFFs and alert / mobilizations that require SECDEF approval will be processed in a bi-weekly cycle.

d. *Special Book*. All time-sensitive requests for forces and alert / mobilizations will be staffed as a “special book” and briefed to the SECDEF upon completion of the standard, but expedited, staffing process.

## 2-18 Global Force Management Interagency Process

In accordance with the GFMIG, although GFM does not manage the entire collection capabilities in all branches of government, GFM interacts with the interagency process by providing a conduit to non-DOD agencies to meet CCDR capability requests, for both planned and executed operations. As other (non-DOD) instruments of national power are committed to support CCDR capability requests, the GFMAP provides a vehicle to inform the Joint Planning and Execution Community (JPEC) of the directed sourcing solution.

## Section V Joint-Level Strategy

### 2-19. Chairman of the Joint Chiefs of Staff

a. POTUS and DOD decisions and strategic guidance are influenced by the Chairman’s use of the Joint Strategic Planning System (JSPS). To carry out Title 10, USC, statutory responsibilities, the CJCS utilizes the JSPS to provide a formal structure in aligning ends, ways, and means, and to identify and

mitigate risk for the military in shaping the best assessments, advice, and direction of the Armed Forces when advising the POTUS and the SECDEF. In accordance with Title 10, USC, Subtitle A—General Military Law, Part I—Organization and General Military Powers, Chapter 5—Joint Chiefs of Staff, Section §153. Chairman: Functions, Planning; Advice; Policy Formulation. Subject to the authority, direction, and control of the President and the Secretary of Defense, the Chairman of the Joint Chiefs of Staff shall be responsible for the following—

(1) *Strategic Direction*. Assisting the President and the Secretary of Defense in providing for the strategic direction of the armed forces.

(2) *Strategic and Contingency Planning*.

(3) *Global Military Integration*.

(4) *Comprehensive Joint Readiness*.

(5) *Joint Capability Development*

(6) *Joint Force Development Activities*.

(7) *Other Matters*.

b. Under the above categories two through seven, there are 28 specific responsibilities identified many of which are discussed later. Further, under Section 153 there are specific requirements on what the National Military Strategy (NMS) must address, when the Chairman must review or provide an update to the NMS, and how risk in the NMS needs to be assessed, all of which are discussed later in this chapter. There is also specific guidance on what needs to be in an annual report the Chairman provides to Congress on Combatant Command Requirements and when this report must be submitted.

## 2-20. Joint Strategic Planning System

JSPS is the primary formal means the Chairman uses to meet his statutory responsibilities broadly identified in the paragraph 3-19 and illustrated in Figure 2-2. Materiel that covers the JSPS is taken directly from the Chairman of the Joint Chief of Staff Instruction 3100.01C and from sections in Title 10 U.S. Code.

a. Title 10, USC, Armed Forces, sections 113(g)(1), 113(g)(2), 151, 153, 161, 163, 165, 166, 181 and Titles 22 and 50 direct the Chairman of the Joint Chiefs of Staff to provide independent assessments as principal military advisor to the President, the NSC, HSC, and the Secretary of Defense; and to assist in providing unified strategic direction to the Armed Forces on behalf of the President and Secretary of Defense.

b. On 20 November 2015, the Chairman of the Joint Chiefs of Staff Instruction (CJCSI) 3100.01C was published and reflects the Chairman's guidance and changes to Global Force Management, Joint Force Development (JFD) and JSCP. The CJCSI provides a description of the system by which the Chairman works with OSD, Services, CCMDs, and support agencies to execute his statutory responsibilities. The current CJCSI is under review and revision to address changes directed by the current CJCS.

c. The JSPS is how the Chairman carries out his statutory responsibilities. The Chairman's primary roles are to assess, advise, direct, and execute. Some of the statutory responsibilities delineated in USC involve more than one of the Chairman's primary roles. The JSPS provides structure for the Chairman to interact with National, Congressional, and DOD processes.

## 2-21. Joint "Assess" Strategic Documents

The Chairman conducts both deliberate and continuous assessments. These assessments provide an annual review of the strategic environment with friendly and threat capabilities. Services and CCMDs prepare annual assessments for the Chairman across missions, domains, and time. These assessments, coupled with internal Joint Staff assessments, provide a strong analytic basis for developing options and enabling the Chairman to meet comprehensive assessment, title 10 responsibilities. These assessments include the Comprehensive Joint Assessment (CJA), the Joint Strategy Review (JSR) process, the Chairman's Risk Assessment (CRA), Joint Strategic Assessment (JSA), and the Chairman's Readiness System (CRS). These processes comprise key parts of the Chairman's assessment component of the JSPS.

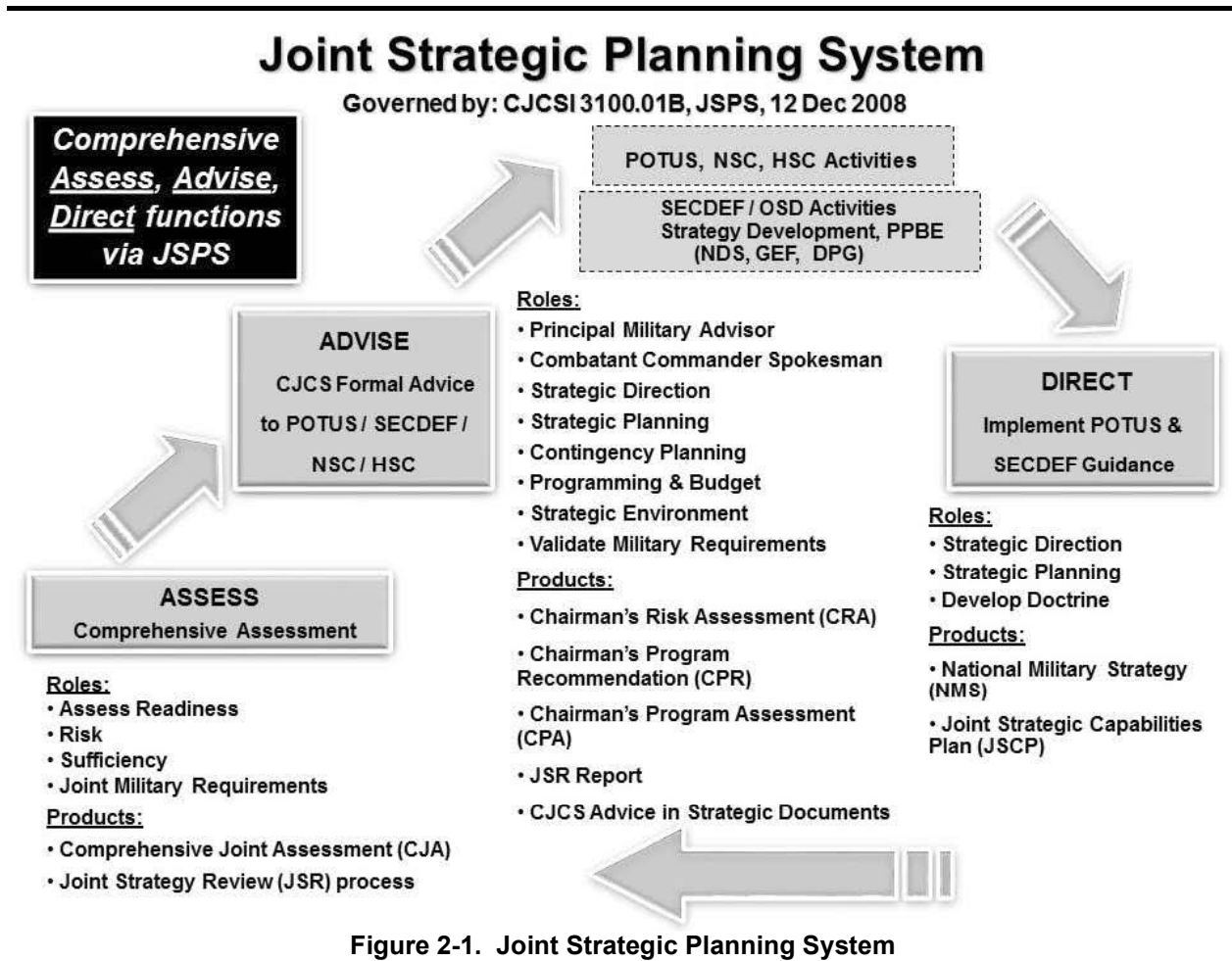

a. *Comprehensive Joint Assessment (CJA)*. In accordance with CJCSI 3100.01C, the CJA is a formal holistic strategic assessment process that provides a common informational baseline and strategic picture. The CJA provides a central unified mechanism for CCDRs and Services Chiefs to describe the strategic environment, their opportunities, challenges, ability to execute and support steady state Campaign Plan missions and surge to meet Contingency Plan objectives, with associated military risks and priority capability and force requirements. The CJA is comprised of Joint Staff queries that facilitates integrated CCMD, Service, and Joint staff analysis.

b. *Joint Strategy Review (JSR) Process*. In accordance with CJCSI 3100.01C, the JSR process is designed to provide a comprehensive and cogent analytical framework that enables exploration of areas of strategic interest and supports the preparation of CJCS products such as strategic documents, directives, instructions, or memorandum. This process captures critical aspects of the strategic environment (e.g. trends, variables, and challenges) along with their national security and military implications. The JSR synthesizes CJA information independent studies, and Joint Staff functional estimates to inform the Chairman's advice and direction. Insights are captured in Joint Staff working papers and in specialized activities.

c. *Chairman's Risk Assessment (CRA)*. In accordance with CJCSI 3100.01C, the CRA is informed by the full scope of the JSR process and provides Congress with the Chairman's assessment of the nature and magnitude of strategic and military risk in executing the objectives called for in the NMS. The CRA provides a holistic assessment of the ability of the Armed Forces to meet strategic requirements in the near-term. The CRA also gives the Chairman a way to transmit formal military advice to the SECDEF and Congress. The Chairman provides input and advice to the SECDEF's subsequent Risk Mitigation Plan (RMP) report to Congress.

d. *Joint Strategic Assessment (JSA)*. In accordance with CJCSI 3100.01C, the JSA provides a strategic environment overview and addresses the mid- and far-term strategic environment, which informs the JSR baseline.

e. *The Chairman's Readiness System (CRS)*. The CRS provides a common framework to conduct commanders' readiness assessments and enables leadership to: gain greater visibility on readiness issues across the CCMDs, Services, and Combat Support Agencies (CSA); synchronize staff actions; gain consensus more quickly; and streamline risk mitigation solutions to warfighters. Components of this readiness system are the Joint Forces Readiness Review, the Joint Combat Capability Assessment and Plan Assessment, and the Quarterly Readiness Report to Congress.

### 2-22. Joint "Advise" Strategic Documents

The Chairman conveys best military advice to the President, SECDEF, NSC, and Congress. The Chairman's formal advice assists National Security, National Defense and Interagency leadership and their staffs in the development of National Security and Defense strategies; DOD planning programming, budgeting document and activities; as well as informs Service Strategic Plans and Program Objective Memorandum (POM). The Chairman also has routine political-military interaction with the President and SECDEF outside the formal JSPS process.

a. *Joint Strategy Estimate (JSE) Report*. In accordance with CJCSI 3100.01C, the JSE report sets a strategic environment baseline and generated a common strategic picture, which informs the full range of JSPS activities. It is considered an output of the comprehensive joint assessment (see Assess Section).

b. *National Military Strategy*. In accordance with CJCSI 3100.01C, the NMS primarily serves to transmit direction to the Armed Forces, but is also a way to transmit the Chairman's formal military advice. The NMS details the Chairman's view of the global strategic environment, the implications of that environment, and ways the military can best accomplish the goals of the NSS and the NDS given adequate resources and means.

(1) In accordance with Title 10, USC, Subtitle A—General Military Law, Part I—Organization and General Military Powers, Chapter 5—Joint Chiefs of Staff, Section §153—Chairman: Functions, the Chairman shall determine each even-numbered year whether to prepare a new National Military Strategy in accordance with this paragraph or to update a strategy previously prepared in accordance with this paragraph. Each National Military Strategy (or update) shall be based on a comprehensive review conducted by the Chairman in conjunction with the other members of the Joint Chiefs of Staff and the commanders of the unified and specified combatant commands.

(2) Each National Military Strategy (or update) shall describe how the military will support the objectives of the United States as articulated in the most recent National Security Strategy, the most recent annual report of the Secretary of Defense to the President and Congress, the most recent national defense strategy presented by the Secretary of Defense, the most recent policy guidance provided by the Secretary of Defense, and any other national security or defense strategic guidance issued by the President or the Secretary of Defense.

(3) Each National Military Strategy (or update) at a minimum shall: assess the strategic environment, threats, opportunities and challenges that affect the national security of the United States; assess military ends, ways and means to support the objectives of the United States; provide the framework for the assessment by the Chairman of military strategic and operational risks, and for the development of risk mitigation options; develop military options to address threats and opportunities; assess joint force capabilities, capacities, and resources; and establish military guidance for the development of the joint force and the total force building on guidance by the President and Secretary of Defense..

(4) The NMS establishes priority ways, given national ends and defense means.

c. *Chairman's Risk Assessment*. In accordance with CJCSI 3100.01C, the CRA is primarily an assessment report, which also gives the Chairman a means of transmitting formal military advice to the SECDEF and Congress. The Chairman provides input and advice to the SECDEF subsequent Risk Mitigation Plan report to Congress. Congress provides specific guidance on this risk assessment as explained below.

(1) In accordance with Title 10, USC, Subtitle A—General Military Law, Part I—Organization and General Military Powers, Chapter 5—Joint Chiefs of Staff, Section §153—Chairman: Functions, the Chairman shall prepare each year an assessment of the risks associated with the most current National Military Strategy (or update).

(2) The Risk Assessment shall do the following: as the Chairman considers appropriate, update any changes to the strategic environment, threats, objectives, force planning and sizing constructs, assessments, and assumptions that informed the National Military Strategy required by this section; identify and define the military strategic and operational risks to United States interests and the military strategic and operational risks in executing the National Military Strategy; identify and define levels of risk including an identification of what constitutes "significant" risk in the judgment of the Chairman; identify and assess risk in the National Military Strategy by category and level and the ways in which risk might manifest itself, including how risk is projected to increase, decrease, or remain stable over time; and for each category of risk, assess the extent to which current or future risk increases, decreases, or is stable as a result of budgetary priorities, tradeoffs, or fiscal constraints or limitations as currently estimated and applied in the most current future-years defense program; identify and assess risk associated with the assumptions or plans of the National Military Strategy about the contributions of external support as appropriate; and identify and assess the critical deficiencies and strengths in force capabilities (including manpower, logistics, intelligence, and mobility support) identified during the preparation and review of the contingency plans of each unified combatant command, and identify and assess the effect of such deficiencies and strengths for the National Military Strategy.

(3) In accordance with CJCSI 3100.01C, the CRA is primarily as assessment report which also gives the Chairman a means of transmitting formal military advice to the SECDEF and Congress. The Chairman provides input and advice to the SECDEF subsequent Risk Mitigation Plan report to.

*d. Chairman's Program Recommendation.*

(1) In accordance with Title 10, USC, Subtitle A—General Military Law, Part I—Organization and General Military Powers, Chapter 5—Joint Chiefs of Staff, Section §153—Chairman: Functions, the Chairman shall advise the Secretary on the priorities of the requirements identified by the commanders of the unified and specified combatant commands.

(2) In accordance with CJCSI 3100.01C, the CPR serves as the Chairman's advice on capabilities, programs, and budget considerations to the Secretary of Defense. The CPR informs the SECDEF's fiscal guidance and influences the DPG. The CPR is developed in accordance with CJCSI 8501 and provides the Chairman's programmatic advice to the SECDEF and input to the Department's resource priorities.

*e. Chairman's Program Assessment.* In accordance with Title 10, USC, Subtitle A—General Military Law, Part I—Organization and General Military Powers, Chapter 5—Joint Chiefs of Staff, Section §153—Chairman: Functions, the Chairman shall—

(1) Advise the Secretary on the extent to which the program recommendations and budget proposals of the military departments and other components of the Department of Defense for a fiscal year conform with the priorities established in national defense strategies and with the priorities established for the requirements of the unified and specified combatant commands.

(2) Advise the Secretary on alternative program recommendations and budget proposals, within projected resource levels and guidance provided by the Secretary, in order to achieve greater conformance with priorities established in national defense strategies and with the priorities established for the requirements of the unified and specified combatant commands.

(3) Recommend to the Secretary a budget proposal for activities of each unified and specified combatant command.

(4) Assessing joint military capabilities and identifying, approving and prioritizing gaps in such capabilities to meet the national defense strategies.

(5) Recommend to the Secretary appropriate trade-offs among life-cycle cost, schedule, and performance, and procurement quantity objectives in the acquisition of materiel and equipment to support the strategic and contingency plans required by this paragraph in the most effective and efficient manner.

(6) In accordance with CJCSI 3100.01C, the CPA provides the Chairman's personal assessment and advice to the SECDEF on the conformance of Service and agency POMs to priorities established in strategic guidance, strategic plans, and by CCDR requirements. The CPA may be accomplished through the processes and documents that bring forth the analysis and recommendations of the Joint Staff Program and Budget Review (PBR).

## **2-23. Joint "Direct" Strategic Documents**

In accordance with CJCSI 3100.01C, the Chairman assists the President and SECDEF in providing unified strategic direction to the Armed Forces by linking national strategic objectives to military strategy, plans, resources, doctrine, and the Joint activities required to implement them. The Chairman's strategic

guidance is issued in the NMS, Joint Strategic Capability Plan (JSCP), Capstone Concept for Joint Operations (CCJO), and Joint Training Guidance (JTG). The Chairman also issues formal guidance to the Joint Staff or the Joint Force that encapsulates vision, priorities, and specific direction on targeted issues. These guidance documents and other CJCS guidance enable the Chairman to meet unified direction, title 10 responsibilities.

a. *National Military Strategy*. The NMS can provide both classified and unclassified direction to the Armed Forces in support of the national security and defense strategies. National and defense strategies provide “the what,” and the NMS provides the “how” in aligning ends, ways, means, and risk to accomplish the missions called for in support of U.S. national interests and objectives. The NMS focuses the efforts of the Armed Forces of the United States, while conveying the Chairman’s advice to the President, SECDEF, and Congress, with regard to the security environment and the necessary military actions to protect vital U.S. national security interests. The NMS informs CCDR employment of the Joint Force to protect vital U.S. interests and the Service Chiefs’ force development. It also informs allies, partners, and adversaries on military strategy and can amplify NSS or NDS messages. The CRA and NMS are based upon the National Military Objectives described in the NMS per statute.

b. *Joint Strategic Capabilities Plan*. The JSCP provides specific guidance to commanders, directors and their staffs by translating strategic policy end states from the GEF into military campaign and contingency plan guidance. Additionally, it apportions forces for planning based upon the knowledge of current and projected force deployments in support of ongoing operations.

(1) In accordance with Title 10, USC, Subtitle A—General Military Law, Part I—Organization and General Military Powers, Chapter 5—Joint Chiefs of Staff, Section §153—Chairman: Functions, the CJCS shall be responsible for Strategic Direction, Strategic and Contingency Planning, Global military integration, Comprehensive Joint Readiness, Joint Capability Development and Joint Force Development Activities, which includes—

(a) Developing strategic frameworks and preparing strategic plans, as required, to guide the use and employment of military force and related activities across all geographic regions and military functions and domains and to sustain military efforts over different durations of time, as necessary.

(b) Performing military net assessments of the joint capabilities of the armed forces of the United States and its allies with the capabilities of potential adversaries.

(c) Advising the Secretary on the allocation and transfer of forces among geographic and functional combatant commands, as necessary, to address trans-regional, multi-domain, and multifunctional threats.

(d) Providing for the preparation and review of contingency plans which conform to policy guidance from the President and the Secretary of Defense.

(e) Preparing joint logistic and mobility plans to support national defense strategies and recommending the assignment of responsibilities to the armed forces in accordance with such plans.

(f) Advising the Secretary on the missions and functions that are likely to require contractor or other external support to meet national security objectives and policy and strategy, and the risks associated with such support.

(g) Advising the Secretary on critical deficiencies and strengths in joint force capabilities (including manpower, logistic, and mobility support) identified during the preparation and review of national defense strategies and contingency plans and assessing the effect of such deficiencies and strengths on meeting national security objectives and policy and on strategic plans.

(h) Establishing and maintaining, after consultation with the commanders of the unified and specified combatant commands, a uniform system of evaluating the preparedness of each such command, and groups of commands collectively, to carry out missions assigned to the command or commands.

(2) In accordance with CJCSI 3100.01C, the JSCP provides formal planning guidance to the Joint Force to operationalize the strategic vision described in the NMS. The JSCP consists of direction to the Joint Force, implementing and augmenting the President’s and the SECDEF’s guidance found in the GEF, the UCP, the NDS, the NSS and the Chairman’s guidance found in the NMS. Planning guidance related to CCMD campaign plans, contingency plans, security cooperation, posture, mobilization, steady-state and contingency global force management and simultaneity. Tasks to CCMDs, Services, NGB, the Joint Staff, and certain agencies to prepare applicable campaign and contingency plans and to support integrated planning. The identification of roles, responsibilities, and tasks to support planning integration across CCMDs and supplemental instructions for specific functions.

c. *Capstone Concept for Joint Operations*. The CCJO is the Chairman’s vision for the future Joint Force. It describes how the future joint force will operate within the context of strategic guidance and the



future strategic security environment and identifies implications to guide Joint Force development. The CCJO establishes a bridge from strategic guidance to subordinate joint and Service concepts, force development activities, and follow-on doctrine. The Chairman revises the CCJO as needed.

d. *Chairman's Joint Training Guidance (CJTG)*. The CJTG is an annual notice that provides guidance to all DOD Components for the planning, execution and assessment of joint, individual, and collective training for a four-year period. The CJTG applies to CCMDs, Services, the NGB, CSAs, Joint Staff directorates, and other Joint organizations. As an element of the JSPS, the CJTG is intended to support development of Joint Training Plans (JTP). It may also guide adjustments to scheduled training events and objectives to address emerging operational concerns, and the Chairman's High Interest Training Issues (HITI).

## 2-24. Joint "Execute" Strategic Documents

In accordance with CJCSI 3100.01C, the Chairman assists the President and SECDEF in providing unified strategic direction to the Armed Forces. The Chairman assists the President and the SECDEF by translating their direction into coordinated military missions, tasks, and activities. The Chairman executes statutory responsibilities to assist the President and SECDEF with their command function through Joint Force Development and planning activities; Global Force Management Board (GFMB) activities; producing the Secretary's Orders Book (SOB); validating Joint requirements via the Joint Requirements Oversight Council (JROC); and conducting strategic analyses. The Joint Staff plays a central role enabling the Chairman to meet effective execution, title 10 responsibilities.

a. *Capabilities Development and Resourcing (OPR: J-8)*. The Chairman uses the JROC as an advisory council to help fulfill title 10 responsibilities to provide advice to the SECDEF on requirements prioritization and the conformity of programs and budgets to priorities established both in strategic plans and those identified by the CCMDs. The Chairman executes the Joint Capabilities and Integration Development System (JCIDS) process to validate and prioritize requirements.

b. *Joint Force Development (OPR: J-7)*. On behalf of the Chairman, the Joint Staff manages Joint Concept Development, Joint Doctrine, Joint Education, Joint Training, Joint Lessons Learned, Joint and Coalition Operational Analysis Programs. Joint Force Development non-materiel solutions, identified through these programs, are incorporated into the JCIDS process to mitigate and solve joint warfighting capability gaps.

c. *Joint Operation Planning and Execution System (JOPES) (OPR: J-3)*. JOPES is an overarching, comprehensive system encompassing the full spectrum of processes, procedures, and actions supporting every facet of the planning, decision-making, and execution continuum. JOPES applies to the development and implementation of operation plans and orders prepared in response to the President, SECDEF, or Chairman, and specifies the policies, procedures, and format for developing and executing plans. JOPES includes sub-processes for mobilization, deployment, employment, sustainment, redeployment, and demobilization.

d. *Adaptive Planning and Execution (APEX) (OPR J-3)*. Department level system encompassing policy, process, procedures, and supported by communication and information technology being developed by OSD and the joint planning and execution community to plan, monitor, and execute Joint Operations. APEX will replace JOPES in the future.

e. *Planning, Programming, Budgeting, and Execution System (PPBES) (OPR: J-8)*. The Chairman, CCMDs, Services, and Joint Staff execute a wide range of activities within PPBES (See CJCSI 8501.01 series). The CPR, CPA, and CRA provide advice or assessments that inform PPBES. The NMS and JSCP provide planning direction that is reflected within PPBES.

## 2-25. Combatant Commands

a. In accordance with Title 10, USC, Subtitle A—General Military Law, Part I—Organization and General Military Powers, Chapter 6—Combatant Commands, Section §162—Combatant Assigned Forces; Chain of Command, the Secretaries of the military departments shall assign specified forces under their jurisdiction to unified and specified combatant commands or to the United States element of the North American Aerospace Defense Command to perform missions assigned to those commands. The SECDEF shall ensure that such assignments are consistent with the force structure prescribed by the President for each combatant command. A force not assigned to a combatant command or the United States element of the North American Aerospace Defense Command shall remain assigned to the military department concerned with carrying out the responsibilities of the Secretary of the military

department concerned. A force assigned to a combatant command or to the United States element of the North American Aerospace Defense Command may be transferred from the command to which it is assigned only by authority of the SECDEF and under procedures prescribed by the SECDEF and approved by POTUS.

b. Except as otherwise directed by the SECDEF, all forces assigned to a unified combatant command shall be under the command of, the commander of that command. The preceding sentence applies to forces assigned to a specified combatant command only as prescribed by the SECDEF.

c. Unless otherwise directed by POTUS, the chain of command to a unified or specified combatant command runs from POTUS to the SECDEF; and from the SECDEF to the commander of the combatant command. The CCDR is responsible to POTUS and to the SECDEF for the performance of missions assigned to that command by the POTUS or by the SECDEF with the approval of POTUS. Subject to the direction of POTUS, the CCDR performs his duties under the authority, direction, and control of the SECDEF and is directly responsible to the SECDEF for the preparedness of the command to carry out missions assigned to the command.

d. CCDRs assist the CJCS in his “assess” role by: providing information as requested through the CJA; include readiness reporting via the Joint Forces Readiness Review (JFRR) and DRRS processes as inputs to the JCCA process; providing assessments of capability gaps and excesses, policy and planning issue documents, as requested by the Chairman to the Joint Staff and participating in the CGA process; provide capability analysis and assessment on joint concepts through the CJA and provide participants to JROC forums.

e. CCDRs assist the CJCS in his “advise” role by: developing and providing capability requirements documents as required in CJCSI 3170.01.

f. CCDRs assist the CJCS in his “direct” role by: implementing the JSCP and other orders as directed and transmitted on behalf of the President or the Secretary of Defense; implementing direction included with CJCS funding of special programs; implementing procedures or policies as described in CJCSIs and CJCSMs.

g. CCDRs assist the CJCS in his “execute” role by: leading current operations in response to EXORDs; participate in the GFM process; participate in JCIDS; and meet Joint Strategic Capabilities Plan requirements.

h. There are currently six geographic and four functional CCMDs (see Fig 2-2).

(1) U.S. Africa Command (USAFRICOM). USAFRICOM is responsible to the SECDEF for military relations with African nations, the African Union, and African regional security organizations. A full-spectrum CCMD, U.S. AFRICOM is responsible for all DOD operations, exercises, and security cooperation on the African continent, its island nations, and surrounding waters.

(2) U.S. Central Command (USCENTCOM). USCENTCOM's area of responsibility spans more than 4 million square miles and consists of the intersection of three continents and globally vital commercial seal lanes, flight corridors, pipelines and overland routes. The 20 nations of the AOR stretch from Northeast Africa across the Middle East to Central and South Asia.

(3) U.S. European Command (USEUCOM). USEUCOM is one of the United States' two forward-deployed geographical CCMDs, whose area of focus covers almost one-fifth of the planet, including all of Europe, large portions of Asia, parts of the Middle East and the Arctic and Atlantic Oceans. The command is responsible for U.S. military relations with NATO and 51 countries on two continents with a total population of close to a billion people.

(4) U.S. Pacific Command (USPACOM). USPACOM area of responsibility encompasses about half the earth's surface, stretching from the waters off the west coast of the United States to the western border of India, and from Antarctica to the North Pole. There are few regions as culturally, socially, economically, and geo-politically diverse as the Asia-Pacific. The 36 nations that comprising the Asia-Pacific region are home to more than 50% of the world's population, 3,000 different languages, several of the world's largest militaries, and five nations allied with the U.S. through mutual defense treaties. Two of the three largest economies are located in the Asia-Pacific along with 10 of the 14th smallest. The AOR includes the most populous nation in the world, the largest democracy, and the largest Muslim-majority nation. More than one third of Asia-Pacific nations are smaller, island nations that include the smallest republic in the world and the smallest nation in Asia.

## Unified Combatant Commands

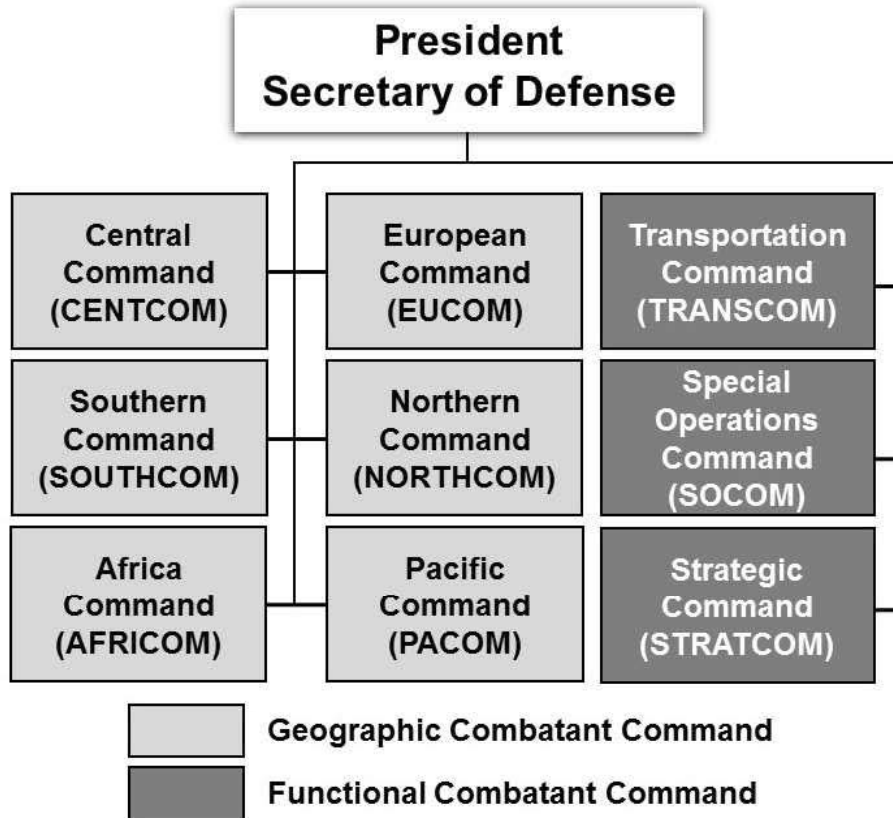

Figure 2-2. Unified Combatant Commands

(5) U.S. Special Operations Command (USSOCOM). USSOCOM synchronizes the planning of Special Operations and provides Special Operations Forces to support persistent, networked and distributed Global Combatant Command operations in order to protect and advance our Nation's interests.

(6) U.S. Southern Command (USSOUTHCOM). USSOUTHCOM is responsible for providing contingency planning, operations, and security cooperation in its assigned area of responsibility which includes Central America, South America, and the Caribbean (except U.S. commonwealths, territories, and possessions). USSOUTHCOM is responsible for the force protection of U.S. military resources at these locations. USSOUTHCOM is also responsible for ensuring the defense of the Panama Canal.

(7) U.S. Strategic Command (USSTRATCOM). USSTRATCOM integrates and coordinates the necessary command and control capability to provide support with the most accurate and timely information for POTUS, the SECDEF, other national leadership and CCDRs. USSTRATCOM combines the synergy of the U.S. legacy nuclear command and control mission with responsibility for: space operations; global strike; global missile defense; and global command, control, communications, computers, intelligence, surveillance, and reconnaissance (C4ISR). This dynamic command gives national leadership a unified resource for greater understanding of specific threats around the world and the means to respond to those threats rapidly.

(8) U.S. Transportation Command (USTRANSCOM). USTRANSCOM is a unified, functional combatant command which provides support to the eight other U.S. combatant commands, the military services, defense agencies and other government organizations. USTRANSCOM provides full-spectrum global mobility solutions and related enabling capabilities for supported customers' requirements in peace and war.

(9) U.S. Northern Command (USNORTHCOM). USNORTHCOM partners to conduct homeland defense, civil support and security cooperation to defend and secure the United States and its interests.

USNORTHCOM's area of responsibility includes air, land and sea approaches and encompasses the continental United States, Alaska, Canada, Mexico and the surrounding water out to approximately 500 nautical miles. It also includes the Gulf of Mexico, the Straits of Florida, and portions of the Caribbean region to include The Bahamas, Puerto Rico, and the U.S. Virgin Islands.

(10) U.S. Cyber Command (USCYBERCMD). Section 923 of the FY 2017 NDAA required the President to establish a unified combatant command for cyber operating forces. A President Memorandum to the Secretary of Defense on August 18, 2017 directed that U.S. Cyber Command be established as a Unified Combatant Command and assigned all of the cyberspace-related responsibilities previously assigned to Commander, U.S. Strategic Command. The authorities and responsibilities for U.S. Cyber Command will be included in the next update to the Unified Command Plan.

### Section VI Joint Planning

#### 2-26. Joint Planning Overview

In accordance with JP 5-0, Joint Planning—

a. Joint planning is the deliberate process of determining how (the ways) to use military capabilities (the means) in time and space to achieve objectives (the ends) while considering the associated risks. Ideally, planning begins with specified national strategic objectives and military end states to provide a unifying purpose around which actions and resources are focused. At the combatant command (CCMD) level, joint planning serves two critical purposes:

(1) At the strategic level, joint planning provides the President and Secretary of Defense (SECDEF) options, based on best military advice, on use of the military in addressing national interests and achieving the objectives in the National Security Strategy and National Defense Strategy.

(2) At the operational level, once strategic guidance is given, planning translates this guidance into specific activities aimed at achieving strategic and operational-level objectives and attaining the military end state.

b. Joint planning plays a fundamental role in securing the Nation's interests in a continuously changing operational environment (see Fig 2-3). Through structured review, assessment, and modification, plans are constantly assessed and updated by the JFC and reviewed by the broader JPEC and senior DOD leadership. The open and collaborative planning process provides common understanding across multiple levels of organizations and the basis for adaptation and change.

c. Joint planning begins when an appropriate authority recognizes potential for military capability to be employed in support of national objectives or in response to a potential or actual crisis. At the strategic level, that authority—the POTUS, SECDEF, or CJCS—initiates planning by deciding to develop military options. Presidential directives, NSS, UCP, GEF, JSCP, and related strategic guidance documents (e.g. strategic guidance statements) serve as the primary guidance to begin planning. Analyses of developing or immediate crises may result in the POTUS, SECDEF, or CJCS initiating military planning through a warning order or other planning directive.

#### 2-27. Joint Planning and Execution Community

In accordance with JP 5-0, Joint Planning, the headquarters, commands, and agencies involved in joint planning or committed to a joint operation are collectively termed the JPEC. Although not a standing or regularly meeting entity, the JPEC consists of the stakeholders shown in Figure 2-4.

#### 2-28. Adaptive Planning and Execution Enterprise

In accordance with JP 5-0, Joint Planning—

a. Strategy and joint planning occur within adaptive planning and execution (APEX), the department-level enterprise of policies, processes, procedures, and reporting structures supported by communications and information technology used by the JPEC to plan and execute joint operations. APEX integrates the planning activities of the JPEC and facilitates the transition from planning to execution. APEX activities span many organizational levels, but the focus is on the interaction between SECDEF and CCDRs, which ultimately helps the POTUS and SECDEF decide when, where, and how to commit US military forces.

## Unified Action in Execution

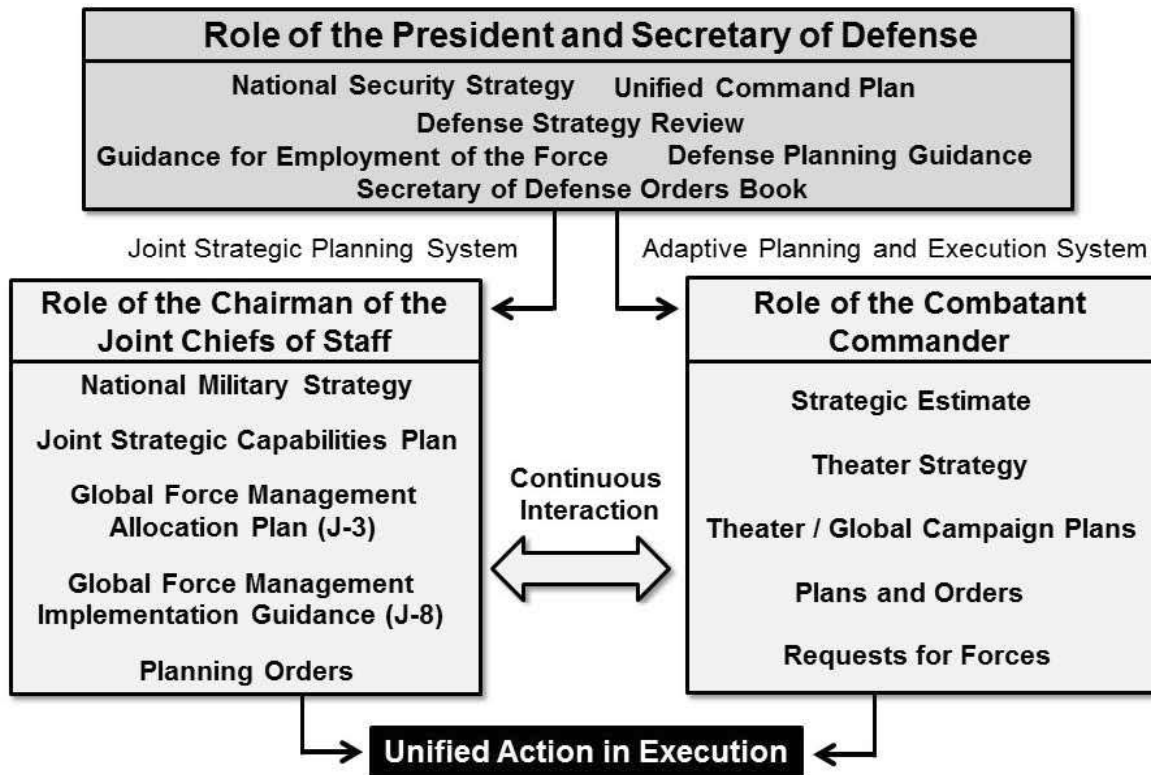

Derived from JP 5-0

**Figure 2-3. Unified Action in Execution**

b. The JPEC uses the APEX system to monitor, plan, and execute mobilization, deployment, employment, sustainment, redeployment, and demobilization activities associated with joint operations. The APEX enterprise operates in a networked, collaborative environment, which facilitates dialogue among senior leaders, concurrent and parallel plan development, and collaboration across multiple planning levels.

### 2-29. Joint Planning Process

In accordance with JP 5-0, Joint Planning—

a. The JFC and staff develop plans and orders through the application of operational art and operational design in conjunction with Joint Planning Process. Through the use of operational design and the application of operational art, commanders develop innovative, adaptive alternatives to solve complex challenges. The application of operational art and operational design further reduces uncertainty and adequately orders complex problems to allow for more detailed planning.

b. The planning staff typically uses JPP to conduct detailed planning to fully develop options, identify resources, and identify and mitigate risk. Planners develop the concept of operations (CONOPS), force plans, deployment plans, and supporting plans that contain multiple courses of action in order to provide the flexibility to adapt to changing conditions and remain consistent with the JFC's intent and present acceptable options to civilian decision makers.

c. JPP is an orderly, analytical set of logical steps to frame a problem; examine a mission; develop, analyze, and compare alternative courses of action (COAs); select the best COA; and produce a plan or order. JPP provides a proven process to organize the work of the commander, staff, subordinate commanders, and other partners, to develop plans that will appropriately address the problem. It focuses

on defining the military mission and development and synchronization of detailed plans to accomplish that mission.

## Joint Planning and Execution Community

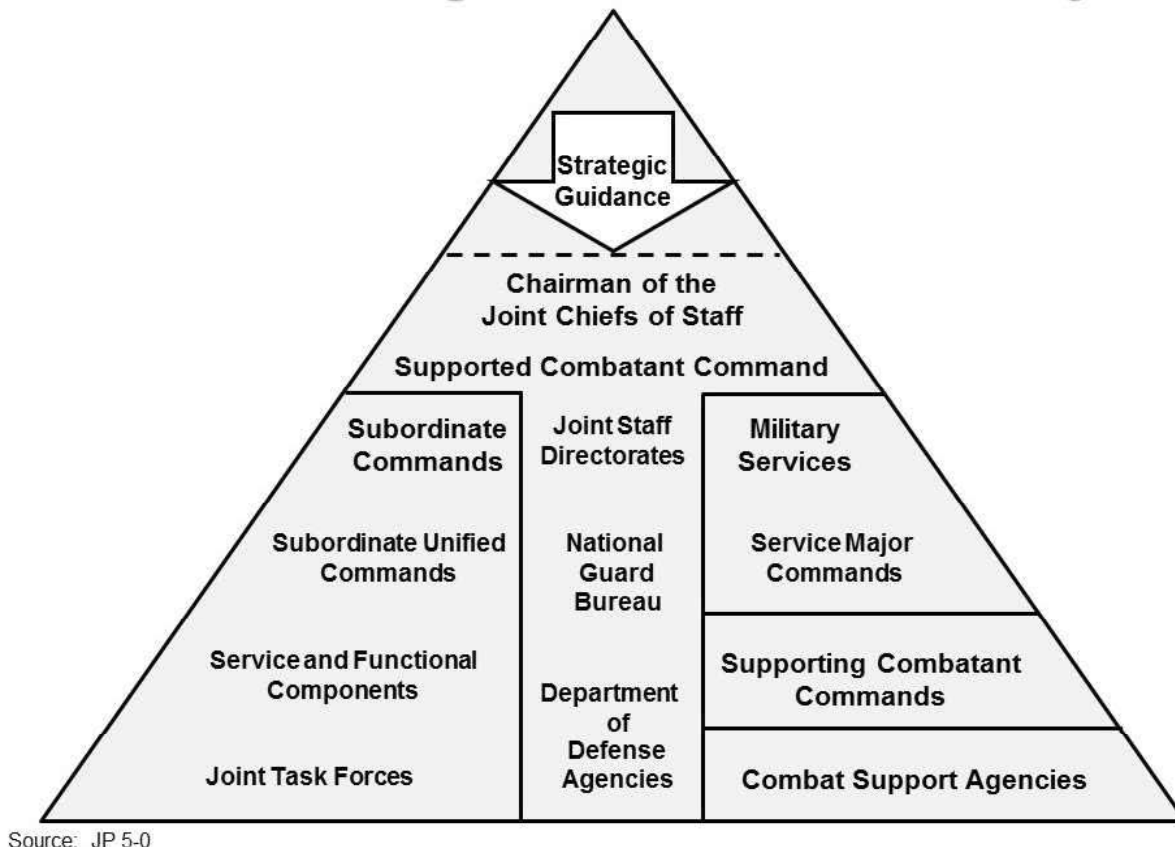

Source: JP 5-0

Figure 2-4. Joint Planning and Execution Community

### 2-30. Joint Planning Operational Activities

In accordance with JP 5-0, Joint Planning, Joint planning encompasses a number of elements, including three broad operational activities, as follows (see Fig 2-5)—

- a. Situational awareness addresses procedures for describing the operational environment, including threats to national security. This occurs during continuous monitoring of the national and international political and military situations so that CCDRs, JFCs, and their staffs can determine and analyze emerging crises, notify decision makers, and determine the specific nature of the threat.
- b. Planning translates strategic guidance and direction into campaign plans, contingency plans, and operation orders (OPORDs). Joint planning may be based on defined tasks identified in the GEF and the JSCP. Alternatively, joint planning may be based on the need for a military response to an unforeseen current event, emergency, or time-sensitive crisis.
- c. Execution begins when the President or SECDEF authorizes the initiative of a military operation or other activity. An execute order (EXORD), or other authorizing directive, is issued by the CJCS at the direction of the President or SECDEF to initiate or conduct military operations. Depending upon time constraints, an EXORD may be the only order a CCDR or subordinate commander receives. The EXORD defines the time to initiate operations and conveys guidance not provided earlier.

### 2-31. Joint Planning Functions

In accordance with JP 5-0, Joint Planning, Joint planning encompasses a number of elements, including four planning functions (see Fig 2-5). The four planning functions of strategic guidance, concept

development, plan development, and plan assessment are generally sequential, they often run simultaneously in order to deepen the dialogue between civilian and military leaders and accelerate the overall planning process.

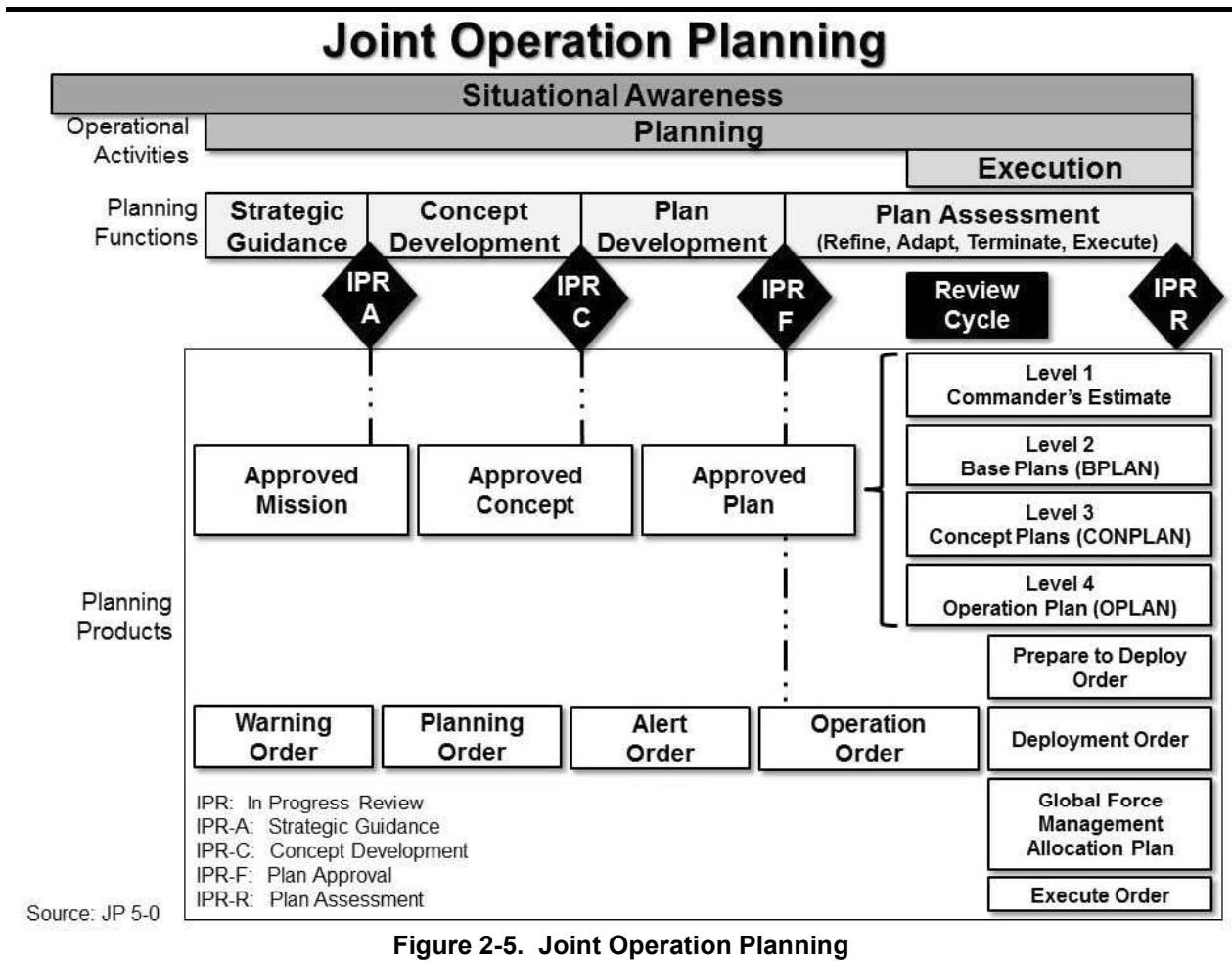

**Figure 2-5. Joint Operation Planning**

- a. *Strategic Guidance.* Strategic guidance initiates planning, provides the basis for mission analysis, and enables the JPEC to develop a shared understanding of the issues, OE, objectives, and responsibilities..
- b. *Concept Development.* During planning, the commander develops several COAs, each containing an initial CONOPS that should identify major capabilities and authorities required and task organization, major operational tasks to be accomplished by components, a concept of employment and sustainment, and assessment of risk. Each COA may contain embedded multiple alternatives to accomplish designated objectives as conditions change (e.g., operational environment, problem, strategic direction).
- c. *Plan Development.* This function is used to develop a feasible plan or order that is ready to transition into execution. This function fully integrates mobilization, deployment, employment, sustainment, conflict termination, redeployment, and demobilization activities through all phases of the plan. When the CCDR believes the plan is sufficiently developed to become a plan of record, the CCDR briefs the final plan to the SECDEF or a designated representative for approval.
- d. *Plan Assessment (Refine, Adapt, Terminate, Execute).* Commanders continually review and evaluate the plan; determine one of four possible outcomes: refine, adapt, terminate, or execute and then act accordingly.

## 2-32. Joint Planning Products

In accordance with JP 5-0, Joint Planning, joint planning encompasses the preparation of a number of planning and execution-related products. While the planning process is the same for CCMD campaign, contingency, or crisis planning, the output or products may differ. Contingency and CCMD campaign planning encompasses the preparation of plans that occur in non-crisis situations with a timeline generally not driven by external events. It is used to develop plans for a broad range of activities based on requirements identified in the GEF, JSCP, or other planning directives.

a. Campaign Plans. CCMD campaign plans are the centerpiece of DOD's planning construct. They provide the means to translate strategic guidance into CCMD strategies and subsequently into executable activities. CCMD campaign plans provide the vehicle for linking current operations to contingency plans.

b. Contingency Plans. Contingency plans are branches of campaign plans that are planned for potential threats, catastrophic events, and contingent missions without a crisis at-hand, pursuant to the strategic guidance of the UCP, GEF, and JSCP, and of the CCDR. There are four levels of planning detail for contingency plans, with an associated planning product for each level (see Fig 2-5).

(1) Level 1 Planning Detail—Commander's Estimate. This level of planning involves the least amount of detail and focuses on producing multiple COAs to address a contingency. The product for this level can be a COA briefing, command directive, commander's estimate, or a memorandum with a required force list.

(2) Level 2 Planning Detail—Base Plan (BPLAN). A BPLAN describes the CONOPS, major forces, concepts of support, and anticipated timelines for completing the mission. It normally does not include annexes.

(3) Level 3 Planning Detail—Concept Plan (CONPLAN). A CONPLAN is an OPLAN in an abbreviated format that may require considerable expansion or alteration to convert it into a complete and detailed Level 4 OPLAN or an OPORD.

(4) Level 4 Planning Detail—OPLAN. An OPLAN is a complete and detailed plan containing a full description of the CONOPS, all applicable annexes to the plan including a time-phased force and deployment list (TPFDL), and a transportation-feasible notional TPFDD. The OPLAN identifies the force requirements, functional support, and resources required to execute the plan and provide closure estimates for their flow into the theater.

c. Cross-AOR Planning. When the scope of contemplated military operations exceeds the authority or capabilities of a single CCDR to plan and execute, the President, SECDEF, or the CJCS, when designated by the President or SECDEF, identify a CCDR to lead the planning for the designated strategic challenge or threat.

d. Supporting Plans. Supporting CCDRs, subordinate JFCs, component commanders, and CSAs prepare supporting plans as tasked by the JSCP or other planning guidance. Commanders and staffs prepare supporting plans in CONPLAN/OPLAN format that follow the supported commander's concept and describe how the supporting commanders intend to achieve their assigned objectives and/or tasks. Supporting commanders and staffs develop these plans in collaboration with the supported commander's planners.

## Section VII

### Army-Level Strategy

## 2-33. Army Leaders

a. *Secretary of the Army*. In accordance with Title 10, USC, Subtitle B—Army, Part 1—Organization, Chapter 303—Department of the Army, Section §3013, Secretary of the Army, the Secretary is the head of the Department of the Army (DA) and responsible for, and has the authority necessary to conduct, all affairs of the DA, including the following functions: recruiting; organizing; supplying; equipping (including research and development); training; servicing; mobilizing; demobilizing; administering (including the morale and welfare of personnel); maintaining; the construction, outfitting, and repair of military equipment; and the construction, maintenance, and repair of buildings, structures, and utilities and the acquisition of real property and interests in real property necessary to carry out the responsibilities specified in this section. Subject to the authority, direction, and control of the SECDEF, the Secretary of the Army is also responsible to the SECDEF for: the functioning and efficiency of the DA; the formulation of policies and programs by the DA that are fully consistent with national security objectives and policies



established by POTUS or the SECDEF; the effective and timely implementation of policy, program, and budget decisions and instructions of POTUS or the SECDEF relating to the functions of the DA; carrying out the functions of the DA so as to fulfill the current and future operational requirements of the unified and specified combatant commands; effective cooperation and coordination between the DA and the other military departments and agencies of DOD to provide for more effective, efficient, and economical administration and to eliminate duplication; the presentation and justification of the positions of the DA on the plans, programs, and policies of DOD; and the effective supervision and control of the intelligence activities of the DA.

b. *Chief of Staff of the Army.* In accordance with Title 10, USC, Subtitle B—Army, Part 1—Organization, Chapter 305—The Army Staff, Section §3033, Chief of Staff, the Chief of Staff performs his duties under the authority, direction, and control of the Secretary of the Army and is directly responsible to the Secretary. Subject to the authority, direction, and control of the SecArmy, the CSA shall: preside over the Army Staff (ARSTAF); transmit the plans and recommendations of the ARSTAF to the SecArmy and advise the Secretary with regard to such plans and recommendations; after approval of the plans or recommendations of the ARSTAF by the Secretary, act as the agent of the Secretary in carrying them into effect; exercise supervision, consistent with the authority assigned to commanders of unified or specified combatant commands, over such of the members and organizations of the Army as the Secretary determines, perform duties as prescribed as a member of the Armed Forces Policy Council; and also perform the duties prescribed for him as a member of the Joint Chiefs of Staff (JCS). To the extent that such action does not impair the independence of the CSA in the performance of his duties as a member of the JCS, the CSA shall inform the SecArmy regarding military advice rendered by members of the JCS on matters affecting the DA. Subject to the authority, direction, and control of the SECDEF, the CSA shall keep the SecArmy fully informed of significant military operations affecting the duties and responsibilities of the Secretary.

## 2-34. The Army Plan

On 16 October 2014, the SecArmy and CSA published a memorandum entitled “Revisions to The Army Plan.” The purpose of the revisions were to: ensure that the Army vision and strategy are well-aligned with Army plans and resources; better enable Army leaders to provide clear guidance, strategic focus, and programming priorities to the Army; and expand TAP to compose five separate documents that each successively build upon the other while simultaneously serving to guide the Army’s strategy and budget development. In accordance with this memorandum the five documents include—

a. *Army Vision.* The purpose of the Army Vision (AV), section I of TAP, is to capture the unified direction of the SecArmy and CSA and articulate the Army’s “ends” in support of guidance from the National Command Authority (NCA).

(1) The AV articulates the desired end state of the SecArmy and CSA over a 10-year time horizon; at once, both challenging the Army and providing a “touchstone” to drive future change. It is the source document to which all other sections of the revised TAP are tethered, and serves as the central document from which all other strategic communication documents (e.g., the Army Posture Statement) emanate. Although the AV informs the initial strategic choices that the Army Strategic Plan (ASP) outlines, the AV is primarily intended for external audiences (Office of the SECDEF (OSD); Congress; the White House; think tanks; etc.).

(2) The AV’s principal authors will be the personal staffs of the SecArmy and CSA, with assistance from the immediate staffs of the Under Secretary of the Army and Vice Chief of Staff, Army (VCSA), as appropriate. The Deputy Chief of Staff (DCS), G-3/5/7, provides additional support, as required.

(3) At a minimum, the AV should be reviewed or published every four years, in close proximity to the release of a new National Defense Strategy. Although the AV is intended to endure over multiple Program Objective Memorandum (POM) cycles, some factors may necessitate more frequent changes or updates (e.g., radical shifts in the operational or fiscal environment; significant updates to the NCA guidance; significant changes to senior leader thinking, etc.).

b. *Army Strategic Plan.* The purpose of the ASP, section II of TAP, is to articulate a strategy that directs how the Army will fulfill its Title 10 responsibilities and additional statutory requirements over a 10-year time horizon. Its primary inputs are relevant NCA guidance (e.g., DSG; NSS; etc.) and the AV.

(1) Building on the AV and other senior leader guidance, the ASP re-emphasizes the Army’s “ends” and defines and describes the strategic goals and objectives of senior leaders. Additionally, the ASP provides a strategic assessment of the operating environment, explicitly articulates key assumptions in its strategy

formulation, and identifies key areas of risk. The ASP serves as the unifying document for all other Army strategic documents and plans (e.g., Army Modernization Strategy; Army Facility Strategy; etc.). Strategic guidance from the ASP directs planning and programming across multiple Future Years Defense Programs (FYDP), including Total Army Analysis (TAA), and guides changes to Doctrine, Organization, Training, Materiel, Leadership and Education, Personnel, Facilities, and Policy (DOTMLPF-P). The ASP serves as the key linkage between strategy and budget and informs the Army's annual planning efforts as part of the Planning, Programming, Budgeting, and Execution (PPBE) process. Despite its budget and programming implications, the ASP is a strategic document not directly linked to any single POM or fiscal year.

(2) The DCS, G-3/5/7 serves as the proponent for the ASP, and coordinates with relevant HQDA Principal Officials, ACOMs, ASCCs, and DRUs at appropriate times throughout ASP development.

(3) The ASP is published not later than 120 days following the release of each NDS. Additionally, the ASP is reviewed every two years and republished when senior leaders determine an update is required.

c. *Army Planning Guidance*. The purpose of the Army Planning Guidance (APG), section III of TAP, is to initiate the Army's annual PPBE process by identifying and providing guidance for key planning issues that require resolution or additional guidance before the POM build is complete. These planning issues may be identified from the previous year's POM, throughout program review, or as a result of decisions from other external actors (e.g., Congress; OSD; the White House; etc.).

(1) The APG will address near-, mid-, and far-term planning issues that apply to a specific budget year, later in the FYDP, or endure throughout it. The APG identifies each issue, provides a detailed description and applicable senior leader guidance, and identifies a responsible body for adjudication of that issue (e.g., the Army Management Action Group (AMAG); Planning Program Budget Committee (PPBC); Army Requirements Oversight Council (AROC); etc.). Additionally, the APG provides descriptive or prescriptive prioritization guidance addressing the hierarchy of functions for program development and budget execution. This prioritization guidance provides the ACOMs, DRUs, and Program Evaluation Groups (PEG) with initial senior leader guidance that remains applicable throughout the PPBE process, unless superseded by new guidance from the SecArmy and/or CSA. Finally, the APG designates those areas that the SecArmy and CSA have determined require centralized performance assessment management by the Army Campaign Plan.

(2) The DCS, G-3/5/7, serves as the proponent for the APG, and coordinates with the other co-chairs of the PPBC and members of the PPBC throughout the staff process.

(3) The APG is published not later than July 4<sup>th</sup> each year. Further updates and fragmentary orders (FRAGO) to the APG may be published as refinement requires.

d. *Army Program Guidance Memorandum*. The purpose of the Army Program Guidance Memorandum (APGM), section IV of TAP, is to codify decisions made throughout the planning process in order to resolve each of the issues identified in the APG.

(1) The APGM signals the end of the Army's planning phase and beginning of the Army's programming phase for the annual PPBE process, and provides specific programming guidance that informs the POM build.

(2) The Director, PA&E (DCS, G-8) serves as the proponent of the APGM, and coordinates with the other co-chairs of the PPBC and other members of the PPBC throughout the staff process.

(3) The APG is published following the POM Off-site, but not later than mid-January, each year. Specific technical guidance will be published during the PPBE process, as required.

e. *Army Campaign Plan*. The purpose of the Army Campaign Plan (ACP), section V of TAP, is to establish and monitor annual priorities and initiatives from the SecArmy and CSA that require measurable end states or decision in the year of execution. Army Campaign Plan for Fiscal Year 2017 (ACP17) represents the current evolution of the ACP and supersedes ACP 14.

(1) The development of ACP17 is a collaborative effort across the Total Army. ACP17 derives from strategic documents within The Army Plan along with published priorities of the Secretary of the Army and Chief of Staff of the Army. ACP17 reinvigorates Section V of The Army Plan as a powerful tool for driving transformational change within the Army. It consolidates several key decision-making activities into a single holistic process to drive Army Senior Leader decisions. ACP17 supports three essential purposes: drive Army Senior Leader decisions informed by risk; designate and integrate key Strategic Efforts that move the Army toward accomplishment of Army Senior Leaders' priorities; and assess the Army's performance in execution of Army Senior Leaders' priorities: Readiness, Future Army, and Care of Troops.

(2) The DCS, G-3/5/7, serves as the proponent of the ACP. ACP17 applies to Headquarters, Department of the Army (HQDA), Army commands, Army Service Component Commands, Direct Reporting Units, supporting agencies, and activities.

(3) The DCS, G-3/5/7 reviews this plan quarterly and updates it annually or as needed to ensure viability and relevancy

## Section VIII

### Summary, Key Terms, and References

#### 2-35. Summary

There are several interrelated aspects within the strategy module of the Force Management Model – laws, leaders, processes, and documents – which influences how the Army runs. The laws, as designated in the U.S. Code and DOD, joint, and Army supporting documents to the U.S. Code, form the foundation of how strategic and operational requirements must be determined. The leaders at each echelon—national, defense, joint, and Army—then base their visions and develop their assessments, advice, and direction based on how they want the strategic and operational requirements met. With every module impacted by strategy simultaneously and continuously, the processes at each echelon and further across the Army Force Management Model then result in a structure within which resources can be applied to in order to produce trained and ready units for CCDRs. Finally, the documents, when published in accordance with legal timelines and when nested appropriately, assist leaders, force managers, CCDRs, and Soldiers to execute the strategy to defend the nation.

#### 2-36. Key Terms

The key terms were taken from Joint Pub 1-02, DOD Dictionary of Military and Associated Terms, August 2017.

a. *Adaptive Planning and Execution* A Department of Defense enterprise of joint policies, processes, procedures, and reporting structures, supported by communications and information technology, that is used by the joint planning and execution community to monitor, plan, and execute mobilization, deployment, employment, sustainment, redeployment, and demobilization activities associated with joint operations. Also called APEX. (JP 5-0)

b. *Allocation*. Distribution of limited forces and resources for employment among competing requirements.

c. *Apportionment*. The quantities of force capabilities and resources provided for planning purposes only, but not necessarily an identification of the actual force that may be allocated for use when a plan transitions to execution.

d. *Combatant Command*. A unified or specified command with a broad continuing mission under a single commander established and so designated by the President, through the Secretary of Defense and with the advice and assistance of the Chairman of the Joint Chiefs of Staff.

e. *Combatant Commander*. A commander of one of the unified or specified combatant commands established by the President. Also called CCDR.

f. *Department of the Army*. The executive part of the Department of the Army at the seat of government and all field headquarters, forces, Reserve Component, installations, activities, and functions under the control or supervision of the Secretary of the Army. Also called DA.

g. *Deployment Order*. A directive from the Secretary of Defense, issued by the Chairman of the Joint Chiefs of Staff, that authorizes the transfer of forces between combatant commands, Services and Department of Defense agencies and specifies the authorities the gaining combatant commander will exercise over the specific forces to be transferred. Also called DEPORD.

h. *Instruments of National Power*. All of the means available to the government in its pursuit of national objectives. They are expressed as diplomatic, economic, informational, and military.

i. *Joint*. Connotes activities, operations, organizations, etc., in which elements of two or more Military Departments participate.

j. *Joint Planning*. Planning activities associated with military operations by combatant commanders and their subordinate commanders.

k. *Joint Operations*. Military actions conducted by joint forces and those Service forces employed in specified command relationships with each other, which of themselves, do not establish joint forces.

l. *Joint Staff*. 1. The staff of a commander of a unified or specified command, subordinate unified command, joint task force, or subordinate functional component (when a functional component command will employ forces from more than one Military Department), that includes members from the several Services comprising the force. 2. (capitalized as Joint Staff) The staff under the Chairman of the Joint Chiefs of Staff that assists the Chairman and the other members of the Joint Chiefs of Staff in carrying out their responsibilities. Also called JS.

m. *Joint Strategic Planning System*. One of the primary means by which the Chairman of the Joint Chiefs of Staff, in consultation with the other members of the Joint Chiefs of Staff and the combatant commanders, carries out the statutory responsibilities to assist the President and Secretary of Defense in providing strategic direction to the Armed Forces. Also called JSPS.

n. *Joint Task Force*. A joint force that is constituted and so designated by the Secretary of Defense, a combatant commander, a subunified commander, or an existing joint task force commander. Also called JTF.

o. *Military Department*. One of the departments within the Department of Defense created by the National Security Act of 1947, which are the Department of the Army, the Department of the Navy, and the Department of the Air Force. Also called MILDEP.

p. *National Military Strategy*. A document approved by the Chairman of the Joint Chiefs of Staff for distributing and applying military power to attain national security strategy and national defense strategy objectives. Also called NMS.

q. *National Security Council*. A governmental body specifically designed to assist the President in integrating all spheres of national security policy. Also called NSC.

r. *National Security Strategy*. A document approved by the President of the United States for developing, applying, and coordinating the instruments of national power to achieve objectives that contribute to national security. Also called NSS.

s. *Strategic Direction*. The strategy and intent of the President, Secretary of Defense, and Chairman of the Joint Chiefs of Staff in pursuit of national interests.

t. *Strategy*. A prudent idea or set of ideas for employing the instruments of national power in a synchronized and integrated fashion to achieve theater, national, and/or multinational objectives.

u. *Unified Command*. A command with a broad continuing mission under a single commander and composed of significant assigned components of two or more Military Departments that is established and so designated by the President, through the Secretary of Defense with the advice and assistance of the Chairman of the Joint Chiefs of Staff. Also called unified combatant command.

v. *Unified Command Plan*. The document, approved by the President, that sets forth basic guidance to all unified combatant commanders; establishes their missions, responsibilities, and force structure; delineates the general geographical area of responsibility for geographic combatant commanders; and specifies functional responsibilities for functional combatant commanders.

## 2-37. References

- a. CJCS Instruction 3100.01C, Joint Strategic Planning System, Nov 2015.
- b. Combatant Command websites, accessed October 2017—
  - (1) <http://www.africom.mil>.
  - (2) <http://www.centcom.mil>.
  - (3) <http://www.eucom.mil>.
  - (4) <http://www.northcom.mil>.
  - (5) <http://www.pacom.mil>.
  - (6) <http://www.socom.mil>.
  - (7) <http://www.southcom.mil>.
  - (8) <http://www.stratcom.mil>.
  - (9) <http://www.transcom.mil>.
- d. Global Force Management Implementation Guidance, 2015-2016.
- e. Interview with Blackburn, James R., Brigadier General, 3rd Infantry Division, 16 Mar 2015.
- f. Joint Pub 1-02, Department of Defense Dictionary of Military and Associated Terms, August 2017.
- g. Joint Publication 1-0, Doctrine for the Armed Forces of the United States, 25 Mar 2013.
- h. Joint Publication 3-0, Joint Operations, 17 Jan 2017.
- i. Joint Publication 5-0, Joint Planning, 16 June 2017.
- j. Memorandum: Revisions to The Army Plan, 16 Oct 2014.

- k. National Security Strategy, Dec 2017.
- l. The Army Vision, 11 May 2015.
- m. Title 10, United States Code @ <http://uscode.house.gov>.

**This page is intentionally left blank**

## Chapter 3

### Force Management

#### Section I Introduction

#### 3-1. Chapter Content

a. This chapter provides a holistic overview of the interconnected systems and processes used to develop and manage change in the Army. It reflects the fact, as General George C. Marshall understood, that, in complex organizations, every action or problem affects every other function of the organization. Army force management systems and processes dictate the entire life cycle of the Army from the earliest stages of conceptual development to the final disposition of people, equipment, and facilities.

b. This chapter discusses force management, the Army force management model, the Army Organizational Life Cycle Model (AOLCM), force development, and force integration.

#### 3-2. Force Management Overview

a. In his Biennial Report of the Chief of Staff of the United States Army to the Secretary of War for the period July 1, 1939, to June 30, 1941, General George C. Marshall described the stark situation in which he found the Army as the war in Europe erupted and threatened to involve a neutral United States. President Roosevelt's emergency proclamation of September 8, 1939 had given the authority for the Active Army to expand from 210,000 to 227,000 men and to reorganize from the World War I square divisions to the new triangular divisions. However, General Marshall's problems could not be solved by a manpower increase of less than 10% and division reorganization. He also had major training deficiencies to correct. There was such a shortage in motor transportation that divisional training was impracticable. A lack of corps headquarters and experienced commanders and obsolete doctrine and organizational designs further degraded capabilities. Over half the undermanned Active Army divisions were horse-mounted and the horse was still the primary means of mounted movement. At the same time Congress had reduced the Army Air Corps request for replacements to World War I aircraft to only 57 planes. It was even worse in the National Guard organizations. General Marshall's solution to these massive problems was to reconstruct the Army by resourcing, structuring, and integrating new equipment, personnel, and organizations while training. He also improved the youth and vitality of the Army by discharging elderly and substandard Soldiers. The U.S. Army's success in creating, deploying, and sustaining 89 divisions for the European Theater during World War II was largely due to General Marshall's genius and his skill at what, today, is known as force management.

b. Managing change in any large, complex organization requires management of many interrelated processes. In the context of developing operational organizations with highly trained personnel, led by confident leaders, using technologically advanced equipment, and providing that capability when needed by the combatant commander (CCDR), the Army manages from an organizational life cycle view.

#### 3-3. Force Management Model

a. To aid in examining specific force management systems and their interactions, the U.S. Army War College has adopted the Army Force Management Model shown in Figure 3-1 (see the fold-out at the end of this book). The Army Force Management Model is a "system of systems" approach to generating trained and ready units for combatant commander (CCDR) employment. The Army Force Management Model is a roadmap divided into seven distinct modules, as follows:

(1) Determine strategic and operational requirements. The strategy module includes national-, defense-, joint-, and Army laws, leaders, documents, and processes, including global force management (GFM) demands.

(2) Develop required capabilities / doctrine, organization, training, materiel, leadership and education, personnel, facilities, and policy (DOTMLPF-P) solutions. This module includes the joint capabilities integration and development system (JCIDS).

(3) Design organizations, develop organizational models, and document organizational authorizations all combine to make-up the structure module.

(4) Acquire Materiel Solutions. The Defense Acquisition System (DAS) is at the heart of this module.

(5) Determine Authorizations. This module includes total Army analysis (TAA) and planning, programming, budgeting and execution (PPBE).

(6) Acquire, Train, and Distribute Personnel.

(7) Acquire and Distribute Equipment.

c. The force management model shows the relationships of Army processes to each other, and to the major Department of Defense (DOD) management processes. The underlying basis for this model is that force management, in its simplest context, is the management of change using many interrelated and complex processes. Although the model depicts the flow of processes in a somewhat linear, sequential manner, the complexities of managing change mandate that at any one time an initiative may be simultaneously in several of these processes at some level of maturity. As organizations develop, these processes may run sequentially, be compressed, run in parallel, or even run in reverse depending on the urgency, risk, and senior leader guidance on the issue. History has shown, however, that eventually all of the steps must take place to produce a fully trained and equipped operational force at the right time and at the right place to support the CCDR.

d. In this model, strategic and senior leadership guidance, the processes for determining warfighting capabilities requirements, conducting research and development (R&D), and providing resources all provide input to the force development process. The resulting products of force development, in turn, provide the basis for the force integrating functions of acquiring and distributing materiel, as well as acquiring, training, and distributing personnel. This widely used model highlights key aspects and relationships of force management.

### 3-4. Force Management Tools

There are a number of interrelated databases and systems used by the force management community to manage change across the Army.

a. *Structure and Manpower Allocation System (SAMAS).*

(1) SAMAS is the Army's automated force structure authoritative data source (i.e. database of record) for force accounting and manpower and unit programming. DCS, G-3/5/7 FM (DAMO-FMP) is the proponent for SAMAS.

(2) All approved units from TAA are entered into SAMAS to create the POM Force. The primary inputs to SAMAS are the Operating Forces (OFs) directed by the Army leadership, such as brigade combat teams, divisions, corps, ASCCs, armored cavalry regiments, Special Forces groups, and the forces required to support the combat structure. Generating Forces (GF) are allocated during TAA and organizational structure is refined during the command plan processes or as updated by a TDA change management plan (CMP) or concept plan.

(3) SAMAS contains the programmatic and force structure data used for the creation and approval of authorization documents.

(4) SAMAS retrievals permit detailed and summary analysis of the Army force structure to include organization, unit description, and strength data. Outputs are used across the Army staff to build detailed personnel, equipping, sustainment, installation, and training program data.

(5) The SAMAS database does not contain detailed personnel data or equipment information. It does include more than 100 categories of unit information that can be extracted selectively for analysis. Key elements of information, in addition to required and authorized strengths by identity, are the Unit Identification Code (UIC), Effective Date (EDATE), location, assignment code, Army management structure code (AMSCO), troop program sequence number (TPSN), and standard requirements code (SRC).

(6) SAMAS has both classified and unclassified data and applications.

(7) SAMAS has two primary outputs—

(a) The force structure file (commonly referred to as the "force file"), reflects the approved (programmed and documented) force structure position for each unit in the Army. The force file produces the Army's Master Force (MFORCE), which is the complete database of the entire Army's force structure. The



MFORCE reflects the CSA-approved current, budgeted, and programmed force structure of the Army. It is the authoritative record of the total force over time. Throughout the year, periodic force review points will adjust the MFORCE to reflect Senior Leaders Department of the Army (SLDA) decisions.

(b) Program and budget guidance (PBG) file (commonly referred to as the “budget file”). The budget file produces the manpower addendum to the PBG. Primary inputs to the budget file come from the annual command plan submissions of the Army commands, TDA change management plan, PBD, budget change proposals, program change proposals, and POM decisions.

(8) SAMAS conducts the three way synchronization among the force file, budget file and authorization documents. This is commonly referred to as Automated Update Transaction System. (AUTS). This process ensures authorization documents are matched to the planned structure and strengths programmed in SAMAS. A match will result in approval to publish and release an authorization document.

(9) SAMAS lock-point data is available through DCS, G-3/5/7 (DAMO-FMP) with approved access.

b. *Army Force Management System (FMS)*.

(1) FMS is the information technology (IT) system for Basis of Issue Plan (BOIP), Table of Organization and Equipment (TOE), Modified Table of Organization and Equipment (MTOE), and Table of Distribution and Allowance (TDA) development. It is the database of record for UIC, paragraph- and line-level of detail for personnel and equipment. It aligns with the information in SAMAS.

(2) The United States Force Management Support Agency (USAFMSA) is the proponent for FMS. Access to FMS is limited to the force development community.

(3) Data contained in the Army's FMS will adhere to standards required by DODD 8320.03, and DODM 82600.03, Volumes 1 and 2.

(4) FMS has both classified and unclassified data and applications.

(5) FMS data is distributed through FMSWeb and the Army Organization Server (AOS).

c. *Army Force Management System Web (FMSWeb)*.

(1) FMSWeb is a website that provides access to FMS data: TOEs, MTOEs, BOIPs, TDAs, CTA, JTA, and associated reference data and tools. FMSWeb is the repository for approved and in-staffing requirements and authorization documents. AR 71-32 contains a detailed list of FMSWeb capabilities.

(2) USAFMSA is the proponent for FMSWeb and approves access to the website.

(3) Data from FMS may be viewed through the FMS Web site (FMSWeb), which is available at <https://fmsweb.fms.army.mil/>, provides retail level access to requirements and authorizations data and the Global Force Management Data Initiative (GFM-DI) digitally tagged hierarchical data.

d. *Army Organization Server (AOS)*.

(1) The AOS is a data distribution hub that provides wholesale-level computer-to-computer access to authoritative past, current, and future GFM DI formatted HQDA approved Army authorization data.

(2) USAFMSA is the designated proponent for the AOS.

(3) DODI 8260-03 - The Organizational and Force Structure Construct, February 19, 2014 -- and associated DODMs, DOD Instruction 8320.02 -- Sharing Data, Information, and Information Technology (IT) Services in the Department of Defense, August 5, 2013, and related documents require the OSD, Joint Staff, Intelligence Community, and Armed Services to operate and maintain classified and unclassified GFM DI organization servers.

e. *Global Force Management Data Initiative (GFM DI)*.

(1) The DOD has directed that all enduring automation systems consuming detailed force structure authorization data transition to the GFM DI format.

(2) The GFM DI is a Joint Staff and OSD initiative designed to standardize force structure representation, making it visible, accessible, and understandable across the DOD. Unique identifiers associate billets, crews, equipment, and chain of command links, enabling electronic manipulation across multiple systems. Through establishment of an information exchange data standard, GFM DI enables DOD systems to exchange force structure data in a common format while exploiting the net-centric data environment.

(3) The central principle of GFM DI is that force structure data is foundational for assessing and applying service capabilities in support of the National Military Strategy (NMS). GFM DI will facilitate the transformation of the processes used for global force management, readiness, command and control, manning, and logistics.

(4) USAFMSA is the designated proponent for GFM DI authorization data.

(5) Joint Staff J-8 Models and Analysis Support Division is the designated proponent for DOD implementation.

f. *Structure and Composition Database (SACDB)* (see Fig 3-2).

## Structure and Composition System

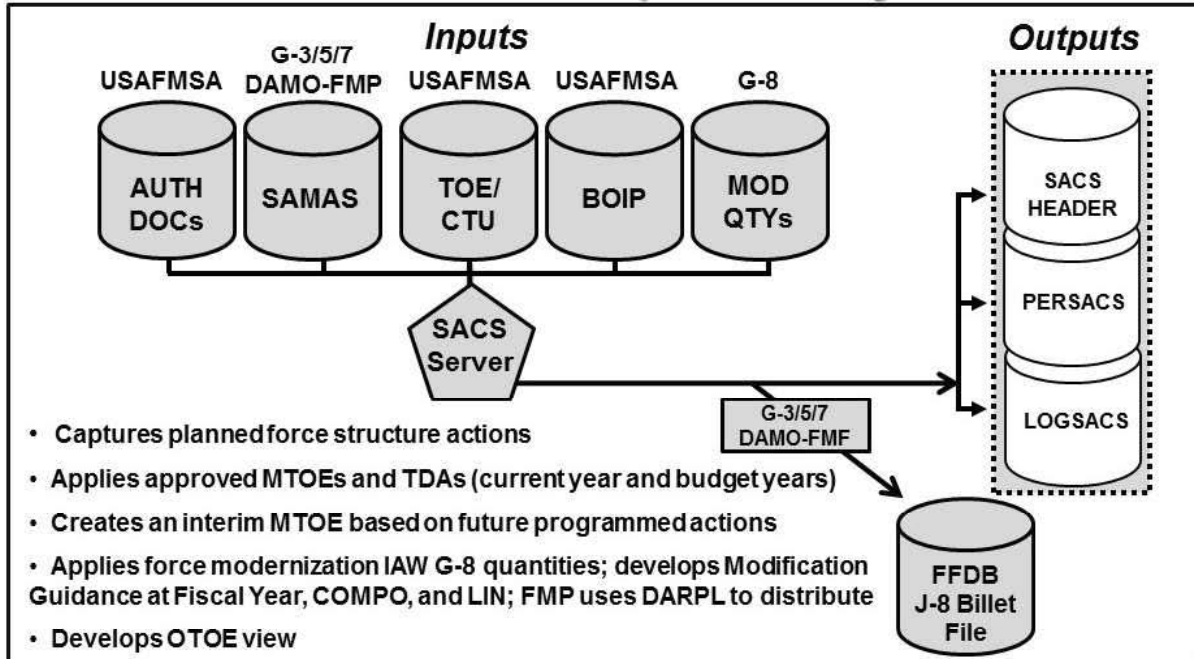

BOIP: Basis of Issue Plan

COMPO: Component

CTU: Consolidated TOE Update

DAMO-FMF: Force Integration and Management

DAMO-FMP: Force Accounting and Documentation

DARPL: Dynamic Army Resourcing Priority List

FFDB: Future Forces Database

LIN: Line Item Number

LOGSACS: Logistics Structure and Composition System

MTOE: Modified Table of Organization and Equipment

OTOE: Objective Table of Organization and Equipment

PERSACS: Personnel Structure and Composition System

SACS: Structure and Composition System

SAMAS: Structure and Manpower Allocation System

TDA: Table of Distribution and Allowance

USAFMSA: U.S. Army Force Management Support Agency

Figure 3-2. Structure and Composition System

(1) The SACDB report portrays the Army's time-phased demands for personnel and equipment over the current, budget and program years, and at OTOE levels. In this way, SACDB shows current levels of modernization, levels achieved at the end of the POM, and a fully modernized Army for planning purposes.

(2) The approved force lock (MFORCE or force review point (FRP)) is the key force structure input to initiate the SACDB cycle.

(3) SACDB combines and synchronizes information from BOIPs, TOEs, the SAMAS force file, MTOEs, and TDAs, within resource constraints.

(4) SACDB is operated and maintained by DAMO-FMP.

(5) SACDB is typically created after each force lock point, typically 2 to 3 times per year.

(6) SACDB reflects programmed force modernization changes using AE2S estimated LIN quantities by COMPO, by FY provided by DCS, G-8 (DAPR-FD) and prioritized using the Dynamic Army Resourcing Priority List (DARPL).

(7) SACDB provide personnel and equipment requirement data to help build the Army sourcing lay-down for global requirements. SACDB outputs include—

(a) *Personnel Structure and Composition (PERSAC)*. PERSAC combines data from the SAMAS and TOE systems to tabulate and project military personnel requirements and authorizations for each unit in the force for the 10 years of the SACDB. This data supports planning for personnel recruiting, training, promoting, validating requisitions, and distribution. PERSACDB, while a product of SACDB, is itself an

input to other processes. For instance, the Personnel Management Authorization Document (PMAD), used by DCS, G-1 and Army Human Resources Command, provides personnel requirements and authorizations. PERSACDB summarizes the time-phased requirements and authorizations for personnel at the UIC, EDATE, MOS, Grade, and quantity (QTY) level of detail for requirements and authorization for MTOE and TDA units. These are portrayed at summary, rather than paragraph and line level of detail.

(b) *Logistics Structure and Composition (LOGSAC)*. LOGSAC combines data from the SAMAS, TOE, BOIP, and EQUIPFOR (EQ4) to tabulate and project equipment requirements and authorizations for each unit in the force for the current, budget, and POM years extended for a total of 10 years. LOGSACDB, while a product of SACDB, is itself an input to other processes. For example, the Total Army Equipment Distribution Program (TAEDP) uses equipment requirements and authorizations from LOGSACDB to plan equipment distribution. LOGSACDB summarizes the time-phased requirements and authorizations for equipment at the UIC, EDATE, LIN, equipment readiness code (ERC), and quantity (QTY) level of detail for requirements and authorization for MTOE and TDA units.

(g) *Enterprise Management Decision Support System (EMDS)*. The EMDS system serves as the Army's common operating picture for integrated readiness, resourcing, deployment, and force generation analytics information. EMDS is a Secret Internet Protocol Router Network (SIPRNet) integrated, data-driven, commercial off-the-shelf (COTS) business intelligence system designed for the DA (military, government, and civilians). EMDS—

(1) Integrates authoritative data from multiple Army sources to provide visually driven analytic tools for personnel, equipment, training, deployment, and installations. EMDS analytic tools include customizable dashboards, table and chart views, and advanced discovery and search tools.

(2) Provides Army decision makers and their staff with the ability to conduct force planning in alignment with deployment schedules, readiness, and resourcing assessments.

(3) Provides this level of information for the Army's operating and generating forces (MTOE and TDA) units, FORSCOM's Derivative UICs (DUICs), and Assistant Chief of Staff for Installation Management's (ACSIM's) installation reports.

(4) Provides DCS, G-3/5/7's force generation, resourcing, and readiness common operating pictures for all COMPOs.

(5) DCS, G-3/5/7 FM (DAMO-FME) is the proponent for EMDS.

(6) The EMDS portal is located at <https://emds.army.smil.mil> on the SIPRNet.

(h) *Army Equipping Enterprise System (AE2S)*. AE2S is the Army's web-based and common access card enabled Knowledge Management and decision support system for equipment modernization. It contains the Army's programmed force for the equipping program evaluation group (EE PEG) POM development, projected inventories based on equipment procurements and allocations to each of the components for equipment distribution transparency and BOIP application analysis.

(1) DCS, G-8 is the proponent for AE2S.

(2) AE2S contains the enhanced Army Flow Model that produces the Total Army Equipment Distribution Plan (TAEDP). It contains other allocation and distribution models to provide courses of action for investments, allocations, and distributions of existing and new equipment. The system combines data from authoritative sources and calculates the Total Army Requirement for equipment within capability groups; supports affordability analysis; and contains the Army acquisition and procurement objective for new and modifications of existing equipment. AE2S is accessible at <https://afm.us.army>.

### 3-5. Army Organizational Life Cycle Model

a. The Army Organizational Life Cycle Model (AOLCM) graphically captures the continuous cycle of developing, employing, maintaining, and eliminating organizations. The Army force management approach recognizes the need to understand modernization and change as a complex adaptive system. AOLCM provides a conceptual framework to both analyze and assess Army change efforts.

b. The AOLCM shown at Figure 3-3 reflects the stages that organizations and their personnel and equipment will experience at one time or another (and often concurrently) during their service in the Army. The functions performed in these stages develop, field, sustain, and modernize operational units and their supporting organizations; maintain their viability and effectiveness; and remove them or their assets (personnel and materiel) from the force as requirements change. Each individual asset (a Soldier, a civilian, or materiel) required by a unit or activity will be managed at some stage of the model beginning with the establishment of the need and entry into the Army to ultimate separation or disposal. The model details the critical stages through which an organizational resource will move, at some point, during its life

span. Generally, the model depicts the life cycle of Army organizations from their development and their progression (clockwise around Figure 3-3) to separation. The dynamic of the model, displayed by the interconnecting lines, illustrates that the Army leadership must resource and manage all of the functions simultaneously, since Army assets will be in each functional stage at any one time. Any change to a resource in a functional stage will affect resources in most, if not all, of the other functional stages. In other words, if you influence or change something in one functional node the response will impact the entire model affecting other nodes to some degree.

## Army Organizational Life Cycle Model

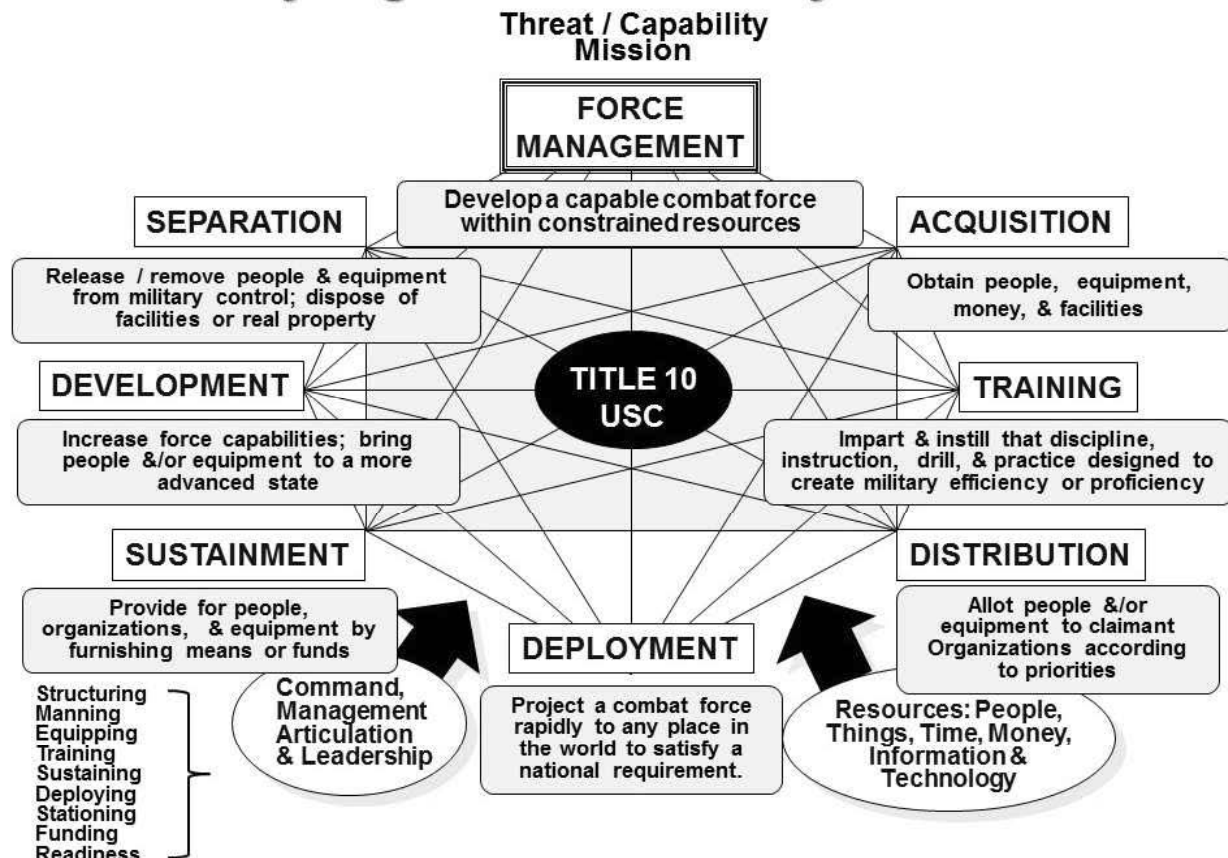

**Figure 3-3. Army Organizational Life Cycle Model**

c. Life cycle functions are listed below.

(1) *Force Management*. As the first phase of the organizational life cycle model, force management becomes the key activity underlying all other functions. The process involves decision-making, and execution of activities encompassing conceptual development, capabilities requirements generation, force development, organizational development, force integration functions, and resourcing. Force management results in the development of a capable operational force within constrained resources.

(2) *Acquisition*. After the Congress authorizes, and the Department of Defense (DOD) provides, the budget and the End Strength (ES) guidance, the Army must then acquire the people and materiel specified in the requirements and authorizations documents necessary to accomplish specified missions. From a materiel acquisition perspective, the acquisition function extends beyond the principal item being fielded and must consider other essential requirements such as the availability of Associated Support Items of Equipment and Personnel (ASIOEP), technical publications, repair parts, trained personnel, and facilities. From a human resource (HR) acquisition perspective, the acquisition function must consider recruiting and accession missions in concert with the overall manpower management program and the influences of personnel life cycle functions.

(3) *Training.* The training function encompasses the processes for accomplishing the transition from civilian status to military service. In this context, the training function is somewhat different from what most Army leaders think of when discussing training. At this point in the life cycle, consider training from the aspect of initial entry training or the requirement to provide Soldiers with initial new equipment training or familiarization training on new or displaced equipment. In other words, this aspect of the training cycle imparts new skills to the Soldier or converts the civilian into a Soldier. It most often results in award of a Military Occupational Specialty (MOS) or Additional Skill Identifier (ASI). The training function also includes the transition of U.S. Military Academy (USMA), Reserve Officers Training Corps (ROTC), and Officer Candidate School (OCS) graduates into officers through the Basic Officer Leaders Course (BOLC). Traditional collective training and professional educational and leader development fall under the "development" phase of the Organizational Life Cycle Model.

(4) *Distribution.* Having produced or procured the resources necessary to form and sustain units they must be distributed according to established requirements, authorizations, and priorities. The distribution function includes the assignment of people from entry-level training to their initial unit and the delivery of new materiel from the wholesale level to the user. This activity is primarily managed and synchronized through the Army force generation process that focuses equipment and personnel distribution during the Prepare module of the Sustainable Readiness Model (SRM).

(5) *Deployment.* Deployment represents both a planning and operational function involving agencies on the Army Staff (ARSTAF), other levels of DOD, and the civilian transportation structure. Like many of other AOLCM activities, unit deployments are managed on a cyclical basis with Army force generation cycles. Once trained or prepared units, individuals, packages, or materiel become available to support worldwide operations. An individual Soldier, civilian, unit, or item of equipment may be subject to some, if not all, of the mobilization, deployment, redeployment, demobilization, and reconfiguration processes of this function.

(6) *Sustainment.* In peace or war the presence of people and materiel in units establishes a requirement for sustainment. People, skills, capability, and equipment must be maintained to the standard set for mission accomplishment by replacement, rotation, repair, and training operations. From a personnel perspective this function covers Soldier reassignments throughout a career or obligation period, quality of life and well-being programs, as well as other aspects of the personnel systems influencing retention. Repair parts and maintenance provide the sustainment process for materiel. Training in units covering the process of sustaining common Soldier skills that maintain individual proficiency falls under this function as well. The manning priority level, the Dynamic Distribution System (DDS), Dynamic Army Resourcing Priority List (DARPL), Basis of Issue Plan (BOIP), 10 classes of supply, the Authorized Stockage Lists (ASL), and Prescribed Load Lists (PLL) illustrate some of the systems or techniques used to manage authorizations and priorities within the sustainment function..

(7) *Development.* The Army must constantly develop and improve. We develop individuals through civilian, enlisted, and officer education programs that include character and leader development activities. Education and training programs range from individual self-development, including graduate-level degree programs, to the entire range of branch- and skill-related institutional training culminating at either the senior service college for officers and civilians or Sergeants Major Academy for enlisted Soldiers. Units develop through collective training processes that include individual training in units, home station training, and deployments for training. Examples are Collective Training Tasks (CTT), leader training, live fire and maneuver training, external evaluations such as those under the Army Training and Evaluation Program (ARTEP), deployment exercises, and training rotations to the Combat Training Centers (CTC).

(8) *Separation.* Finally, people and equipment separate from military service. People may separate voluntarily by not extending following completion of an obligated service period or by retiring. Involuntary separation may occur due to Reduction in Force (RIF) actions or qualitative reasons. The Army normally separates materiel through the Defense Reutilization and Marketing Office (DRMO) process or through Foreign Military Sales (FMS) actions.

d. There are two categories of external influences that affect the model,—

(1) The first category is the availability of resources. Resources include tangible objects in the form of funds, materiel, or personnel as well as intangible resources such as time, information, and technology.

(2) The second category is the influence of command, management, and leadership in planning, organizing, directing, controlling, and monitoring the multitude of inputs, decisions, and actions to ensure that functions at each stage of the model execute effectively and at the appropriate time. These command and management activities are synchronized within the Army force generation process to

# HOW THE ARMY RUNS

ensure the timely allocation of scarce resources and to maximize the availability of trained and ready Army forces to meet Combatant Commanders (CCDR) Army force requirements.

## Section II Force Development

### 3-6. Force Development Overview

a. Force development (FD) is the first of three major sub-processes within Force Management. It is a process that defines military capabilities, designs force structures to provide these capabilities, and produces plans and programs which, when executed through force integration (the second major sub-process), translate organizational concepts based on doctrine, technologies, materiel, manpower requirements, and limited resources into a trained and ready Army (see Fig 3-4).

## Force Development Process

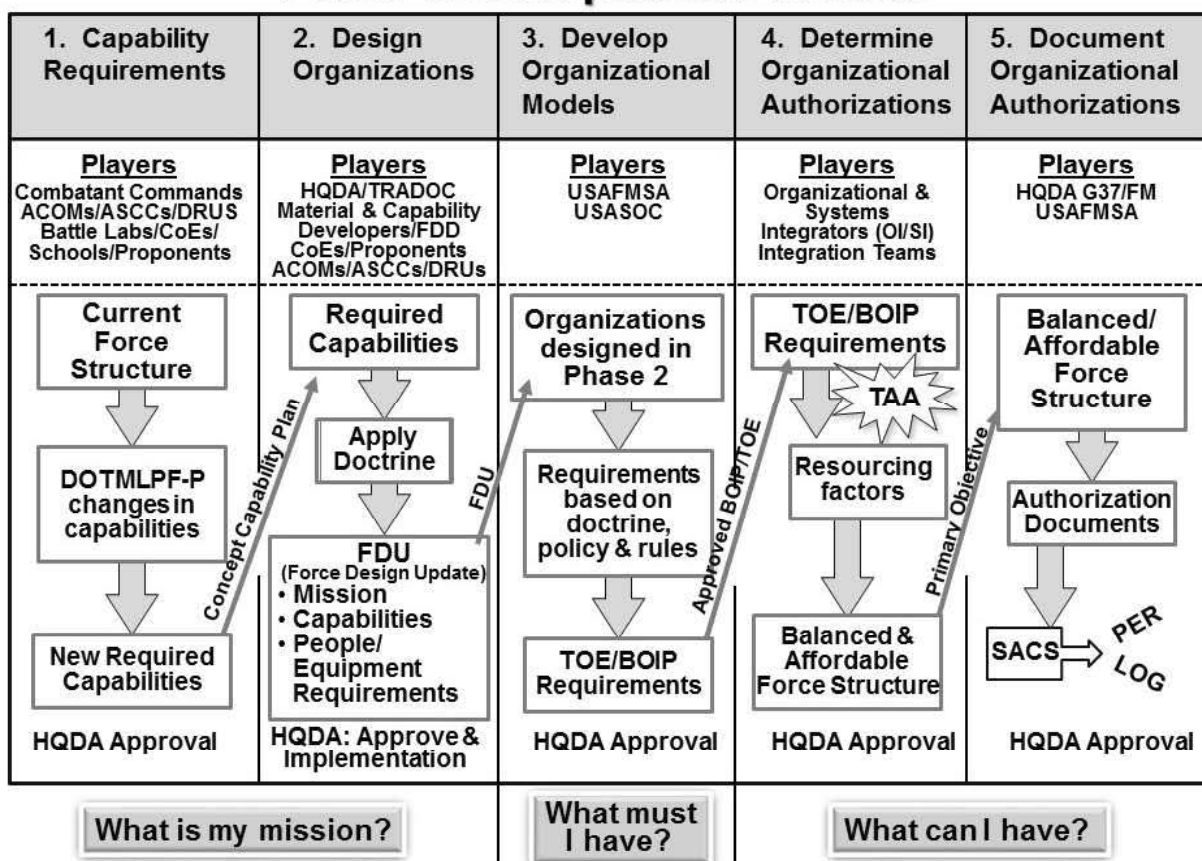

Figure 3-4. Force Development Process

- b. The five-phased FD process includes—
- (1) Determine capabilities requirements.
  - (2) Design organizations.
  - (3) Develop organizational models.
  - (4) Determine organizational authorizations.
  - (5) Document organizational authorizations.

c. Force development starts with the operational capabilities desired of the Army as specified in national-, defense-, joint-, and Army-level strategies (see Chap 2, Strategy), as well as the needs of the CCDR. Strategic guidance identifies the Range of Military Operations (ROMO) that the Nation's leaders

expect their military forces to perform, the effects they must achieve, the attributes those forces must possess, where they must operate, and generally what kind and what size of force is expected to execute those operations. Strategic guidance informs the development of the Contemporary Operational Environment (COE) and future Joint Operating Environment (JOE). These visualizations of the Operational Environment (OE) describe the composite of conditions, circumstances, and influences that affect the employment of military capabilities.

d. The JOE provides the framework for the development of more specific concepts that are intended to accomplish the strategic objectives and decisively prevail within the JOE. These concepts, in turn, provide a visualization of how joint and Army forces will operate 10-20 years in the future, describe the capabilities required to carry out the range of military operations against adversaries in the expected OE, and how a commander, using military art and science, might employ these capabilities to achieve desired effects and objectives. Concepts enable the development of future capability descriptions within a proposed projection of future military operations. Each concept describes the operational challenges, the components of potential solutions, and how those components work together to address those challenges.

e. The force development process then determines Army DOTMLPF-P capabilities-based requirements and produces plans and programs that, when executed through force integration activities, brings together people and equipment and forms them into operational organizations with the desired capabilities for the combatant commanders. Force development uses a phased process to develop operational and organizational plans, and then combines them with technologies, materiel, manpower, and constrained resources to eventually produce combat capability.

f. The force development process interfaces and interacts with the Joint Strategic Planning System (JSPS), the Defense Acquisition Management System (DAS), the Joint Operations Planning and Execution System (JOPES) and the Department of Defense (DOD) Planning, Programming, Budgeting, and Execution (PPBE) process.

g. The products of force development provide the basis for acquiring and distributing materiel and acquiring, training, and distributing personnel in the Army to achieve the ultimate goal of fielding an effective and affordable force.

### Section III

## Force Development Phase I—Develop Capability Requirements

### 3-7. Joint Capabilities Integration and Development System

See Chapter 10.

### 3-8. Army Implementation of Joint Capabilities Integration and Development System Overview

a. The Army force development process begins with capabilities-based requirements generation. Army JCIDS develops an integrated set of Army DOTMLPF-P requirements that support national-, defense-, joint-, and Army-level strategy and operational needs of the combatant commands (CCMD). This process assesses joint and Army warfighting concepts in the context of the future joint operating environment to identify functional needs and solutions. The future operating environment describes the physical, demographic, political, economic, technological, and military conditions in which the Army will operate.

b. The Army portion of JCIDS is informed by the development of an Army Concept Framework (ACF). That includes the Army Capstone Concept (ACC), Army Operating Concept (AOC), Army Functional Concepts (AFC), and concepts directed by CG, TRADOC. These concepts provide an intellectual foundation for conducting Capabilities Based Assessments (CBA) of our current force's ability to meet future operational challenges. Properly applied, Army JCIDS produces an integrated set of DOTMLPF-P solution approaches that collectively satisfy the required capabilities (RC). The Army JCIDS provides traceability of all Army system and non-system solutions back to the associated strategies.

c. The Capabilities-Based Assessment identifies and documents capability gaps; determines the attributes of a capability or combination of capabilities that would fill the gaps; and identifies non-materiel and/or materiel approaches for possible implementation. The concepts-centric Army JCIDS process provides a robust analysis of warfighting capabilities required to prevail in the future operational environment. This process helps ensure the Army considers the most effective joint force capabilities and the integration of those capabilities early in the process. Appropriate component, cross-component, and

interagency expertise; science & technology community initiatives; and wargaming and experimentation results are considered in the development of DOTMLPF-P solutions.

d. Joint and Army JCIDS documentation—Initial Capabilities Document (ICD), Capability Development Document (CDD), Capability Production Document (CPD), and the DOTMLPF-P Change Recommendation (DCR's are for a non-materiel capability)—provides the formal communication of related DOTMLPF-P capability developments between the user and the acquisition, test and evaluation, and resource management communities (see Chap 10 for more detail on the ICD, CDD, and CPD).

### 3-9. Capabilities Development and Integration

ARCIC uses a collaborative approach to capabilities development and integration. The use of temporary teaming arrangements via integrated capabilities development teams or MOUs allows TRADOC to maximize integration efforts using limited resources. Proponent led teams also use a collaborative approach for capabilities integration during the concept and capabilities developments cycle. These teams efficiently expedite the JCIDS and acquisition processes through the early involvement of key stakeholders and SMEs from different agencies and services. Team membership varies but includes appropriate representation from across the Army, CCMDs, DOD organizations, and other federal agencies. Industry and academia participate as needed.

### 3-10. Concept Development and Experimentation

CD&E is a campaign of learning supporting current and future force development. Concepts, developed and refined through wargames and experiments, are the basis for determining the capabilities required for the future force. The translation of concepts into capabilities is an iterative process.

a. *Concepts.* Concepts are the centerpiece of the CD&E process. They establish the intellectual foundation for Army modernization and help Army leaders identify opportunities to improve future force capabilities. An operational concept is a generalized visualization of operations. It describes a problem to be solved, the components of the solution to that problem, and the interaction of those components in solving the problem.

(1) Concepts serve as the foundation for architecture development and for generating capabilities-based DOTMLPF-P solutions such as: doctrine modification and development, organizational design changes, training initiatives, materiel solutions, leadership and education requirements, personnel changes such as creating a new MOS or new skill identifier, facilities renovation and/or design, and policy modification or formulation/adoption. The DOTMLPF-P solutions are created through an evolutionary development process that results in improved capabilities.

(2) Components of an operational concept include a description of the future joint operating environment and its associated range of operational challenges, a set of concepts that address the “how to” of countering and overcoming the challenges posed, and a corresponding set of RCs and initial force design principles needed to implement the concept.

b. *Joint and Army Concept Development.* Fundamental ideas about future concepts of military operations and their associated capabilities are documented in operational concepts. To maximize their future utility, concepts are broadly based and encompass both the art and science of future warfighting, continually refined through wargaming, experimentation, assessment, and analysis.

(1) Joint concepts consists of a Capstone Concept for Joint Operations (CCJO), supporting Joint Operating Concepts (JOC) and Supporting Joint Concepts. These concepts address the period from just beyond the Future Years Defense Program (FYDP) out 20 years.

(a) *Capstone Concept for Joint Operations.* The CCJO is the vision of the CJCS and the overarching joint concept that guides joint force development, bridges strategy with operational concepts and future doctrine. The CCJO is approved by the CJCS. The CCJO articulates a high-order vision of how the future force will operate, describes the future operating environment, advances new concepts for joint operations, and suggests attributes that will define the future force. The CCJO aims to establish a bridge from strategic guidance to subordinate concepts, force development guidance, and follow-on doctrine. Service concepts and subordinate Joint Concepts (JCs) and Joint Capability Areas (JCAs) expand on the CCJO solution. The CCJO concludes by presenting risks and implications associated with the concept. The current CCJO is “globally integrated operations” with the following key elements: mission command; regional focus with global agility; leverage partners to maximize mutual advantage; flexible options in establishing joint forces—Active Component/Reserve Component (AC/RC) mix; cross-domain synergy; use of flexible, low signature capabilities; and discrimination.



(b) *Joint Operating Concepts*. JOCs link strategic guidance to the development and employment of future joint force capabilities and serve as “engines for transformation” that may ultimately lead to DOTMLPF-P changes. Collectively, JOCs describe required capabilities across the full range of military operations and encourage further examination through wargaming, joint training and a variety of studies, experimentation and analysis.

(c) *Supporting Joint Concepts*. Supporting Joint Concepts provides depth and detail to single and/or multiple JOCs by describing how the future Joint Force is expected to conduct a JOC mission or apply joint functions. Approved Supporting Joint Concepts drive the conduct of Capabilities-Based Assessments and other analyses designed to examine capability gaps and support the refinement and implementation of non-material and material solutions needed to achieve required capabilities and desired objectives specified in the concept.

(2) *Army Concept Framework*. The Army records its fundamental ideas about future joint operations in the ACF, promulgated in TRADOC 525-series pamphlets. The ACF consists of The Army Capstone Concept (ACC), the Army Operating Concept (AOC) and, the Army Functional Concepts (AFCs), and concepts directed by CG, TRADOC. Concepts facilitate the visualization and communication of the Army’s projections of future operations (see Fig 3-5).

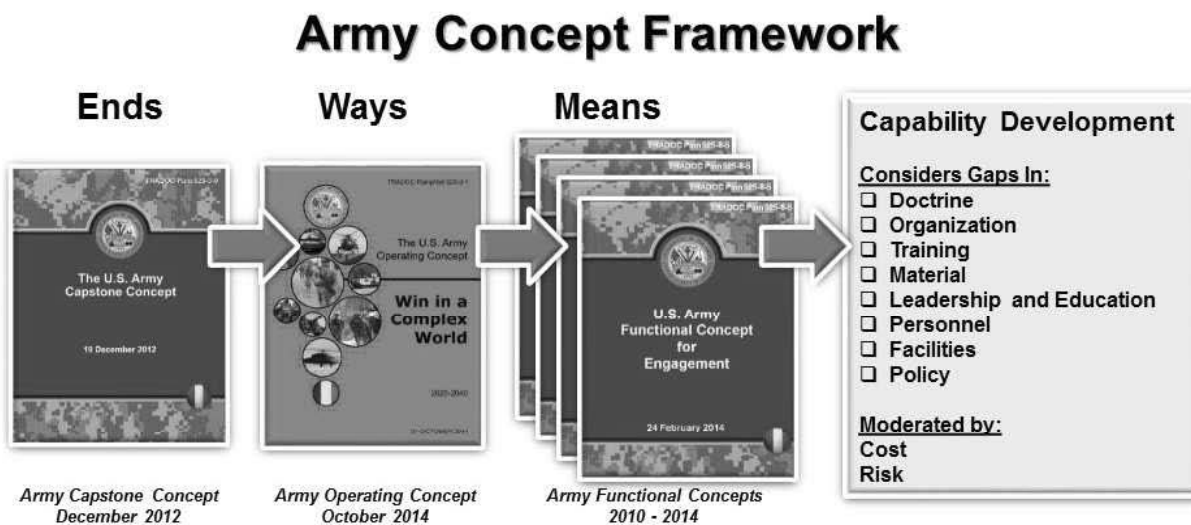

- **The Army determines its required capabilities starting with concepts**
- **Current concept work is focused on 2020 and refreshed every two years**
- **The Army organizes its concepts through warfighting functions:**
  - **Mission Command**
  - **Intelligence**
  - **Movement and Maneuver**
  - **Fires**
  - **Protection**
  - **Sustainment**
  - **Engagement**
- **Additional concepts address Learning and Training, Building Partnership Capacity, and the Human Dimension**

Figure 3-5. Army Concept Framework

a. The ACC is the lead document of the ACF. TRADOC Pam 525-3-0, The U.S. Army Capstone Concept, describes the Army’s vision of the future operational environment, the role of the Army in the joint force, and the broad capabilities required by future Army forces. The ACC provides a guide to how the Army will apply available resources to overcome unpredictable and complex challenges and prevent, shape and win in support of existing strategic guidance. The ACC also serves as the foundation for a campaign of learning that will evaluate and refine its major ideas and associated required capabilities.

Finally, the ACC provides a roadmap for development of a comprehensive investment strategy that will rebalance the Army's force structure, readiness, and modernization efforts in support of the national strategies. The ACC establishes that the Army must maintain a credible capacity to win decisively and support combatant commanders across a wide range of military operations at home and abroad. Further, the ACC retains the idea of operational adaptability as the fundamental characteristic of the Army required to execute a wide variety of missions for both the institutional Army as well as the operating force. Within the ACF, this concept is the baseline of a campaign of experimentation and analysis which will test these ideas. The ACC is the unifying framework for developing the AOC, AFCs, and integrated architectures.

(b) The AOC, documented in TP 525-3-1, The U.S. Army Operating Concept, describes how future Army forces operate to accomplish campaign objectives and protect U.S. national interests. It describes the Army's contribution to globally integrated operations outlined in the joint capstone concept. The AOC recognizes the need for Army forces to provide foundational capabilities required by the joint force and to project power onto land and across the air, maritime, space, and cyberspace domains. The AOC is grounded in a vision of future armed conflict that considers national defense strategy, missions, emerging operational environments, advances in technology, and anticipated enemy, threat, and adversary capabilities. Ultimately, the AOC guides future force development through the identification of first order capabilities that the Army must possess to accomplish missions in support of policy goals and objectives..

(c) The AFCs describe how the Army force will perform a particular military function across the full range of military operations 6-18 years in the future. AFCs support the ACC and AOC, as well as joint concepts, and draw operational context from those documents. Organized along the lines of the classic functions of a military force, the seven AFCs are Fires, Intelligence, Mission Command, Movement and Maneuver, Protection, Sustainment and Engagement. As an integrated suite of concepts, they describe the full range of land combat functions across the range of military operations. AFCs may include the details required to initiate the JCIDS Capabilities-Based Assessment.

(d) Two additional concepts devoted to the Human Dimension and the Army Learning Concept for Training and Education round out the ACF. The Army learning concept describes the learning model required by the future Army to develop adaptive, thinking Soldiers and leaders. The Army training concept outlines the requirements and capabilities of the future force to generate and sustain trained and capable units. TP 525-3-7 outlines how the Army will develop the cognitive, physical, and social components of every Soldier to operate within the Army in unified land operations. Collectively, the ACF defines the Army's vision of how it will operate in the future and provides the conceptual framework needed to determine the capabilities required across the Army to ensure future force effectiveness.

c. *Concept of Operations.* A CONOPS is a verbal or graphic statement, in broad outline, of a commander's assumptions or intent in regard to an operation or series of operations. A CONOPS is designed to give an overall picture of the operation and provides a useful visualization of how a future operation would be conducted. It is frequently embodied in campaign and/or operational plans, particularly when the plans cover a series of connected operations to be carried out simultaneously or in succession. When used in concept development, a CONOPS is a tool to help describe how a particular operation is conducted in the future.

(1) For joint concepts and the ACF, CONOPS provide the overall understanding of an operation and the broad flow of tasks assigned to subordinate and/or supporting entities. It presents the joint force or land component commander's plan that maps capabilities to effects to accomplish the mission for a specific scenario eight to 20 years into the future. CONOPS focus on describing the end-to-end streams of activities and how the commander might organize and employ forces to accomplish those activities.

(2) The following two types of CONOPS may be used in the joint concepts and the ACF concept development process:

(a) Illustrative vignettes provide operational context to describe how a joint force commander might organize and employ forces eight to 20 years into the future. These vignettes are used to clarify and increase understanding of the concepts.

(b) Defense Planning Scenarios (DPS) and Army scenarios (based on DPS) are written eight to 20 years into the future, in order to facilitate experimentation and Capabilities-Based Assessment under JCIDS. These scenarios have classified CONOPS that provide a high level of specificity and defined parameters to aid in robust analysis of capabilities and a comparison of alternate solutions.

(3) For near-term requirements, CONOPS have a different use. They are written to describe how a joint force and/or Army commander may organize and employ forces now through seven years into the future

in order to solve a current or emerging military problem. These CONOPS provide the operational context needed to examine and validate current capabilities and examine new and/or proposed capabilities required to solve a current or emerging problem. There is no strict format for a CONOPS used to support capabilities development, but it should cover the following areas at a minimum: the problem being addressed; the mission; the commander's intent; an operational overview; functions or effects to be carried out/achieved; and the roles and responsibilities of affected organizations.

d. *Force Operating Capabilities (FOCs).*

(1) The TRADOC ARCIC establishes required FOCs as the foundation upon which to base the JCIDS Capabilities-Based Assessment process. These critical, force-level, measurable statements of operational RC frame how the Army will realize future force operations as stated in the approved ACC, AOC, and AFCs. The FOCs help focus warfighting CD&E efforts. All warfighting capabilities-based requirements must have direct linkage through an FOC to an approved Army concept (capstone, operating, and functional) and the The Army Plan (TAP). FOCs are listed TRADOC Pamphlet 525-66 and periodically updated.

(2) TRADOC Pamphlet 525-66 also guides Independent Research & Development (IR&D) efforts. By providing the private sector an unclassified, descriptive list of desired FOCs, the Army is able to tap into a wealth of information and new ideas on different means to achieve those capabilities. The Army encourages industry to share these ideas with the appropriate Capability Developer (CAPDEV) and Training Developer (TNGDEV) organizations.

e. *Experimentation.* Experimentation is the heart of JCIDS. Experimentation explores warfighting concepts to identify joint and Army DCRs and capabilities needs. It provides insight and understanding of the concepts and capabilities that are possible given the maturity of specific technologies and capabilities that need additional research and development emphasis. The results of joint/Army experimentation help define the art of the possible and support the identification of DOTMLPF-P solutions to provide new capabilities. Progressive and iterative mixes of high fidelity Live, Virtual, Constructive (LVC) and simulations using real Soldiers and units in relevant, tactically competitive scenarios provide joint/Army leaders with FOC insights. Warfighting experiments are conducted to gain an understanding about some aspect of future warfighting Capability insights from warfighting experiments are "way points" used to plot the path to the future force.

(1) The Joint Staff, J-7 periodically publishes a joint development execution plan that examines joint development through experimentation. The plan provides a brief highlight of each experimentation project including its purpose, scope, end state, expected deliverables, and dates of completion.

(2) The Army also has an experimentation plan intended to examine future force development issues. It integrates Army CD&E in a coherent service and/or joint context to ensure the Army provides CCDRs with sustained land capabilities that are an indispensable, decisive component of the joint force. The objective of the plan is to validate Army concepts with the operational force prior to implementation, assess integration of significant, complex changes across the DOTMLPF-P spectrum, support the AOC central ideas; and through Army experimentation, provide Network Integrated Evaluations (NIE) with technology solutions ready for evaluation. Ultimately, the goal of CD&E is to reduce risk through learning, innovation, and pushing the limits of the possible. The Army experimentation plan is a holistic effort that inductively and deductively examines the future, supporting both current and future force development. Simply put, the Army experimentation plan is about what the Army must learn, when, and how. Army experimentation is hypothesis based, where the overarching hypothesis is that the future force capabilities will provide the joint force commander a means to rapid decision-making by providing a much broader range of decisive capabilities.

f. *Summary.* In summary, a robust CD&E program can optimize return on investment while acknowledging that there are elements of the future that cannot be planned. Conducting a deliberate and coordinated CD&E program enables transformation by ensuring some resources are allocated to prototyping emerging concepts and capabilities which, in turn, enable robust and adaptive transformation.

### 3-11. Capabilities-Based Assessment Process

a. The Army CBA is a structured JCIDS process. The three major phases of the Army CBA are the Functional Area Analysis (FAA), Functional Needs Analysis (FNA), and Functional Solution Analysis (FSA) (see Fig 3-6).

## Capabilities-Based Assessment Process

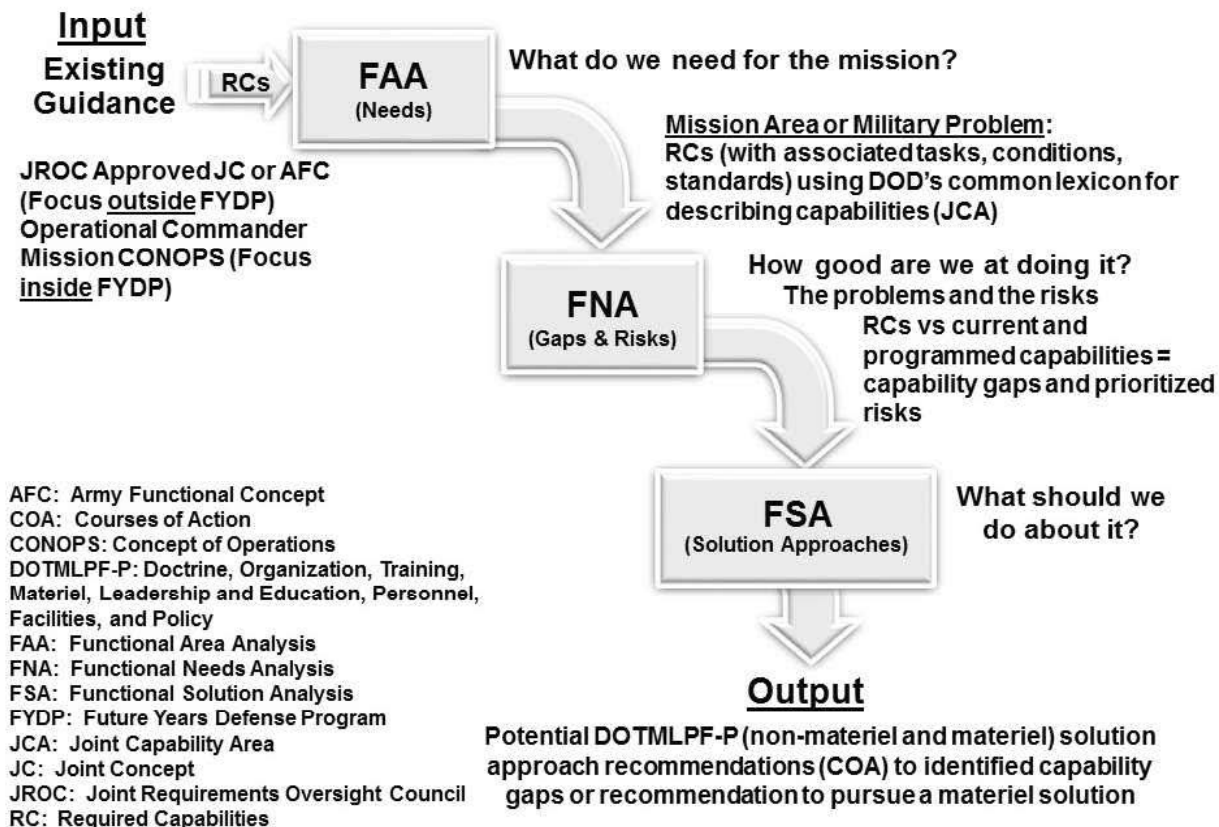

Figure 3-6. Capabilities-Based Assessment Process

b. *Future Joint Operating Environment (JOE)*. The Capabilities-Based Assessment process begins with an analysis of the future joint operating environment. As outlined in paragraph 3-6 above, the JOE describes the physical, demographic, political, economic, technological, and military conditions in which the joint/Army force will operate during the next 25 years. This cohesive vision of the future joint operating environment provides the common underlying context for all services' development of their respective Operational Environments (OE). The JOE serves to help synchronize service modernization efforts based upon a common set of base assumptions regarding the context of future threats and opportunities and related service-specific roles, missions and functions. Consequently, the JOE serves as a foundation for both joint and service concepts that, in turn, provide the framework for a more detailed Functional Area Analysis (FAA).

c. *Functional Area Analysis*. The FAA is the first analytical phase of the JCIDS-directed Capabilities-Based Assessment. Strictly a capabilities-based task analysis, the FAA provides the framework to assess Required Capabilities (RCs) in the follow-on Functional Needs Analysis (FNA).

(1) The input to the FAA is an approved Joint Capability Area (JCA), Army Functional Concept (AFC), or CONOPS that describes how the force will operate, the timeframe and environment in which it must operate, its RCs (in terms of missions and effects), and its defining physical and operational characteristics. The FAA must start with the military problem to be examined. The FAA isolates the RCs documented in the concept, identifies those tasks that the force must perform, the conditions of task performance, and the required performance standards. The output is a list of RCs and associated tasks and attributes. Mapped to each RC, the tasks, conditions, and standards are developed to the level required for analysis against which current and programmed capabilities will be evaluated in the follow-on FNA. Not all warfighting concepts will necessarily generate an FAA.

(2) The FAA is based on professional military knowledge of established doctrine and standards and modified to account for the projected concept for future operations and organizations. The FAA employs operational analysis that is primarily qualitative in nature. The analysis must identify the tasks that must be performed to accomplish the mission or achieve effects, and the specific conditions (e.g., weather, terrain, threat) in which the tasks must be performed. The performance standards developed for required tasks are found in the Army Universal Task List (AUTL), Universal Joint Task List (UJTL), approved concepts, or based on operational experience.

d. *Functional Needs Analysis.* The FNA is the second analytic phase in the Capabilities-Based Assessment. It assesses the ability of current and programmed Army capabilities to accomplish the tasks identified in the FAA, in the manner prescribed by the concept, under the full range of operating conditions, and to the prescribed standards. The FNA will identify any gaps and overlaps in capabilities and the risk posed by those gaps. The FNA determines which tasks identified in the FAA cannot be performed, performed to standard, performed in some conditions, or performed in the manner that the concept requires using the current or programmed force; and which of these gaps in capability pose sufficient operational risk to constitute needs that require a solution. Capability needs are defined as those capability gaps determined to present unacceptable risk. Following the FNA, the Director, ARCIC will direct the CoE or proponent to proceed with an FSA for those needs considered critical to executing operations IAW the concept.

(1) The tasks, conditions, and standards identified in the FAA and a list of current and programmed capabilities are the inputs to the FNA. The initial output of the FNA is a list of all gaps in the capabilities required to execute a concept to standard. When these gaps are subjected to risk analysis, the final output is a list of prioritized gaps (needs), which are capabilities for which solutions must be found or developed. Not all capability gaps will be identified as needs.

(2) In its simplest form, the FNA is a comparison of RCs to existing and programmed capabilities and the identification of the corresponding gaps. It must accurately and fairly assess current and programmed solutions' ability to provide RCs when employed in the manner and conditions called for by the AFC and/or CONOPS. The FNA includes supportability as an inherent part of defining the capability needs. Emphasis will be placed on defining capabilities by functional domain, describing common attributes desired of subordinate systems, Family of Systems (FoS), or System of Systems (SoS) and non-materiel solutions. Required capabilities must address joint and coalition warfare applications. The issue of determining whether the risk posed by specific capability gaps rises to the level of need, and to decide the relative priority of competing needs is a leadership decision. The FNA must provide the Army's leadership with an understanding of the operational effect of each identified capability gap at levels ranging from the simplest functional or tactical task to tasks of potentially operational or strategic impact.

e. *Functional Solutions Analysis.* The FSA is the third analytic phase in the Capabilities-Based Assessment. It is an operationally based assessment of potential non-materiel DOTmLPF-P and/or materiel approaches to solving or mitigating one or more of the capability needs determined from the FNA. The FSA describes the ability of each identified approach to satisfy the need. The FNA high-risk capability gaps are inputs to the FSA. The outputs of the FSA are the potential materiel and/or non-materiel approaches to resolve the capability needs. The FSA is composed of two sub-steps: ideas for non-materiel DOTmLPF-P approaches; and ideas for materiel approaches.

(1) Approaches proposed by an FSA must meet three criteria: first, they must be strategically responsive and deliver approaches when and where they are needed; second, they must be feasible with respect to policy, sustainment, personnel limitations, and technological risk; and third, they must be realizable in that DOD could actually resource and implement the approaches within the timeframe required.

(2) Sub-step 1: Ideas for non-materiel approaches. Potential non-materiel solution approach recommendations are sometimes called DOTmLPF-P or DOT\_LPF-P. The first sub step in the FSA identifies whether a non-materiel (DOTmLPF-P) or integrated DOTMLPF-P approach can address the capability gaps (needs) identified in the FNA. It first determines how the needed capability might be met by changes in DOTmLPF-P or existing materiel short of developing new systems. These include changes in quantity of existing materiel, improving existing materiel, adopting other services' materiel, or purchasing materiel from non U.S. sources. If the analysis determines that the capability can be partially or completely addressed by a purely DOTmLPF-P approach, a DCR is prepared and appropriate action is taken IAW the JCIDS Manual. If it is determined that DOTmLPF-P changes alone are inadequate and that product improvements to existing materiel, adoption of other service or interagency materiel,

acquisition of foreign materiel, or a new materiel approach is required, the FSA process continues to sub step 2 below. Some capability proposals will involve combinations of DOTmLPF-P changes and materiel changes. Also, these proposals continue through the FSA process at sub step 2.

(3) Sub-step 2: Ideas for materiel approaches. Materiel approaches or courses of action are identified to provide the RCs. The collaborative nature of this effort is meant to develop potential joint solutions. The process brainstorms possible materiel approaches and always includes existing and future materiel programs that can be modified to meet the capability need. The DOTmLPF-P implications of a materiel solution must always be considered throughout the process.

f. *Capabilities-Based Assessment Recommendations.* A Capabilities-Based Assessment offers actionable recommendations for both non-materiel and materiel solution approaches (see Fig 3-7).

(1) Potential non-materiel solution approach recommendations include the following:

- (a) Change policy.
- (b) Change doctrine.
- (c) Create new and/or modify existing organizations.
- (d) Train and educate DOD personnel differently.
- (e) Acquire commercial or non-developmental items.
- (f) Acquire more quantities of existing items or commodities to include increases in manpower operational tempo, spare parts, and fuel supplies.
- (g) Create new personnel Military Occupational Specialties (MOS) or skill identifiers.
- (h) Create, move or realign infrastructure/facilities to address new mission areas.

(2) Materiel initiatives tend to fall into three broad categories (listed in terms of fielding uncertainty from low to high):

(a) Development and fielding of information systems (or similar technologies with high obsolescence rates) or evolution of the capabilities of existing information systems.

(b) Evolution of existing systems with significant capability improvement (this may include replacing an existing system with a newer more capable system, or simple recapitalization).

(c) Breakout systems that differ significantly in form, function, operation, and capabilities from existing systems and offer significant improvement over current capabilities or transform how we accomplish the mission.

g. TRADOC ARCIC tasks a CoE or proponent to develop the initial DOTMLPF-P capabilities document(s), such as the ICD and/or joint DCR. When documented, TRADOC ARCIC submits DOTMLPF-P solution sets to HQDA G-3/5/7 for ARSTAF staffing and VCSA validation via the Army Requirements Oversight Council (AROC) validation process (see Chap 10).

h. *Processes that may substitute for the Capabilities-Based Assessment.* DOD and the Army have several processes in place that can be used in lieu of a formal Capabilities-Based Assessment or supplement those analyses—

(1) *Joint Capabilities Technology Demonstration.* The Military Utility Assessment (MUA), which is completed at the end of the JCTD, may be a suitable replacement for the required analysis used as the basis for ICD preparation. MUAs that do not contain the critical elements of information presented in the ICD (description of the capability gap(s); associated tasks, conditions and operational performance standards/metrics; and how the materiel and non-materiel approaches and analyses from the JCTD addressed these factors), will be augmented with a final demonstration report to qualify the results as equivalent to an ICD. The MUA/final demonstration report will be used to support the development and subsequent AROC and/or JROC validation of the CDD or CPD. A CDD or CPD, as appropriate, will be developed for the JCTD to transition into a Defense Acquisition System Program of Record (DAS POR).

(2) *Prototypes.* Results of prototype projects and operationally validated quick reaction technology projects intended for direct transition to fielded capabilities may also be eligible for consideration as potential solution approaches. This consideration will be based on mission need validation and MUA processes as applied to JCTDs.

(3) *Joint Urgent Operational Needs Statement, Joint Emergent Operational Needs Statement, or Service's Urgent Needs Processes* (see Chap 10).

(4) *Army Capabilities Needs Analysis (CNA).* The CNA is the Army's integrated CBA which assess what the Army must do as the premier land component to meet its joint warfighting responsibilities. It can be used to fulfill analysis requirements in lieu of a normal JCIDS CBA. The TRADOC Army Capabilities Integration Center (ARCIC) leads execution of the CNA across TRADOC Centers of Excellence and Army Force Modernization Proponents. The CNA identifies, assesses, integrates, and orders the Army's

required capabilities (RCs), DOTMLPF solutions, capability gaps, and gap solution approaches based on risk assessments. The CNA phases are: Guidance and Direction; Preparation; Assessments; Aggregation; and Results Approval, and the AAR. Army's Capabilities Needs Analysis (CNA), also uses analyses of the Army Warfighting Challenges and identifies high-risk capability gaps as well as high-priority solutions essential to maintaining overmatch over increasingly capable threats. The CNA results drive Army Capabilities Development priorities (e.g., Army JCIDS actions (ICD/CDD/CPD) and Campaign of Learning (e.g., Experimentation, S&T, Joint Warfighting Assessments, and Integration Evaluations) and inform the Secretary of the Army and Chief of Staff of the Army for ARSTAF and ASA(ALT) Strategic Portfolio Analysis Review (SPAR) planning and POM development and resourcing priorities.

## Solutions Documents

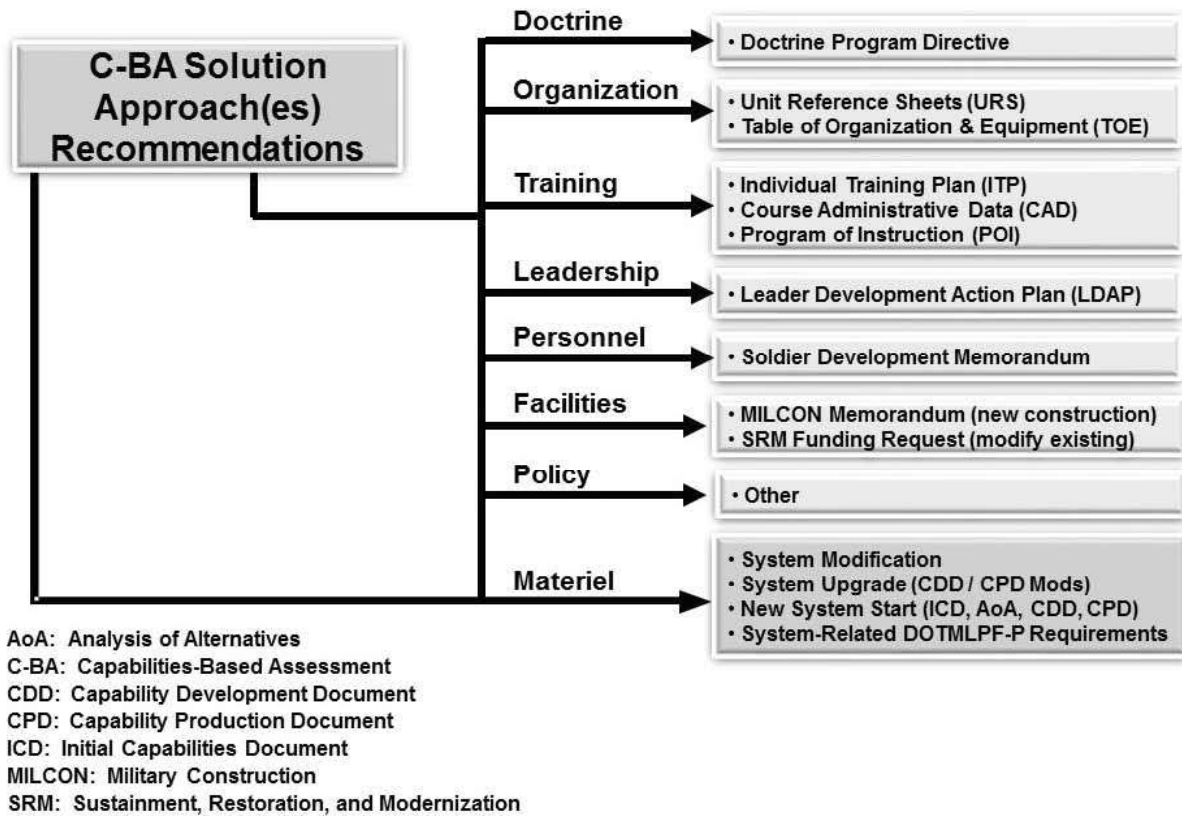

Figure 3-7. Solutions Documents

i. Overall, the capabilities-based Army JCIDS process examines the Army's current capabilities, postulates what future capabilities will be required, estimates what risks are associated with not fielding those capabilities, and compares those risks with what those capabilities may cost. The Army learned many lessons from the wars in Iraq and Afghanistan and accelerated, or rapid, fielding processes used to develop the Stryker Brigade Combat Teams (SBCT). These lessons have informed changes to how we generate current and future force structure requirements. Inserting an up-front and robust integrated analysis based on guidance from overarching joint and Army concepts allows informed decisions earlier in the process, producing optimal DOTMLPF-P solution proposals and making it easier to synchronize development and fielding. In addition, this process allows requirements to be traced back to national strategies, concepts, and policies, thus helping to eliminate redundant capabilities within the Army and DOD.

## Section IV Force Development Phase II—Design Organizations

### 3-12. Organizational Design

Organizational requirements flowing from the functional solution analysis determine whether a new or modified organization is required on tomorrow's battlefield. Once identified, organizational requirements are documented through a series of connected organizational development processes, to include: Unit Reference Sheet (URS) development; Force Design Update (FDU) process; Table of Organization and Equipment (TOE) development; Basis-Of-Issue Plan (BOIP) development, and Total Army Analysis (TAA). Every process may not always be required before organizational changes are made to the force structure and the processes may occur out of sequence. For instance, phase III, Development of Organizational Models, may start before the end of Phase II, Designing Organizations.

### 3-13. The Organizational Design Process

a. Organizations have their beginnings in warfighting concepts. These provide the conceptual basis for the proposed organization and address its mission, functions, and required capabilities. The Combat Developers (CBTDEV) at TRADOC Centers of Excellence and other force modernization proponents develop new organizational designs or correct deficiencies in existing organizations. The ARCIC Director integrates and validates concepts developed for future force capabilities. These concepts normally address:

- (1) Missions, functions, capabilities, and limitations.
- (2) Mission command linkages.
- (3) Individual, collective, and leader training requirements.
- (4) Sustainment in field and garrison.
- (5) Doctrinal impacts.
- (6) Impacts on materiel programs.

### 3-14. Force Design Update

a. The FDU—

(1) Includes capabilities development, capabilities determination, requirements approval, and implementation decisions.

(2) Develops organizational design solutions to overcome identified capability shortfalls that cannot be accommodated by doctrine, training, leadership and education, facility, or policy solutions. As part of the solution development, TRADOC CoEs force modernization proponents and non-TRADOC force management proponents consider courses of action across DOTMLPF-P with the intent of deriving materiel, personnel and organizational solutions as a last resort. Once an organizational solution becomes the recommendation, the force modernization proponent begins the integration process across the DOTMLPF-P domains.

(3) Includes minimum mission essential wartime personnel and equipment for new or modified organizations.

(4) Is developed by CAPDEVs within TRADOC, MEDCOM, Space and Missile Defense Command, and USASOC.

(5) Is coordinated with other CAPDEVs and other Army organizations having a specific interest, including all ACOMS, ASCCs, DRUs, National Guard Bureau, and Office of the Chief, Army Reserve (OCAR), and Tactical Wheeled Vehicle Requirements Management Office (TWVRMO). After FDU's are approved by the TRADOC FDU process review board, they are available as source documents for TOE development. TOE development is accomplished in parallel with the FDU process (see Fig 3-8).

b. TRADOC—

(1) Develops and provides FDU's to DCS, G-3/5/7 (DAMO-FMD) to develop new organizational requirements or changes to existing TOE organizations to meet current and evolving doctrinal requirements. DCS, G-3/5/7 (DAMO-FMD) is the single point of entry to receive the FDU from TRADOC, staff it with the ARSTAF in a FIFA analysis, and provide HQDA oversight of the FDU process.

(2) Submits FDU's to DCS, G-3/5/7 (DAMO-FMD) semiannually. Special OOC FDU's may be conducted to handle complex design issues or issues of special emphasis, such as those directed by HQDA. In addition, force modernization proponents can submit an FDU junior issue at any time. FDU Junior issues involve minor adjustments that normally do not impact other proponents, and do not cause



personnel growth including MARC growth.

(3) Performs FDU cost-benefit analysis (CBA) for submission to DASA-CE for validation (see Chap 10, Resource Management, for more details on the CBA). All FDUs and other force structure initiatives requiring an increase in resources must be offset to result in zero personnel growth (including grade) in the overall authorized force levels for each component. Any potential increase in equipment requirements must be reviewed for resourceability and supportability or include appropriate levels of funding to cover unbalanced growth.

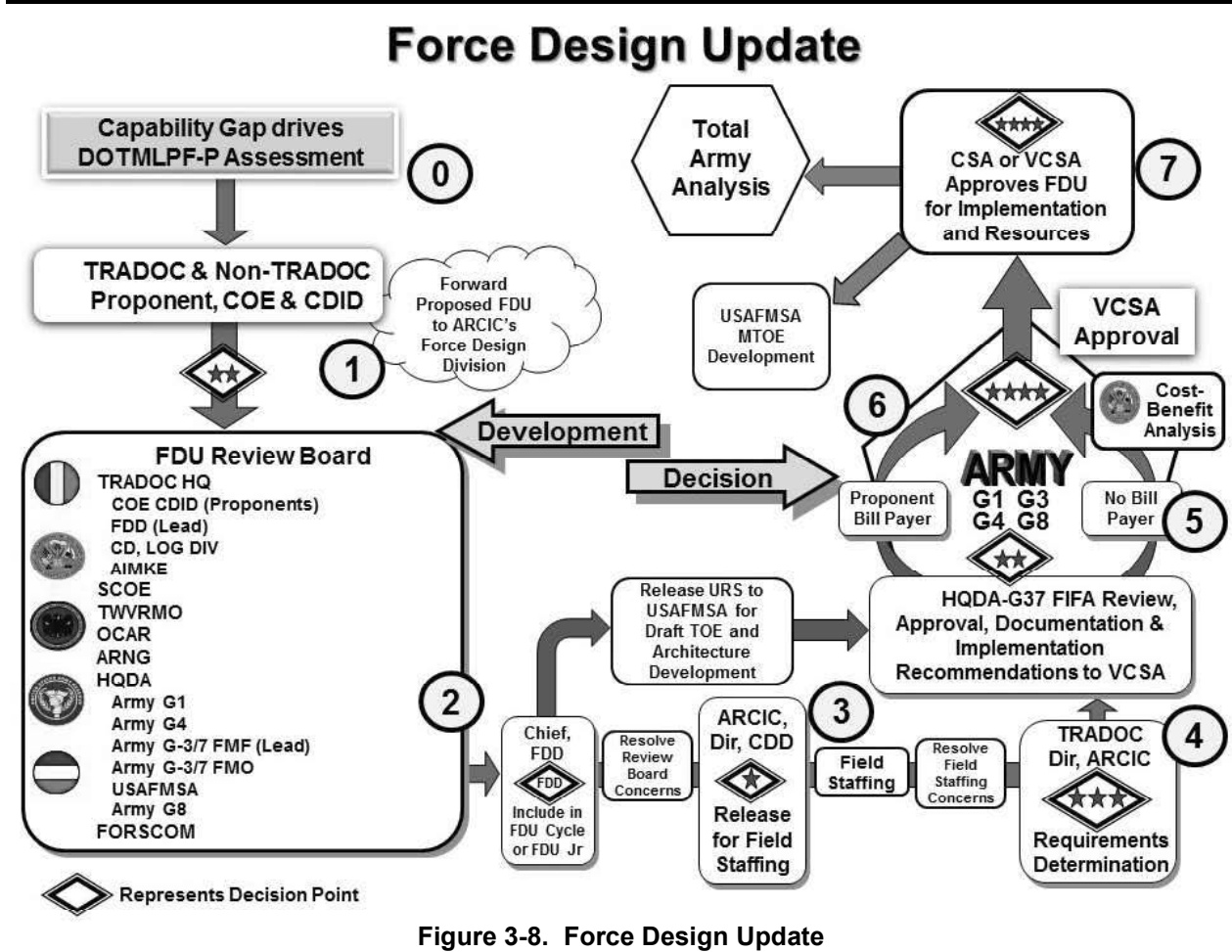

Figure 3-8. Force Design Update

### 3-15. Force Integration Functional Area Analysis

a. HQDA evaluates all proposed organizational changes by using a FIFA analysis to ensure designs are suitable, feasible, and acceptable. To be suitable, the proposed organizational design must accomplish the Army's mission and comply with VCSA and CSA guidance. To be feasible, the proposed organization design (unit, branch, echelon) must have the capability to accomplish the mission in terms of available resources. To be acceptable, the transformational advantage gained by executing the organizational design must justify the increased cost in resources.

b. The FIFA analysis reviews force structure issues and the impacts of force structure decisions on the Total Army. The FIFA determines the ability for the force to be structured, manned, equipped, trained, sustained, funded, and stationed. The FIFA analysis process analyzes the force to assess affordability, supportability, and sustainability. The FIFA analysis may provide alternatives based on prior initiatives, unalterable decisions from Senior Leaders Department of the Army (SLDA), or program budget decisions.

c. FIFA can result in one of three recommendations—

- (1) Implement the change and find resources

(2) Return to TRADOC for further analysis

(3) Prioritize the issue of resourcing in the next TAA.

d. The nine FIFAs provide the basis for transitioning organizations from one level of capability to a higher level. FIFAs help force managers assign functional responsibility for issues and integrate the solutions. They are considered and/or applied against a draft TOE or URS. The 9 FIFAs are—

(1) *Structuring*. An organization is properly structured to accomplish its doctrinal mission when the organization, its field maintenance and/or sustainment maintenance structure, and the support infrastructure, have accurate requirements documents, registered UICs, and HQDA-approved authorization documents.

(2) *Manning*. An organization is properly manned when the organization has assigned all authorized personnel by grade and skill.

(3) *Equipping*. An organization is properly equipped when the organization has the equipment authorized, including the following: major end items; TMDE; special tools and test equipment; maintenance floats.

(4) *Training*. An organization is properly trained when: all required Army training, including new equipment training is completed and evaluated according to mission essential task list standards; all authorized organizational training support materiel and training devices are in unit hands; all institutional training courses and training systems, training ammunition, and training facilities are available; and all doctrinal publications are on hand.

(5) *Sustaining*. An organization can be properly sustained when all authorized organization-level non-combat personnel are assigned; all support equipment, facilities, spares, and supplies are on hand; the field maintenance and/or sustainment structure and any support infrastructure is structured, equipped, trained, manned, sustained, stationed, and funded to sustain the supported organization; all support publications are on hand; and the organizations have valid DOD activity address codes.

(6) *Funding*. An organization is properly funded when: all costs associated with the organization and its field maintenance and/or sustainment structure have been identified, programmed, and resourced; and funds are available to support activation, reorganization, conversion, stationing, property turn-in or transfer, transportation, facility construction or renovation, and operational tempo.

(7) *Deploying*. An organization is deployable and/or employable when its field maintenance and/or sustainment structure, and associated units, are structured, equipped, trained, manned, sustained, stationed, and funded to operate as an element of an Army component command.

(8) *Stationing*. An organization is properly stationed when the organization and its field maintenance and/or sustainment structure have all required organizational facilities and support infrastructure in place. No degradation of quality of life, safety, or environmental standards can exist.

(9) *Readiness*. An organization is ready when its overall rating and commodity area category levels are consistent with current Army readiness standards in accordance with AR 220-1 and AR 525-30.

e. An approved FDU should support and accomplish each FIFA.

### Section V

#### Force Development Phase III—Develop Organizational Models

##### 3-16. Table of Organization and Equipment and Basis of Issue Plan Development

a. Organizations in the process of being designed in the preceding phase become the start point for the next phase. Following the first level of approval of the URS during the FDU process, the design goes to U.S. Army Force Management Support Agency (USAFMSA) for documentation as a TOE. The USAFMSA and the U.S. Army Special Operations Command (USASOC) develop TOEs and BOIPs codifying the input from the URS basic design.

b. TOEs and BOIPs are developed using an Army-wide development system and database called the Force Management System (FMS). FMS features a relational database for both requirement and authorization documentation and other information management systems as well.

c. Although the organization design phase and organizational model development phase are depicted as separate processes, they are closely related and frequently overlap. The proponent organization designers and the USAFMSA TOE developers work closely to ensure that the designs reflect requirements consistent with doctrine and policy and include all the elements necessary to provide an

organization fully capable of accomplishing its doctrinal mission. The approved organization design should capture personnel and equipment requirements as accurately and completely as possible.

### 3-17. Table of Organization and Equipment Description

a. TOEs provide a standard method for documenting the organizational structure of the Army. A TOE prescribes the doctrinal mission, required structure, and mission essential wartime manpower and equipment requirements for several levels of organizational options for a particular type unit. These organizational options provide models for fielding a unit at full or reduced manpower authorizations if resource constraints so mandate. A TOE also specifies the capabilities (and limitations or dependencies) for the unit.

b. TOEs provide the basis for developing authorization documents and provide input for determining Army resource requirements for use by force managers. These unit models establish increments of capability for the Army to develop an effective, efficient, and combat-ready force structure.

c. The TOE is a collection of related records in the database. There are a variety of records to include narrative information, personnel requirements, equipment requirements, paragraph numbers and titles, and changes in the form of BOIP records to name a few. A TOE consists of Base TOE (BTOE) records and applicable BOIP records.

d. Document developers construct a TOE in levels of organization based on the manpower requirements necessary to achieve percentage levels such as level 1 (100%) Minimum Mission Essential Wartime Requirement (MMEWR), or an organization partially manned by personnel other than Soldiers (level B). As TOE level 1 is the wartime requirement, it is what is reflected in the "required" column of the authorization document (Modified Table of Organization and Equipment (MTOE)).

e. FDU decisions, branch proponent input, and Army commands' issues, along with force design guidance developed during capabilities analyses, provide TOE developers with recommended TOE additions/modifications. Doctrine describes how each type of unit will perform its functions and details the mission and required capabilities. Policy and doctrine provide the missions and probable areas of employment of a unit. Policy includes guidance, procedures, and standards, in the form of regulations, on how to develop TOEs. Policy published in Human Resources Command's MOS Smartbook contains Standards of Grade (SG), duty titles, guidance for occupational identifiers (Area Of Concentration (AOC), MOS), skill identifier, Special Qualification Identifier (SQI), and ASIs used in the development of requirement documents and other organizational plans.

f. TOE developers consider the unit mission and required capabilities when applying equipment utilization policies, Manpower Requirements Criteria (MARC), SG, and BOIPs to develop the proper mix of equipment and personnel for an efficient organizational structure. Resource guidance limits the development of draft TOEs, as they must use resources available in the inventory.

### 3-18. Basis of Issue Plan Description

a. A BOIP is a requirements document that states the planned placement of quantities of new equipment and associated support items of equipment/personnel (ASIOE/P), as well as the reciprocal displacement of equipment and personnel (see Fig 3-9). It is often used to allow for the incremental modernization of Army units.

b. A BOIP is required for the following:

(1) Items to be procured in response to approved capability requirements documents and other requirements documents or materiel change management programs, which change the performance, characteristics, or capabilities of the item. These items require a new LIN and type classification of Logistics Control Code A (LCC A) (includes type reclassification standard from limited procurement or low rate initial production) (See AR 700-142).

(2) Items that require additional ASIOE/P (see AR 700-142).

(3) End items that are not required as components of sets, kits and outfits (SKO) and assemblies when they are to be separately type classified standard LCC A for separate authorization and issue.

(4) Equipment re-buys that require new technology, a new LIN for management, ASIOE/P, or items that result in an impact on training.

(5) BOIPs are not required for Component Major Items (CMI) when Standard Line Item Numbers (SLINs) are only required for reporting purposes.

(6) Exemptions from the BOIP process are listed in DA Pam 71-32.

c. BOIP Process.

(1) BOIP Feeder data (BOIPFD)

(a) Developing correct BOIPFD is the first step in the development of a BOIP. The BOIPFD is a compilation of information about a new or improved item of equipment.

(b) BOIPFD will be prepared by the MATDEV following an approved CDD and approved Milestone B decision and will support BOIP completion prior to the Milestone C decision.

**Modernization Over Time (Resource Driven)**

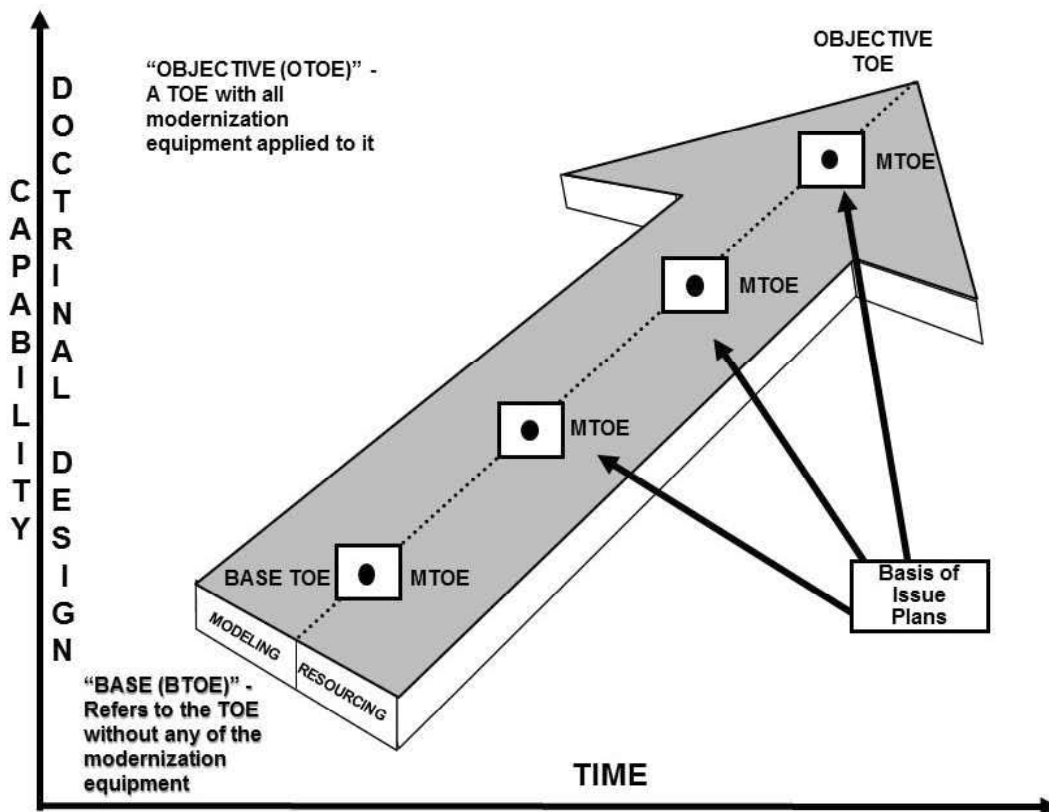

**Figure 3-9. Modernization Over Time (Resource-Driven)**

(c) BOIPFD will be prepared by the MATDEV and forwarded to USAFMSA within 60 days of the assignment of Developmental Line Item Number (ZLIN) for developmental items and within 30 days for a non-developmental item (NDI).

(d) When applicable, BOIPFD will include equipment modernization requirements for all schools in the One Army School System, both AC and RC, and in institutional training facilities.

(e) BOIPFD amendments will follow the same staffing process as initial submissions.

(f) Refer to ASA (ALT) policies and procedures for proposing and submitting BOIPFD.

d. BOIP Development and Staffing.

(1) The BOIP development process begins following the acceptance of BOIPFD in the Standard Study Number-Line Item Number Automated Management and Integrating System (SLAMIS). The appropriate USAFMSA branch chief, G-4 manager, and other interested parties (G-1, G-8, TWVRMO, and the Army MARC Maintenance Data Base (AMMDB) managers and other SMEs) participate in the review of the BOIPFD to ensure acceptability and affordability. If the BOIPFD is complete and error-free, the BOIP is accepted by G-37/FM and forwarded to USAFMSA to begin developing the BOIP. Following USAFMSA development of the BOIP, the BOIP is submitted to G-37FM for HQDA staffing.

(2) A HQDA-approved BOIP is required to establish Type Classification Standard (TC STD) designation and MS C decisions. Managers can submit waivers to continue the acquisition process without an approved BOIP through Deputy Commander, USAFMSA to DCS, G-3/5/7 (DAMO-FM) for Organizational Requirements Document Approval Briefing (ORDAB) General Officer Steering Committee (GOSC) decision.

(3) New or amended capability BOIPs (and MARC) are reviewed, validated, and approved by the ORDAB for all new or amended capability BOIPs (and MARC) to ensure correct basis of issue, personnel, materiel synchronization, and affordability. G-37/FM announces decision of BOIPs. The Council of Colonels (CoC) ORDAB is co-chaired by the Deputy Commander, USAFMSA, and the DCS, G-8 (DAPR-FDP) Resource Documentation Division Chief. The ORDAB GOSC is co-chaired by the DCS, G-37 (DAMO-FM), and DCS, G-8 (DAPR-FDZ). It comprises the following members: ASA (ALT); CIO/G-6; DCS, G-1; DCS, G-3/5/7 (DAMO-FM, DAMO-TR, DAMO-CI); DCS, G-4; DCS, G-8 (DAPR-FD); TRADOC; USAFMSA, ARNG, USAR and other SMEs as required.

e. Application of BOIPs to TOEs, MTOEs, and select TDAs. During BOIP development, USAFMSA documents the BOIP on the TOE. Once a BOIP is accepted, USAFMSA documents the BOIP on the TOE as a draft record, and promotes them to Approval Level 3 in preparation for the ORDAB CoC. The application of the BOIP to MTOEs is done in accordance with the Command Plan (CPLAN) cycle and adjusted as needed by DCS, G-3/5/7.

f. DCS, G-3/5/7 (DAMO-FM) announces BOIP decisions. A HQDA approved BOIP is required for ASA (ALT) to continue to TC/FRP at Milestone C.

## Section VI

### Force Development Phase IV—Determine Organizational Authorizations

#### 3-19. Determining Organizational Authorizations

a. The fourth force development phase, determining organizational authorizations, provides the proper mix of organizations, resulting in a balanced and affordable force structure. Force structuring is an integral part of the OSD management systems, PPBE and the Joint Strategic Planning System (JSPS). It is the resource-sensitive process portrayed in the “Determine Authorizations” section of the Army Force Management Model at Figure 3-1. This phase makes decisions on force structure authorizations in support of joint, strategic, and operational planning and Army planning, programming, and budgeting. Force structure decisions draw upon an understanding of the objectives, desired capabilities, and externally imposed constraints (e.g., dollars, total strength, roles, and missions).

b. The determination of the size and content of the Army force structure is an iterative, risk-benefit, trade-off analysis process, not all of which is exclusively within the purview of the Army.

c. TAA supports the evolving force structure transitions, providing the correct number and types of units over the POM period.

#### 3-20. Total Army Analysis

TAA is a two phase force structure analysis process that defines the required Army force structure within end strength and accounts for the military and DA Civilian requirements and authorizations necessary to comply with DOD guidance. TAA provides the basis for the Army's POM development and establishment of the POM Force (see Fig 3-10). The determination of the composition of the Army force structure, or shape, is an iterative, risk-benefit, trade-off analysis process.

a. Operational Force (OF) TAA. OF TAA shapes Army force structure and determines the best mix of organizations which are required and resourced as a balanced and affordable force and examines the projected Army force through both quantitative and qualitative analysis. The DCS, G-3/5/7 continuously updates the information, modeling, and analyses used to develop the Army POM Force. TAA is an integral part of the OSD PPBE and the CJCS's Joint Strategic Planning System (JSPS) and produces a balanced and affordable force projected to achieve *strategic objectives* within internal and external constraints.

b. *Generating Force (GF) TAA*. GF TAA determines the right size and composition of the GF to support the Army's future force structure requirements. This is accomplished through a yearly review of GF capabilities that addresses emerging capabilities growth, restructure initiatives, and rebalancing actions. GF TAA must—

- (1) Review TDA structure manpower requirements focusing on military and DA Civilian requirements with the goal of reducing those requirements no longer valid within the current documented capability.
- (2) Provide the SLDA the opportunity to prioritize GF capabilities, capacity, and manpower mix.
- (3) Provide a total Army programmed force and SACDB file as required to build a POM submission.

## Total Army Analysis “End-to-End” Process

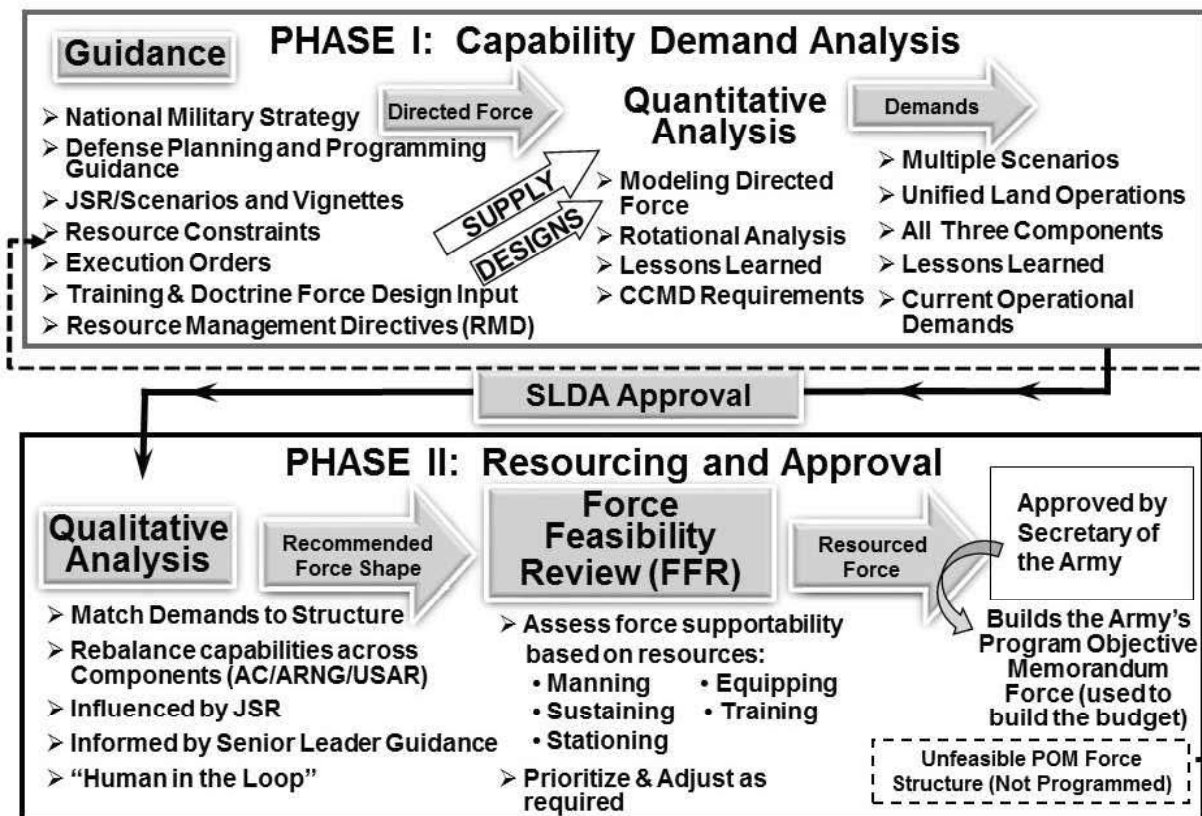

**Figure 3-10. Total Army Analysis “End-to-End” Process**

c. TAA Objectives.

- (1) Develop, analyze, determine, and justify a POM Force, aligned with OSD and/or joint staff (JS) DPG and TAP. The POM Force is that force projected to be raised, equipped, sustained, and maintained within resources available during the FYDP.
- (2) Provide analytical underpinning for the POM Force for use in dialogue among Congress, OSD, JS, CCDRs, and the Army.
- (3) Assure continuity of force structure requirements within the PPBE processes.
- (4) Provide program basis for structuring organizational, materiel, and personnel requirements and projected authorizations in SACDB.
- (5) Conduct an annual analysis of force structure options for programming consideration that includes the mix of OF and GF capabilities between the AC (COMPO 1), the ARNG (COMPO 2), and the USAR (COMPO 3) for the Secretary of the Army (SA) to consider and approve in support of the Army’s future total force and Secretary of Defense planning objectives.

### 3-21. Total Army Analysis Phase I—Capability Demand Analysis

The Capability Demand Analysis (CDA) Phase consists of force guidance and quantitative analysis. DCS, G-3/5/7 derives force guidance from numerous sources to include the NSS, NDS, NMS, and SLDA. Scenarios that are modeled are OSD approved and reflect a range of possible futures. Phase 1

begins by leveraging OSD scenarios from Operational Availability (OA) series analytical work, and Integrated Security Constructs (ISCs), to capture the Army's directed force (maneuver, fires and effects) Operating Force (OF) requirements. The scenarios are modeled and analyzed to develop the appropriate OF within the authorized end-strength necessary to accomplish the Unified Land Operations missions with minimum risk. Accurate planning, consumption and workload factors, threat data, and allocation rules ensure accurate computer-modeled demands. This demand list, combined with previous TAA scenario demand lists, CCDR war plans and operational deployment data are used to help determine the best mix of forces for the Army within authorized end strength. It is not intended to be used to determine the size of the Army. Because of the scenario size and complexity required to ensure every capability is fully exercised across the full Range Of Military Operations (ROMO), the range of demands on OF capabilities will likely far exceed the capabilities resident within the authorized end-strength. Phase 1 concludes when the SLDA review and approve the modeled and analyzed capability demands, which provide the doctrinally required units to meet the ISC demands. TAA builds a POM Force with which the PEGs can develop their portion of the Army's budget. The POM Force will also determine the OF enabler support force structure. It defines the Generating Force (GF) necessary to support and sustain the OF capabilities directed in strategic guidance. Capability Demand Analysis is made up of two separate events: force guidance and quantitative analysis.

a. *Force Guidance.* Force guidance consists of data inputs and guidance from various sources (see Chap 2, Strategy, for national-, defense-, joint-, and Army-level force guidance documents and processes).

b. *Data and Guidance Inputs.*

(1) *Homeland Defense (HD).* NORTHCOM and PACOM have the responsibility to develop and identify the missions, threats, areas of responsibility and Army force structure demands to accomplish HD.

(2) *Analytic Agenda.* OSD provides the directed scenarios, surge events (major campaigns) and vignettes within the Analytic Agenda.

(a) Primarily focused on strategic analysis of future force capabilities (force effectiveness and sufficiency).

(b) Integrated Security Constructs. Each ISC comprises multiple, simultaneous activities occurring over a multiyear timeframe to create one possible future; the product includes Combatant Command foundational activities (from the vignettes and scenarios), concepts of operations, and associated data for each of the major activities.

(c) Future force structure requirements are generated by national- and defense-level strategy (see Chap 2, Strategy).

(d) OSD has executed several OA studies to determine mid-term warfighting scenarios or vignettes. They provide the OSD-approved scenarios.

(3) *Force-Sizing Construct.* Guidance from OSD in the DPG scenarios dictates force sizing (see Chap 2, Strategy).

(4) *Foundational Activities.*

(a) Develop force requirements for CCDR activities to prevent conflict and deter adversaries over time.

(b) Other challenges to developing force demands in support of a range of multiple, simultaneous operations at home & abroad (e.g., Stabilization, COIN, defeat regional aggressors(s), support to civil authorities in the U.S.) with the purpose of ensuring each capability is addressed across the full ROMO.

(5) *Parameters, Planning and Consumption Factors, and Assumptions.*

(a) HQDA DCS G-4, TRADOC, MEDCOM, U.S. Army Combined Arms Support Command (CASCOM), the theater commands and other elements of the HQDA staff (G-1, G-3/5/7, G-4, G-6 and G-8) provide specific guidance, accurate and detailed consumption factors, planning factors, doctrinal requirements, unit level rules of allocation, network requirements, weapons and munitions data, and deployment assumptions. The Center for Army Analysis (CAA) then conducts the series of Modeling and Simulation (M&S) iterations that are analyzed to develop and define the total capability demands for logistical support necessary to sustain the combat force(s) in Homeland Defense, Army Support to Other Services (ASOS), Foundational Activities, each Major Combat Operation (MCO), and the GF.

(b) The parameters, factors, and assumptions contain theater-specific information concerning logistics and personnel planning, consumption and workload factors, host-nation support (HNS) offsets and other planning factors crucial to theater force development.

(6) *Rules of Allocation.* Another critical step during the force guidance development is the review and updating of support-force rules of allocation used by the CAA during the modeling process (quantitative analysis).

(a) These rules of allocation, developed by TRADOC and the functional area proponents, represent a quantitative statement of doctrine for each type of unit (maneuver, fires, effects, support and sustainment). They are adjusted as necessary to incorporate theater-specific planning factors. There are three basic types of rules. First, direct input, or manual, rules are stand-alone requirements for OF or GF units in a theater which are not doctrinally required in the warfight, but required to support the warfight. Second, existence rules tie a requirement for one unit to another, where the allocation of units is based on the existence of other units, or a function of a theater's physical or organizational structure (e.g., for one large general purpose port, one Harborcraft Company requires one each Military Police Company, etc.). Third, workload rules tie unit requirements to a measurable logistical workload or administrative services in proportion to the volume of those services (e.g., one DS Maintenance Company per 375 daily man-hours of automotive maintenance, or one POL Supply Company per 2200 tons of bulk POL consumed per day).

(b) The rules of allocation need modification whenever unit TOEs, scenario assumptions, logistical support plans, or doctrinal employment concepts change.

(c) Council of Colonels (CoC) and General Officer (GO) level reviews ensure all rules of allocation are appropriate and approved for use in the current scenarios.

(7) *CoC and GO-Level Review.* These are decision forums where all the parameters, constraints, data inputs and guidance are identified and approved for inclusion in the current TAA cycle and CAA models.

(a) The term "GO-level" includes assigned Senior Executive Service (SES) personnel.

(b) The CoC reviews and recommends approval of all data inputs and required forces developed by CAA modeling.

(c) The GO-level review ensures all data input and guidance is appropriate and approved for use in the current scenario(s). It specifically addresses those unresolved issues from the CoC review.

c. *Quantitative Analysis.* Warfighting capability demands are determined in this phase. CAA, through computer modeling and analysis, generates the scenario generated requirements (OF only) for types of units needed to ensure success of the BCTs, support brigades and headquarters commands directed in the different scenarios. CAA accomplishes the modeling through a series of analytical efforts and associated computer simulations. CAA uses the apportioned force provided in the OSD and Army guidance for employment in the MCO scenarios.

(1) Operating Force (OF). The OF is those forces whose primary missions are to participate in combat and the integral supporting elements thereof (see JP 1-02):

(a) The TAA provides the number and types of BCTs.

(b) The CAA computer models and analysis generate resources (units or classes of supply) needed in each illustrative scenario. Based on the illustrative scenario, rules of allocation, and the capability demands generated for units or classes of supply, CAA modeling and analysis develops the unconstrained (minimum risk) demand for enablers to ensure success of the deployed BCTs in the warfight.

(2) Generating Force (GF). Army organizations whose primary mission is to generate and sustain the OF capabilities for employment by joint force commanders. As a consequence of its performance of functions specified, and implied by law, the GF also possesses operationally useful capabilities for employment by, or in direct support of, joint force commanders (FM 1-01). A more quantitative determination of GF resourcing is evolving through studies and the inclusion of processes and procedures to link OF needs to GF size, configuration and design.

d. *Review and Approval.* Phase I, Capability Demand Analysis, is complete after the CoC/GO-level reviews of the results of the range of demands produced for each capability (CAA modeling and analysis results, weighted and integrated with applicable TAA ISCs, CCDR Warplans and deployment data).

(1) The CoC/GO-level forums "review and approve" the warfighting capability as a fully structured and resourced force.

(2) The CoC/GO-level forums review and reach agreement on the force structure demands supporting HD, Army Support to Other Services and Foundational Activities and the appropriate level of inclusion of contractor support, use of strategic partners, joint capabilities, and other risk mitigation variables to appropriately scope the capability demands within total strength ensuring a focus on shaping the Army



and not on sizing the Army. The GO-level review recommends approval of the capability demands to the SLDA.

(3) The SLDA reviews and approves the capability demands. The SLDA review and approval is the transition to Phase II of TAA (Resourcing and Approval Phase).

### 3-22. Total Army Analysis Phase II—Resourcing and Approval

Resource determination consists of qualitative analysis and SLDA review. Phase 2 develops force-resourcing options within total end strength guidance for use in developing the POM Force. DCS, G-3/5/7 leads reviews of the POM Force at multiple levels, culminating in approval by the SLDA. During Phase II, Resourcing and Approval, the determination must be made as to the level of acceptable risk to be taken for each capability. These capability demands are based on Army leadership directives, written guidance, risk analysis, the Army force generation approach and input from the Combatant Commander's Daily Operational Requirements (CCDOR). The qualitative analysis is the most difficult and contentious facet of the TAA process because the analysis results in the distribution of scarce resources, impacting every aspect of the Army. Therefore, this phase requires extensive preparation by participants to ensure all force structure tradeoffs are accurately assessed and the best warfighting force structure is developed.

a. *Qualitative Analysis.* Qualitative analysis is conducted to develop the initial POM force, within total strength guidance, for use in the development of the POM. A series of resourcing forums, analyses, panel reviews, and CoC consider and validate the CDA analysis of those demands. The qualitative analysis begins in the CDA Phase as risk mitigation measures are applied but prior to the resourcing panels. The qualitative analysis will continue until the POM Force is approved by the SLDA.

b. The resourcing CoC is held in two separate sessions, Organizational Integrator (OI) Panels and Resourcing CoC.

(1) *Organizational Integrator (OI) Panels.*

(a) HQDA action officers and their counterparts enter an intense round of preparations for the resourcing panels. Since the quantitative analysis only determined capability demands for doctrinally correct, fully resourced maneuver, fires, effects, support and sustainment units, the determination of a need for additional units and the allocation of resourced units to Components (Active Army, Army National Guard (ARNG), and U.S. Army Reserve (USAR)), must all be accomplished during the OI Panels. HQDA bases force structuring options on an understanding of the objectives to be achieved, the desired capabilities and the constraints. The primary differences among various options are the extent to which risk, constraints and time are addressed. It is through the OI Panels that the "Art" of Force Management is applied to the "Science" introduced during the CDA Phase.

(b) The Resourcing CoC provides the opportunity for the ARSTAF, Army Commands, proponent representatives and staff support agencies to provide input, propose changes, and to surface issues related to the OI Panel recommendations. The issues focus on COMPO and center on resolving risk mitigation issues while balancing priorities. The AC/RC balance and total-strength concerns are key recommendation outputs of this CoC. It allows Army Service Component Commanders (ASCC) to verify that theater specific capability demands are satisfied by Army force structure assigned/apportioned to their commands to meet current CCDR OPLAN/CONPLAN warfighting requirements and CCDOR. The Resourcing CoC is typically a multi-day event chaired by the Director, Force Management (DFM), G-3/7.

(c) The resourcing CoC focuses on identifying and developing potential solutions for the wide range of issues brought to TAA. The OI and Force Integrators (FIs) are key individuals in this forum. The OIs have the responsibility to pull together the sometimes diverse guidance and opinions, add insight from a branch perspective, and establish the best course of action. The OIs pull all the relevant information together for presentation to the CoC. During these presentations, the OI reviews the Standard Requirements Codes (SRCs) of interest that fall under his/her area of responsibility, and presents recommendations on how to solve the various issues.

(d) The resourcing CoC integrates Generating Force issues and requirements, and reviews and resolves issues based upon sound military judgment and experience. The CoC forwards their recommendations and any unresolved issues to the resourcing General Officer Steering Committee (GOSC).

(2) *Force Feasibility Review.* The FFR process is the vehicle to analyze force structure options developed during the TAA process. The ARSTAF further analyzes the force, initially approved by the GO resourcing conferences, via the FFR. The FFR process uses the results of the TAA resourcing

conference as input, conducting a review and adjusting the POM force to assure it is affordable and supportable. At the macro level, within the limits of personnel, budgetary and timing constraints, the FFR determines if the POM force can be manned, trained, equipped, sustained, and stationed. The FFR process identifies problems with the POM force and provides alternatives, based on prior TAA initiatives, unalterable decisions from the Army leadership, or Program Budget Decisions (PBD), to the GOSC for determining the most capable force within existing or projected constraints. With the TAA/POM process on an annual schedule, the PEGs conduct the FFR each year while building the POM. Their feedback is injected back into the next OI Panel and Resourcing CoC.

(3) *Resourcing General Officer Steering Committee*. The qualitative phase culminates with the Resourcing GOSC. The GOSC reviews/approves the decisions of the Resourcing CoC and addresses remaining unresolved issues. The GOSC has evolved into a series of GO resourcing forums at the two- and three-star level. The GO forums review and approve the decisions of the resourcing CoC, and address remaining unresolved issues. The Resourcing GOSC approves the force that is forwarded to the SLDA for review and final approval.

(4) *Leadership Review*. After the resourcing conference, sequential GO resourcing reviews meet to resolve any contentious or outstanding issues. The SECARMY, Undersecretary of the Army, CSA, and VCSA attend the SLDA meetings. The SECARMY reviews and approves the POM force.

### 3-23. The Product of Total Army Analysis

a. *Army Program Objective Memorandum (POM) Force*. The product of TAA is the Army's POM Force, the force recommended and supported by resource requests in the Army POM. The resulting POM Force includes the programmed structure for all Army components throughout the POM years and provides the basis for development of the Army POM submission. The POM Force meets the projected mission requirements with acceptable risk within anticipated total strength and equipment levels. Upon approval, the POM Force is released via the Army Structure Memorandum (ARSTRUC) and/or with the Structure and Manpower Allocation System (SAMAS) lock point file, and becomes the basis for development of the Army's POM submission. The POM Force meets the projected mission requirements with appropriate risk within anticipated total strength and equipment levels. The final output should result in an executable POM Force. The Army forwards the POM Force to OSD with a recommendation for approval. All approved units are entered into SAMAS to create the POM Force. Overall, TAA is the proven mechanism for explaining and defending Army force structure for budget submission.

b. *Army Structure (ARSTRUC) Memorandum*. The product of the TAA and POM processes is the approved and funded force structure as specified in the ARSTRUC. The ARSTRUC memorandum is directive in nature. It is produced by Army G-37/FM (Force Management), provides an authoritative record of Army's Senior Leadership final decisions made during the TAA process, as well as changes made as part of the out-of-cycle process since the last ARSTRUC. The ARSTRUC memorandum directs the commands to make appropriate adjustments to their force structure at the unit identification code (UIC) level of detail during the next command plan. Commands record changes during the Command Plan process in the Structure and Manpower Allocation System (SAMAS), the official database of record for the Army. SAMAS, along with the BOIP and TOE files, provides the basis for Army authorization documentations (e.g., MTOE and TDA). Publication of the ARSTRUC Memorandum completes the TAA cycle.

c. The product of the TAA and POM processes is the approved force structure for the Army, which has been divided for resource management purposes into components:

- (1) COMPO 1—Active Army.
- (2) COMPO 2—ARNG.
- (3) COMPO 3—USAR.
- (4) COMPO 4—Requirements to accomplish the Army's missions; not resourced.
- (5) COMPO 5---Not Matched Units
- (6) COMPO 6---Prepositioned Stock
- (7) COMPO 7—Direct Host-Nation Support.
- (8) COMPO 8—Indirect Host-Nation Support.
- (9) COMPO 9—Logistics Civil Augmentation, which comprise force structure offsets.

d. Host-nation support agreements guarantee the COMPO 7 and 8 resources. COMPO 9 is an augmentation, not an offset, and represents the contracts for additional support and services to be provided by domestic and foreign firms augmenting existing force structure.

## Section VII

### Force Development Phase V—Document Organizational Authorizations

#### 3-24. Documentation Components Overview

a. The fifth and final phase of force development, the documenting of unit authorizations, can be viewed as the integration of organizational model development and organizational authorization determination. Battlefield requirements for specific military capabilities drive the development of organizational models. The results of this process are TOEs for organizations staffed and equipped to provide increments of the required capabilities. TOEs specify Army requirements. Determining organizational authorizations, on the other hand, is a force structure process that documents resources (people, equipment, dollars and facilities) for each unit in the Army.

b. Because the Army is comprised of a complex mix of personnel, each with one or more of a variety of skills, and many millions of items of equipment, there must be an organized system for documenting what is required and how much is authorized. More importantly, as the Army moves forward with transformation, modularity, equipment modernization, application of new doctrines, and the modification and development of resulting organizations, the Army must have a way of keeping track of changes that are made so that they may be managed efficiently and with a minimum of turbulence.

c. Each unit in the Army has an authorization document, either an MTOE or a TDA, identifying its mission, structure, personnel and equipment requirements and authorizations. These documents are essential at each level of command for the Army to function. A unit uses its authorization document as authority to requisition personnel and equipment and as a basis for readiness evaluations.

#### 3-25. Authorization Documents

Authorization documents align and integrate a specific organization's mission, functions, organizational structure, personnel and/or equipment requirements and authorization data in detailed and summary format. They provide the HQDA-approved authorizations to resource the organization's requirements.

a. *Modified table of organization and equipment (MTOE)*. An MTOE is a UIC- and EDATE-specific, resource-informed authorization document derived from a TOE through the application of HQDA-directed guidance and personnel changes at billet-and LIN-level of detail. It establishes the personnel and equipment authorizations to resource the Minimum Mission Essential Wartime Requirements (MMEWRs) to execute the organization's doctrinal mission, as documented in the TOE. USAFMSA builds and DCS, G-3/7 (DAMO-FM) approves MTOEs. USAFMSA publishes MTOEs for the current year, budget year, and first program year. MTOE organizations are primarily in the OF, but can be in the GF.

b. *Exception MTOE*. Exception MTOEs deviate from the TOE and its applicable BOIPs. The DCS, G-3/5/7, Director, Force Management (DFM), is the approval authority for all exception MTOEs. These exceptions will be re-validated every three years.

c. *Equipment-Only MTOE*. A set of equipment, pre-positioned for use by a rotational or deploying unit for a specific mission in a specific theater. This authorization document contains only equipment and does not provide requirements or authorizations for personnel. Current examples of equipment only MTOEs are Army pre-positioned stocks (APS), the European Activity Set (EAS), and the Korean Enduring Equipment Set (KEES).

d. *Table of Distribution and Allowances (TDA)*. A TDA is a UIC- and EDATE-specific authorization document that is not based on a TOE. It prescribes the organizational structure, the manpower and/or equipment requirements, and authorizations to perform a mission for which no TOE exists. TDAs can include military, civilian, and standard and commercial equipment. TDA manpower requirements are workload-based. Workload shall be in direct support of HQDA level directed missions and functions only. USAFMSA builds and DCS, G-3/5/7 (DAMO-FMZ) approves TDAs for the current year, budget year, and first program year. TDA organizations are primarily in the GF, but can be in the OF.

(1) *Augmentation TDA (AUGTDA)*. The AUGTDA is a form of TDA that augments an MTOE unit. It establishes organizational structure, personnel, and equipment required for the unit to execute administrative and operational functions beyond the capabilities of the MTOE. The AUGTDA can include military, civilian, and standard or commercial equipment.

(2) *Mobilization TDA (MOBTDA)*. The MOBTDA is a form of TDA that establishes the mobilization mission, organizational structure, and personnel and equipment requirements and authorizations for units authorized under the non-deployment mobilization troop basis subsequent to a declaration of

mobilization

e. *Joint Tables of Allowances (JTA)*. The JTA is an authorization document for equipment in support of joint organizations under the control of CCDRs and Standing Joint Force Headquarters. JTAs are applicable to all active elements of the Army, Navy, Air Force, Marine Corps, USASOC, and their supporting components and joint commands. USAFMSA creates and staffs JTAs for Deputy Commander, USAFMSA approval and HQDA publication, as necessary.

f. *Common Table of Allowances (CTA)*. A CTA is an authorization document for items of materiel required for common Army-wide use by individuals or MTOE, TDA, or JTA organizations. USAFMSA builds, approves, and publishes CTAs.

g. *Government-Owned, Contractor-Operated (GOCO) Equipment*. Government-owned contractor-operated equipment are listed on applicable authorization documents when they include nonexpendable equipment that the contractor requires to perform the contract (see Federal Acquisition Regulation, Part 45 (FAR 45.000); Defense FAR Supplement, Part 245 (DFARS 245.1); and Army Financial Acquisition Regulation Supplement, Part 5145 (AFARS 5145.1)). All government-furnished equipment, except for the categories listed in paragraph 7–17 will be documented in the appropriate TDA to compute replacement requirements.

## Section VIII Force Integration

### 3-26. Force Integration Overview

a. Force integration synchronizes Force Integration Functional Areas (FIFA) to execute force management decisions while considering resource constraints.

b. The mission of force integration is to improve warfighting capabilities with minimum adverse effect on readiness during the period of transition. Execution of the force integration mission includes—

- (1) Placing new or changed doctrine, organizations, and equipment into the Army.
- (2) Developing strategies for coordinating and integrating the functional and managerial systems that exist in the Army.
- (3) Assessing the impact of decisions on organizations.

c. Force integration encompasses processes, decision support mechanisms and products to manage change by—

- (1) Assessing requirements for changes in capability.
- (2) Ensuring consideration of growth alternatives.
- (3) Developing suitable, feasible, and acceptable concepts to execute programs.
- (4) Determining and recommending solutions.
- (5) Preparing and executing detailed plans of action.
- (6) Assuring feedback that validates or modifies actions and execution, as necessary
- (7) Considerations of facility requirements by location

### 3-27. Integrated Process Team

a. HQDA learned the value of Integrated Process Team (IPT) problem solving from the challenges of rapidly fielding the Stryker brigades, managing the modular conversions, and rebalancing the AC/RC. Correspondingly, teams of stakeholders meet to discuss and seek solutions to implementation challenges of force management initiatives. These cross-functional working groups have been able to work the complex issues faced by the accelerating pace of change in a manner superior to the linear and sequential methods used in the past. HQDA continues to use the team approach for force management. The three key staff officers that chair the major integrating working groups are the Requirements Staff Officer (RSO) assigned to the G-8, the Synchronization Staff Officer (SSO) assigned to the G-8, and the Department of the Army (DA) System Coordinator (DASC) assigned to the Assistant Secretary of the Army for Acquisition, Logistics and Technology (ASA (ALT)). They work with other team members including the G-3/5/7 Force Integrator (FI), the G-3/5/7 Organizational Integrator (OI), the G-8 Program Analysis and Evaluation (PA&E) action officer, the Document Integrators (DIs), the Personnel System Staff Officer (PERSSO), command managers, and Resource Integrators (RI). As required, representatives from Army Commands (ACOM), Army Service Component Commands (ASCC), Direct

Reporting Units (DRU), Reserve Components, and other functional area and special interest representatives are included in IPTs and in the staffing of related force management issues.

b. The integration team approach helps to ensure that every action is properly coordinated with representatives who have knowledge of the doctrine, design, structure, personnel, acquisition, equipping, resources, facilities, information management, and training activities that impact a unit. The G-8 RSO serves as the HQDA single point of contact and represents the HQDA position for DOTMLPF-P capabilities requirements. RSOs convene capabilities requirements teams to analyze, coordinate, refine, resolve critical comments and non-concurrences, and develop recommendations for the capability. The SSO is the counterpart to the RSO for the G-8 and serves as the HQDA single point of contact for the integration and synchronization of approved capabilities requirements in order to achieve the Army Strategy, Army Campaign Plan (ACP) priorities and modernization strategy. The DASC is the primary acquisition staff officer at DA. The DASCs are responsible for the day-to-day support of their assigned programs and serve as the PMs' representatives and primary points of contact within the Pentagon. These staff action officers are responsible for preparing, handling, and coordinating actions in their areas of expertise. For more detail on duties and responsibilities of these staff members (see Chap 10).

### 3-28. Force Integrator

The FI assigned to G-3/5/7 represent the interests of functionally dissimilar force-level organizations (e.g., the entire force structure from Modular Brigade through Theater Army). They are horizontal force-level integrators and work with brigades, regiments, divisions, and corps and Theater Armies. Responsibilities of the FI include—

- a. Assesses ability of functional systems to support major organizations.
- b. Recommends prioritization of resources.
- c. Assesses impacts of organizational change, at the appropriate force level, on readiness.
- d. Facilitates integration of units into major organizations.
- e. Evaluates and analyzes impact of incorporating personnel, facilities, equipment, doctrine, structure, and capability changes into major organizations.
- f. Ensures major units are represented in force integration and force planning processes (e.g., TAA, FDU, etc.).
- g. Assesses impacts of mid-range and long-range planning on major units including new doctrine, structure, manning, equipment, technology, facilities, stationing, strategic policy, and resource strategies.
- h. Links organization requirements to resource allocation.

### 3-29. Organizational Integration

a. Organizational integration is a part of force integration that focuses on organizations in the process of introducing, incorporating, and sustaining new structure, equipment, and doctrine into the Army. It manages the documentation, resourcing, fielding, and sustainment of assigned organizations as integrated packages of doctrinally aligned capabilities within resource constraints, focuses on increasing force capability while managing the organizational changes through prioritization of resources, management of information, synchronization of activities, and assessment of capabilities; and identifies how the force and equipment changes will effect facility requirements and work with the Office of the Assistant Chief of Staff for Installation Management (OACSIM) to ensure facilities and or resources are available to support the changes.

b. Organizational Integrator (OI). OIs are assigned to the G-3/7 FM Directorate and represent organizational interests of functionally similar organizations (e.g. Infantry, Armor, etc.). These individuals are organized into teams for Maneuver, Maneuver Support, and Maneuver Sustainment. The OI serves as the vertical integrator, in their area of specialization. Additionally, he or she provides subject matter expertise to the RSO regarding requirements documentation that deal with these functionally similar organizations. The duties of the OI include, but are not limited to, those listed below.

- (1) Analyzing, coordinating, refining, and developing recommendations on requirements.
- (2) Ensuring doctrinal linkage exists between organizational and current and emerging capabilities.
- (3) Coordinating approval of TOEs and BOIPs.
- (4) Participating in force management analysis reviews of all force management documentation.
- (5) Developing and coordinating the HQDA position on proposed TAA process changes.

c. Command Manager (CM). CMs (Force Structure) (CM(FS)) assigned to the G-3/5/7 represent the organizational interests of an ACOM/ASCC/DRU by managing its TDA units, and serves as the FI for the

command's MTOEs. The second focus of the CM is managing program budget guidance by ensuring that the manpower allocation for each ACOM/ASCC/DRU is accurately reflected in the SAMAS in compliance with Army leadership decisions and within manpower controls established by Office of the Secretary of Defense (OSD). Duties include the following:

- (1) Serving as point of contact for command plans and Concept Plans (CONPLANS).
  - (2) Maintaining the documentation audit trail on all additions, deletions, and other changes to unit MTOEs and TDAs.
  - (3) Producing manpower resource guidance for ACOM/ASCC/DRU Program and Budget Guidance (PBG).
  - (4) Managing command FSAs.
  - (5) Providing analysis and assessment of resource alternatives for organizational actions under consideration.
  - (6) Documenting current and programmed personnel strength, applicable Joint Research, Development and Acquisition (RDA) programs, and organization force structure.
  - (7) "Cross-walking" analysis of Army programming decisions with those of the DOD, Office of Management and Budget (OMB), and Congress.
- d. Document Integrator (DI). The DIs are assigned to the USAFMSA, a DCS, G-3/5/7 Field Operating Agency (FOA). The DI produces organizational requirement and authorization documents that implement approved Army force programs. Their duties include the following:
- (1) Documenting the unit mission and required capabilities by applying equipment utilization policies, Manpower Requirements Criteria (MARC), standards of grade (SG), and BOIP to develop the proper mix of equipment and personnel for an efficient organizational structure.
  - (2) Developing MARC that serves as HQDA approved standards for determining the Minimum Mission Essential Wartime Requirement (MMEWR) for staffing to accomplish maneuver support and maneuver sustainment functions in TOE and MTOE documents.
  - (3) Reviewing proponent-proposed or approved authorization documents to ensure compliance with manpower, personnel, and equipment policies and directives.
  - (4) Centrally building ACOM/ASCC/DRU authorization documents based on HQDA guidance, Command Plan, and input from the ACOM/ASCC/DRU.
- e. ACOMs, ASCCs, and DRUs. Force management staffs at these echelons manage the planning and execution of the force integration mission.
- (1) Document integration, including authorization document (MTOE and TDA) review, and database management.
  - (2) Systems integration, including requirements and authorization document review, the Materiel Fielding Plan (MFP) process, New Equipment Training Plan (NETP) review, and facilities support annex review.
  - (3) Organization integration, including the organizational assessment process, review of requirement and authorization documents, and doctrine review.
  - (4) Force structure management, including TDA manpower management and end-strength management.
  - (5) Force planning, including the TAA process, command plan process, force reduction planning and monitoring, and CONPLAN development.
- f. Corps, division, regiment, separate brigade, and installation. Force management staffs at these levels continue to manage force integration.
- (1) Force structure management, including authorization document management, Commander's Unit Status Report (CUSR) monitoring, and force structure review and analysis.
  - (2) Systems integration, including action plan development, distribution plans reviews, and facilities review.
  - (3) Organization integration, including organizational assessments, force structure review and analysis, and authorization document review process.

**Section IX  
Change Management**

**3-30. Table of Distribution and Allowance Change Management**

- a. To change a TDA, all commands and ARSTAF use the TDA change management or concept plan as means to request new organizations, or updates and changes to all AUGTDA and TDA organizations assigned to the AC, ARNG, and USAR regardless of if the UIC is categorized as an OF or GF unit.
- b. Not all changes to TDAs and AUGTDAs require a TDA Change Management Plan (CMP).
- c. If a TDA or AUGTDA change meets concept plan thresholds, the change is categorized based on the type and impact of change.
- d. See AR 71-32 for complete thresholds, category definitions, guidance, and procedures for submitting a TDA Change Management Plan.

CAT1: Staff with FM, No HQDA staffing, CBA or USAMAA review required	CAT2: Staff with FM, Limited HQDA staffing (e.g. G-1) but no CBA or USAMAA review required	CAT 3: Focused HQDA staffing but no CBA (if within thresholds) nor USAMAA validation required	CAT4: Full HQDA staffing, CBA and USAMAA validation required
<p><b>•Does...</b></p> <ul style="list-style-type: none"> <li>•Lift and shift reqs/auths*</li> <li>•Change position titles</li> <li>•Down grade Mil and Civ grades</li> </ul> <p><b>•Does not...</b></p> <ul style="list-style-type: none"> <li>•Grow requirements or authorizations</li> <li>•Change descriptions</li> <li>•Change branches/POSCO/MOS</li> <li>•Change man power mix</li> <li>•Change programmatic coding</li> </ul>	<p><b>•Does...</b></p> <ul style="list-style-type: none"> <li>•Paragraph Changes</li> <li>•Lift and shift reqs/auths</li> <li>•Change position titles</li> <li>•Change Mil and Civ grades</li> <li>•Change descriptions</li> <li>•Change branches/POSCO/MOS</li> <li>•Change man power mix</li> </ul> <p><b>•Does not...</b></p> <ul style="list-style-type: none"> <li>•Grow requirements or authorizations</li> <li>•Change programmatic coding</li> </ul>	<p><b>•Does...</b></p> <ul style="list-style-type: none"> <li>•Realign staffs</li> <li>•Realign/grow requirements</li> <li>•Change position titles</li> <li>•Change Mil and Civ grades</li> <li>•Change descriptions</li> <li>•Change branches</li> <li>•Change man power mix</li> </ul> <p><b>•Does not...</b></p> <ul style="list-style-type: none"> <li>•Change programmatic coding</li> <li>•Grow Authorizations</li> </ul>	<p><b>•Does...</b></p> <ul style="list-style-type: none"> <li>•Realign staffs</li> <li>•Realign/grow requirements</li> <li>•Change position titles</li> <li>•Change Mil and Civ grades</li> <li>•Change descriptions</li> <li>•Change branches</li> <li>•Change man power mix</li> <li>•Request Change programmatic coding</li> </ul> <p><b>•Does not...</b></p> <ul style="list-style-type: none"> <li>•Grow Authorizations</li> </ul>

\*lift and shift is defined as moving a requirement and/or authorization from the current approved document within a UIC to another location without changing the programmatic elements of the position.

**Figure 3-11. TDA Change Management Thresholds**

**3-31. Command Plan**

- a. The command plan (CPLAN) is the annual force management process designed to account for and document force structure decisions and directives. The CPLAN reviews the budget year and documents the first program year.
- b. The DCS, G-3/5/7 (DAMO-FMP) is the proponent for CPLAN.
- c. The command plan process is the primary process for disciplined management of organizational change in the Army. The CPLAN is designed to account for and document force structure decisions and directives from the Army leadership including those changes directed by OSD, submitted by the commands, or outlined in Congressional guidance. The CPLAN synchronizes organizational change with the delivery of resources, to react to changing requirements while minimizing organizational

turbulence through a deliberate decision cycle. DAMO-FM publishes the CPLAN guidance memorandum that provides guidance and milestones for the CPLAN submission and describes the actions that must be accomplished.

d. During the command plan process, the DCS, G-3/5/7 (DAMO-FM) directs production of the appropriate authorization documents (MTOE and TDA).

e. The CPLAN process results in updated MTOE and TDA documents that provide personnel and equipment requirements and authorizations for the total force at the grade, MOS, LIN and quantity level of detail through the FMS.

f. All ARSTAF, ACOMS, ASCCs, or DRUs will brief the DCS, G-3/5/7 (DAMO-FM) on their command plan in accordance with published CPLAN guidance and in accordance with updated guidance from DAMO-FM.

g. The CPLAN culminates in the approval of the Army MFORCE and the release of HQDA approved authorization documents.

### 3-32. Out of Cycle Process

a. The documentation out-of-cycle (OOC) process is a HQDA G-3/5/7 FM process that occurs between command plans. The OOC process is used for any document change to a given UIC that requires a matching SAMAS data value change for that UIC. The original HQDA-approved document is superseded by the OOC replacement document at the effective date of the OOC document.

b. There are three primary thresholds that warrant an OOC—

(1) Any change to a UIC's approved document information that is also reflected in the associated approved SAMAS subset. See AR 71-32 for a list of SAMAS documented subset data elements.

(2) Any change to an approved document that is directed as an OOC by the DFM.

(3) A change originally proposed as an administrative change escalated for OOC consideration by the USAFMSA Deputy Commander.

### 3-33. Administrative Change Process

a. Documentation administrative changes are changes to a HQDA-approved authorization document that are outside of the mandatory criteria for implementation of the HQDA G-3/5/7 OOC documentation process.

b. Documentation administrative changes must be approved by the USAFMSA Deputy Commander, with G-3/5/7 FM concurrence, prior to implementation.

c. Details of the administrative change are annotated in MTOE or TDA Section 1.

d. Monthly application of the Supply Bulletin 700-20 to HQDA approved requirements and authorization documents will be executed through the document administrative change process. These changes are not annotated in the Section 1.

e. There are three primary thresholds for an administrative change—

(1) Minor document corrective changes that do not correspond to SAMAS data elements.

(2) Application of previously codified HQDA guidance where the change does not constitute an OOC.

(3) Changes resulting in less than an aggregate \$100,000 equipment growth on the TOE will propagate to the associated MTOEs via the administrative change process.

## Section IX Force Generation

### 3-34. Sustainable Readiness

The Army builds readiness through the Sustainable Readiness force generation process in order to meet known demands while simultaneously retaining sufficient readiness within the total force to mitigate the risk of responding to likely contingencies. In the Sustainable Readiness concept, units continue to build progressive readiness for known demands, but retain and sustain some of that readiness following deployments to alleviate the risk of responding to possible contingency events. Units not deployed, build and sustain readiness and are resourced to attain affordable readiness levels in a measured band of excellence and are also prepared to respond to emerging contingencies. The cycling of known deployment requirements and contingency response responsibilities between units and COMPOs avoids the negative aspects of having units languish in extended periods of low “tiered” readiness and allows the



Army to dynamically allocate resources, raise force-wide readiness levels and lower the risk of responding to emerging contingency requirements. The Army SR model is still under development, currently being tested, and scheduled to be fully implemented in 2018. The proposed SR program has the following characteristics.

a. Sustainable Readiness Overview - Sustainable Readiness (SR) addresses known Global Force Management Plan (GFMAP) force requirements as well as optimizes preparations to respond to on-demand contingency operations. The SR model (SRM) seeks to sustain the highest affordable readiness levels across the Army consistent with available resources, planned deployments and high priority contingency response requirements. The SRM avoids wide variances in unit readiness levels associated with the previous wartime-driven Army Force Generation (ARFORGEN) model that primarily focused resources on preparing rotational forces for wartime deployment and employment at the corresponding readiness expense of returning and non-deploying active and reserve units. Importantly, the Reserve Component (RC) provides the largest pool of surge capabilities for emerging contingencies, therefore, SR attempts to operationalize the RC by leveraging the unique capabilities of ARNG and USAR forces to support primarily mid- to late-deploying force requirements. SR extends the Army's readiness planning horizon by managing the Army's readiness levels to meet requirements five years into the future. This helps to synchronize readiness resource decisions with the development of the Program Objective Memorandum (POM).

b. Sustainable Readiness Steps – Planning SR occurs in five basic steps (Fig 3-12). The first step is to estimate the total force readiness demands. The second is forecasting attainable readiness levels across the force consistent with overall army force capacity, projected resourcing levels and related unit readiness costs. The third is to compare the readiness requirements with forecasted readiness levels with the difference constituting the assessed risk. The fourth step is to mitigate this risk through multiple Army processes to include modifying the response force, changing army force structure, adjusting force mix (AC/RC) and re-allocating readiness objectives and planned program funding. The fifth and final step is to produce and execute a resource-informed force-wide readiness plan that programs readiness objectives for deploying and deployable units, synchronizes those objectives in the Army Synchronization and Resource Process (ASRP), and then assess the objectives in the Army Strategic Readiness Assessment (ASRA).

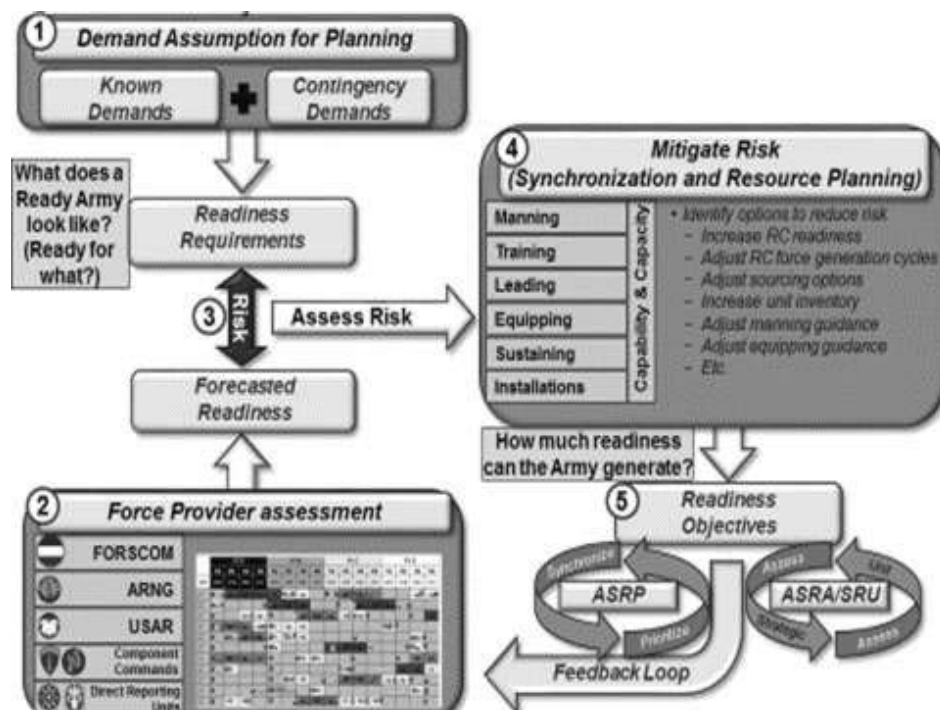

Figure 3-12. Sustainable Readiness Steps

(1) Step one: Capturing known force mission requirements and projecting contingency demands establishes the total force overall readiness demands. Current demands are outlined in the GFMAP and with other Joint Staff required missions, are forecasted five years into the future. Those known and forecasted missions will be distributed across the total force for the five-year planning period. Differently, the Time Phased Deployment Data (TPFDD) of existing war plans informs contingency force readiness requirements. The two demands, when combined and reconciled, provides the total force readiness requirements over the five-year planning period.

(2) Step two: Construct a force-wide readiness plan. The readiness plan outlines the unit readiness objectives by SRC unit, by quarter, over the five year time period together with the associated activities expected to achieve that objective. This projection delineates the Sustainable Readiness Model (SRM). A unit's quarterly readiness objective is portrayed with three different activity modules in the SRM: Mission, Ready, and Prepare. These modules are each three months long and aligned with fiscal quarters. Each module depicts a readiness 'activity' and an expected readiness 'outcome'. The 'Mission' module represents an allocated mission or a specified assigned force mission. These units will fill known demands and have a mission order from the Secretary of Defense or, if a CCMD assigned force, the Combatant Commander. The missions are categorized as either decisive action missions or non-decisive action missions. A unit whose ordered mission aligns with its unit design and Mission Essential Task List (METL) will conduct a decisive action mission. This unit could readily transition to a contingency mission, retain readiness during mission conduct, and more rapidly regain readiness following the mission. A non-decisive action mission involves a unit either broken apart from their design or conducting missions that are not aligned with the unit's METL. This unit loses readiness when deployed and must re-build readiness when returning. A unit not in a mission status but at a high level of readiness is in a 'Ready' module and prepared for contingency operations. All other lower states of readiness are represented by a 'Prepare' module. The Army assesses and adjusts these readiness projections, synchronizes the plan with the force providers, and matches readiness forecasts with total force readiness requirements. When modules are sequenced for every unit in the Readiness Plan over the 5-year planning period, the corresponding activities (prepare, ready, and/or mission execution) will represent a logical progression, or regression, in readiness leading to or from mission execution/periods of prepared-to-deploy. Over time, the planned 'activity' for each module will also allow for the standardization of associated resourcing levels for each unit type/SRC and allow the levels of resourcing to correspond to readiness outcomes.

(3) Step three: Risk assessment. Operational Risk will be assessed for specific unit-types, e.g., armored brigades or transportation companies. Operational Risk in SR is composed of Operational Depth Risk and Operational Readiness Risk. Operational Depth Risk assesses the ability to provide sufficient unit-specific capacity to meet wartime requirements. For instance, it answers questions such as: are there sufficient units to execute war plans and still meet known demands? Are there enough forces for replacements or sustained rotations? There is a 'high' Operational Depth Risk for a unit-type if there are not sufficient units to prosecute the likely contingencies and meet known requirements. Differently, Operational Readiness Risk assesses the ability to produce units at the right level of readiness to deploy in accordance with the associated TPFDD. Units that have less than 30 days to load onto transportation and deploy must be at the highest level of readiness. This level of readiness generally decreases in 30-60 day extensions beyond alert/mobilization. Later deploying units that have 100-plus days until the Ready to Load Date (RLD) would likely have sufficient post-alert/post-mobilization time to increase their readiness level before deploying. Accurate risk assessments require a nuanced understanding of each unit type's required time to achieve collective unit training readiness, the rapidity that collective training readiness degrades without sustained training, the importance of the unit type to the overall mission success and the projected influence on that success caused by lower levels of readiness of the unit type. These assessments coupled with available post alert/post mobilization time helps quantify risks and inform readiness objectives and resource allocations. These risk assessments greatly affect mitigation options and readiness planning courses of action examined in the fourth step.

(4) Step four: Mitigate risk. The mitigation of risk is most difficult to implement in-stride with an immediate response to an unexpected demanding crisis. Conceptually, US forces will already be committed to other missions, a limited number will be prepared to deploy at full readiness levels, and another group likely able to incrementally surge readiness to actually meet the new contingency deployment timelines. As a means to mitigate risk, some "ready" committed units may be diverted away from their current missions and re-deploy to the crisis; or other units may be deployed at lower levels of readiness. To meet mid- to long-term contingency force requirements and within available throughput

training, mobilization and strategic lift capacities, additional resources can be expended to accelerate readiness levels especially for the RC whose SM readiness cycles are measured in years vice quarters. For instance, if 20 ARNG units are on a 5-year plan, there will be 4 ready units every year prepared for deployment or deployed. If those units are moved to a 4-year plan, there will be 5 ready units a year. Additionally, ARNG and USAR training paths can be increased so that readiness is programmed to peak at a higher level (C1 vice C2) in their ready year, thus increasing units available for high risk contingencies. Conversely, other lower priority units' training regimens can be reduced that are not required in the contingency or where an abundance of that type units exist when compared to the contingency force requirements. The product of the mitigation analysis is the adjustment of the Readiness Plan through the re-distribution of Readiness Objectives across the total army to be achieved by the force providers in the 5<sup>th</sup> and final step.

**Modules: Three descriptive 3-month modules**

- Aligns force generation with quarterly training and readiness processes
- Provides common standards across the Total Army
- Clear representation of a unit's preparedness for decisive action
- Synchronization resource decisions and unit activities

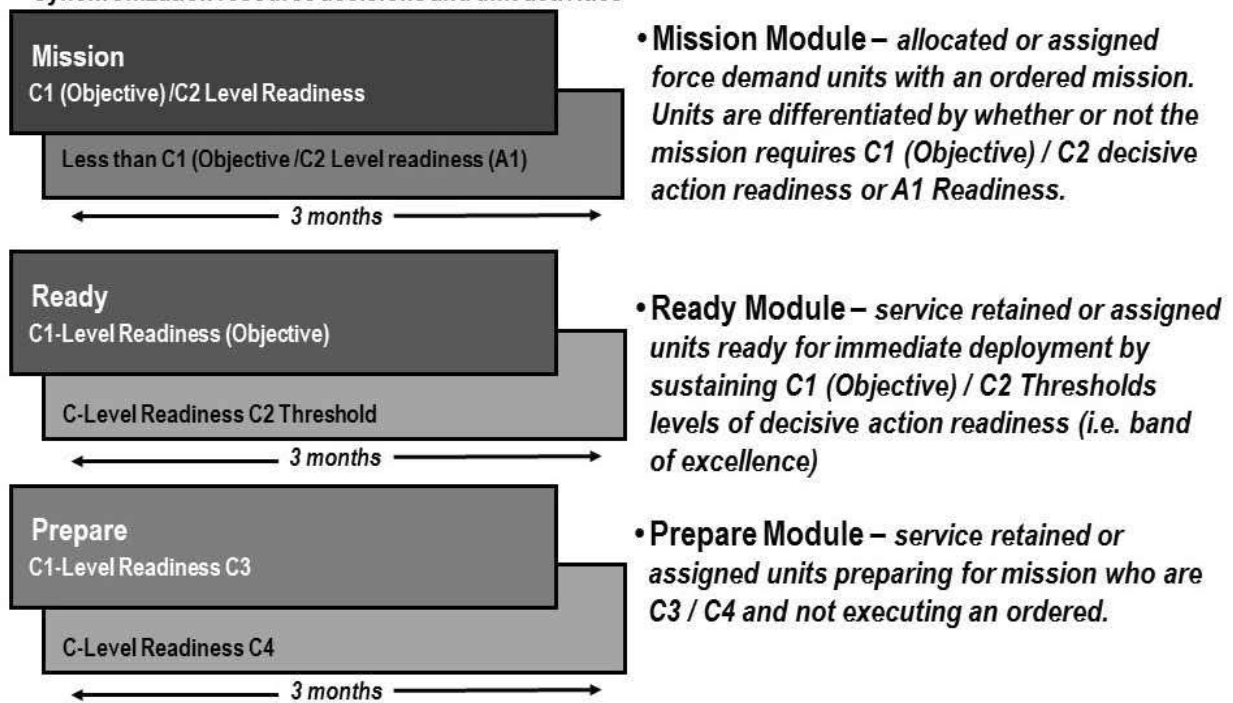

**Figure 3-13. Sustainable Readiness Modules**

(5) Step five: Execute, assess and revise. Readiness Objectives are the forecasted readiness targets from step two with the adjustments made in step four to mitigate unacceptable risk. These Readiness Objectives and associated resources are also captured in the Program Objective Memorandum (POM). They provide a guideline for the ASRP when they are reviewed and the actual missions ordered 18-24 months from execution. It is anticipated that the SR programmed readiness in the budget year will be much more accurately aligned with expected readiness needs of the ASRP than in the past. Feedback from unit attainment of forecasted readiness levels over time will assist readjustment of forecasting assumptions and planning factors for future SR cycles. Entering the execution year, the ASRA will provide fairly accurate feedback on readiness resourcing and related readiness objective attainment. Similarly, the planned readiness objectives for the next three years, as well as attainment of current

objectives, will provide insights that inform the ASRA and assist in making adjustments to the plan and improve forecasting.

c. The formal phases of the Sustainable Readiness Process are generally aligned with a calendar year and the readiness analysis will overlap in multiple years; not unlike the multiple POM and budget cycle overlaps. Phase one occurs four years before execution and establishes the readiness requirements and initial forecasted readiness levels. Three years from execution, the SR community assesses and mitigates risk by adjusting and re-programming readiness objectives. Two years from execution the ASRP, through two Army Synchronization and Resourcing Conferences (ASRCs), orders units to missions and finalizes readiness objectives for contingency forces. The last phase is the year of execution. Through the Strategic Readiness Update (SRU) and the Army Strategic Readiness Assessment (ASRA) the Army is able to assess the attainment of the planned readiness objectives and readjust resources, assumptions and projections of readiness objectives.

d. Sustainable Readiness Force Generation employs proven force generation methods that are measured and assessed through a comprehensive risk assessment directly linked to accomplishing national and combatant commander missions and responding to emerging contingency requirements. The process pushes readiness planning and management well into the HQDA resource planning windows to inform the budget and the POM. It provides the HQDA staff with a blueprint of readiness objectives for associated units that informs and prioritizes related resourcing, equipping, manning as well as unit training requirements. It also provides FORSCOM and the other force providers with a disciplined plan of unit readiness objectives that improves long range planning. Notwithstanding, it will not stop turbulence caused by unexpected changes to the operational and strategic environments; however, it will push planning timelines beyond the budget year and allow the force providers to prepare for known and projected demands over the FYDP and serve as a springboard to respond to changes. Finally, the readiness objectives distributed across every unit in the total Army provide the Army with the means to project force-wide readiness and make readiness-informed resourcing and deployment/mission decisions.

### Section X

#### Summary, Key Terms, and References

##### 3-35. Summary

a. In modern, complex organizations there is a cause and effect relationship involving almost every process and system. An appreciation of these interrelationships and knowledge of the individual systems that contribute to force management will in turn lead to an understanding of how the Army runs.

b. Changes within the Army and the processes used to implement those changes require a holistic application of cross-functional factors. To be successful, future senior Army leaders and managers must understand the nature of the interrelations of the systems and subsystems, as well as the key players and functions. Senior leaders who understand how these processes work and where leadership can influence these processes will be more effective. Experience shows us that successful senior leaders understand how the Army develops and sustains its part of our nation's military capability and use this knowledge to make informed decision on how to use or change the processes to improve that capability. The overviews of the Army Functional Life Cycle Model and the USAWC Model introduced in this chapter provide a basis for subsequent and more detailed examinations of the Army management systems and processes in later chapters. Additional information can be found at the following web sites:

- (1) <http://www.carlisle.army.mil>.
- (2) <http://www.afms1.belvoir.army.mil>.
- (3) <https://fmsweb.army.mil>.

##### 3-36. Key Terms

a. *Document Integrator (DI)*. Ensures that requirements and authorization documents meet approved Army force programs and link requirements, planned or programmed force structure actions, and the documentation processes (FM 100-11, 15 Jan 98, RESCINDED).

b. *Force Development*. The process of determining Army doctrinal, leader development, training, organizational, Soldier development, and materiel requirements and translating them into programs and structure, within allocated resources, to accomplish Army missions and functions (AR 71-32, DRAFT).

c. *Force Integration*. The synchronized, resource-constrained execution of an approved force development program to achieve systematic management of change, including: the introduction, incorporation, and sustainment of doctrine, organizations, and equipment in the Army; coordination and integration of operational and managerial systems collectively designed to improve the effectiveness and capability of the Army; and knowledge and consideration of the potential implications of decisions and actions taken within the execution process (AR 71-32, DRAFT).

d. *Force Integrator (FI)*. A manager of resourcing, documentation, fielding, and sustainment to assure doctrinal, operational, and technical integration of functionally dissimilar organizations. Responsible for the horizontal integration of large units such as brigades, regiments, groups, divisions and corps (FM 100-11, 15 Jan 98, RESCINDED).

e. *Force Management*. The capstone process to establish and field mission-ready Army organizations. The process involves organization, integration, decision-making, and execution of the spectrum of activities encompassing requirements definition, force development, force integration, force structuring, combat developments, materiel developments, training developments, resourcing, and all elements of the Army Organizational Life Cycle Model (AOLCM) (AR 71-32, DRAFT).

f. *Force Modernization*. The process of improving the Army's force effectiveness and operational capabilities through force development and integration (AR 5-22, 25 Mar 11).

g. *Force Structure*. The manpower and materiel composition, by number and type of organizations, of the current, planned, or programmed Total Army tasked to perform missions in peace and war (FM 100-11, 15 Jan 98, RESCINDED).

h. *Organization Integrator (OI)*. Branch assigned subject matter experts who: manage table of organization and equipment/modified table of organization and equipment units, by branch, to provide an operational view of change management; are the focal point for force accounting, documentation, resourcing, and readiness of assigned units; exercise resource controls for documentation; coordinate and recommend approval or disapproval of all branch specific actions and documentation; advise DCS, G-3/5/7 and G-3/7 Force Management on the disposition of branch actions at HQDA; and field access to the larger HQDA force management processes (PROPOSED, derived from AR 71-32, DRAFT).

i. *System Integrator (SI)*. The coordinator for determining requirements, assuring operational and organizational documentation, coordinating, planning, and programming fielding, and recommending resourcing priorities for designated functional areas or specific materiel systems (FM 100-11, 15 Jan 98, RESCINDED).

j. *Synchronization Staff Officer (SSO)*. Is charged with the synchronization of the JCIDS requirements process, DAS, PPBE and equipment allocation processes. The SSO recommends an affordable equipment modernization investment strategy that best balances approved equipment modernization requirements and available fiscal resources to meet ACP directed equipping objectives. Facilitates informed HQDA decision making to equip the force to meet Army Title 10 mission requirements.

### 3-37. References

- a. Army Regulation 5-22, The Army Force Modernization Proponent System, Rapid Acquisition Review (RAR), 25 Mar 2011
- b. Army Regulation 71-32, Force Development and Documentation, 1 Jul 2013.
- c. CCJO, 10 September 2012.
- d. CJCSI 3010.02D, JCD&E, 22 Nov 2013.
- e. CJCSI 3170.011, JCIDS, 23 Jan 2015.
- f. Department of the Army General Orders #4, Redesignation of the United States Army Training and Doctrine Command Futures Center as the Army Capabilities Integration Center, 10 Feb 2006.
- g. Department of the Army General Orders 2017-01, Assignment of Functions and Responsibilities Within Headquarters, Department of the Army, 05 Jan 2017.
- h. DODD 5000.71, Rapid Fulfillment of Combatant Commander Urgent Operational Needs, 24 Aug 2012.
- j. Headquarters (HQ) TRADOC, TRADOC Regulation 71-20, Concept Development, Capabilities Determination, and Capabilities Integration, 28 Jun 2013
- k. HQ TRADOC, TRADOC Regulation 25-36 C1, The TRADOC Doctrine Publication Program, 4 Sep 2012.
- l. Interview with Dempsey, Martin E., General, Chairman of the Joint Chiefs of Staff, 11 Feb 2015.

## HOW THE ARMY RUNS

- m. JCS J-8 Force Structure, Resources, and Assessments Directorate, Capabilities-Based Assessment Users Guide, Version 3, 01 Oct 2012.
- n. Public Law 99-433, DOD Reorganization Act of 1986.
- o. Public Law 103-62, Government Performance Results Act of 1993.
- p. Title 10, USC.
- q. TRADOC ARCIC, Capabilities-Based Assessment Guide, Version 3.1, 10 May 2010.
- r. TRADOC Pamphlet 71-20-3, TRADOC Concept Development Guide, 6 Dec 2011.
- s. TRADOC Pamphlet 525-3-0, The U.S. ACC, 19 Dec 2012.
- t. TRADOC Pamphlet 525-66 Force Operating Capabilities, 7 Mar 2008.
- u. TRADOC Regulation 71-20, Concept Development, Experimentation, and Requirements Determination, 28 Jun 2013.
- v. TRADOC Regulation 10-5, Organization and Functions, 21 Apr 2017.

## Chapter 4

### Army Organization

#### Section I Introduction

##### 4-1. Chapter Content

a. The United States Army is a strategic instrument of national policy that has served our country in peace and war for over two centuries. The Department of the Army (DA) is separately organized under the Secretary of the Army (SECARMY) (10 USC 3011). This chapter provides a discussion on how the Army is organized to perform its doctrinal tasks and how it responds to changes in its environment. The publications which provide the official description of Army organizations, as well as their roles, missions and functions include the following: DA Pamphlet (DA PAM) 10-1, Organization of the United States Army; DA General Orders (DAGO) 2017-01, Assignment of Functions and Responsibilities within Headquarters, Department of the Army; Army Regulation (AR) 10-87, Army Commands, Army Service Component Commands, and Direct Reporting Units; and AR 10-88, Field Operating Agencies, Office of Chief of Staff, Army (CSA). The Army web site at <http://www.army.mil/info/organization/> provides links to the home pages of the Army Headquarters (HQ) staff elements and the Army Commands (ACOM), Army Service Component Commands (ASCC), Direct Reporting Units (DRU), and Field Operating Agencies (FOA). These four types of managing headquarters and supporting activities, and their examples, are listed later in this chapter.

b. How the Army operates as a system within an organizational, operational, and strategic environment to carry out its Title 10 functions provides insight into how the Army efficiently allocates resources and effectively manages change. Through these processes, the Army is able to provide trained and ready forces to the CCDR for prompt and sustained combat incident to operations on land. What follows is a discussion of the framework that describes the Army as an organization of headquarters, staffs, commands, and functional units.

##### 4-2. The Army Organizational System

a. The Army as an Open Organizational System.

(1) In terms of management theory, the Army can be considered an open organizational system with three distinct components: the production subsystem; the combat subsystem; and the integrating subsystem. Each of these components includes tasks to be accomplished, operates in a given environment, and requires and acquires resources. Because of the size and complexity of the Army and its tasks, its corresponding organizational structure must provide as much flexibility as possible, given resources and mission requirements, while also maintaining the mission command necessary to accomplish the following: develop forces; marshal, deploy, and employ those forces; and sustain operations in support of a national strategy.

(2) The Army's organizational design has evolved over time and is continuously being adapted to ensure a goodness-of-fit between its overall structure and the conditions of the external environment. In essence, the Army exists as an open system and thus must be structured and restructured in such a way as to allow the system to adapt to external factors in the appropriate manner. To facilitate adaptation, the Army organizational system is composed of a combination of decentralized functionally-focused subordinate organizations empowered to adapt and make decisions to effectively and efficiently support or execute mission requirements. The Army system also has a centralized hierarchy designed to establish policies to effect coordination and cooperation between the sub-organizations and ensure cross functional integration and differentiation.

b. Integration and Differentiation. Every complex and open organization that is functionally organized

to allow for decentralized sub-optimization is also challenged with ensuring both the integration of its suborganizational outputs and continued differentiation of those organizations as they adapt to the external environment. To manage integration and differentiation, organizations need to continuously scan their environment, both internally and externally, in order to best determine the following: the overall tasks and corresponding functional sub-tasks to be accomplished; the resource constraints placed on the organization; the extent of coordination that is needed within the organization in order to make effective and efficient decisions across all tasks and functional sub-tasks; whether accomplishment of new tasks or sub-tasks requires sufficiently unique skills, equipment, activities or management; whether the organization requires creation of a new sub-organization, or should or could be subsumed under an existing functional sub-organization; and the most effective and efficient overall organizational design needed to accomplish those tasks and, most important, to ensure the organization can rapidly adapt to future changes within and across the identified functional areas.

(1) Integration. The environments within which the Army competes require one primary output: mission-ready forces with a full range of operational capabilities. The Army is successful only to the extent that it produces such forces. The widely diverse operational environments also require a high degree of differentiation if the Army is to meet its full-spectrum requirements. These two environmental demands—output and high differentiation—must be reconciled, and the Army must integrate many elements to produce mission-ready forces. One should expect that the greater the degree of differentiation in an organization, the more difficult it is to get the necessary coordination and integration. Generally, there are three approaches to integrating diverse organizational activities ranging from the simple to the highly complex: standard rules and procedures; plans, directives, and orders; and active management and directed integration. The use of each of these devices depends on a wide range of situational factors. Each of these devices is operating in any Army organization to some extent, and effective and complex organizations facing dynamic and diverse environments will use all of these integrative processes simultaneously.

(a) The simplest devices that can be used to deal with more certain environments are standard rules and procedures. In these cases, integration is achieved through adherence by the sub-organizations to the specified rules and procedures and active management is normally not required.

(b) Somewhat more complex devices are plans, directives and orders. In these cases, integration is achieved through formulated guidance that specifies for the overall mission each organization's roles, responsibilities, and sub-tasks in time, space and purpose. Coordination and integration is achieved through the coherency of the planning concept and the sub-organization's compliance to both the letter and intent of the plan.

(c) The most complex device is the process of active management and directed integration leading to mutual adjustment in which iterative communication is required within the management hierarchy or chain of command, and which could also entail the formation and use of cross-functional teams or individual integrators. A good example of the last process is the battalion task force approach to integrating and maneuvering the combined arms team after contact with the enemy. A project management organization also exemplifies integration by mutual adjustment.

(2) Differentiation. Organizations should be tailored in design to meet specific mission requirements and avoid unnecessary redundancy. For example, to demonstrate a forward presence in an area of vital interest to U.S. security, such as Europe, and to enhance relations with our allies, the Army has organized U.S. Army, Europe (USAREUR). Conversely, the U. S. Army Recruiting Command (USAREC), which is a major subordinate command of the U.S. Training and Doctrine Command (TRADOC), was established to deal with the Soldier acquisition task. To accommodate these different demands, the Army's systemic organizational response must be different. USAREUR would be as ineffective recruiting in the continental United States (CONUS) as USAREC would be in dealing with the Army's mission in Europe.

(a) Task or functional specialization is both a dimension and a requirement of the structure of Army organizations. Such functions as personnel management; resource management (e.g., funds and manpower); operations, intelligence and security; logistics; and research and development are found separately identified in both the management staffs and subordinate commands.

(b) A major result of task specialization is that organizations tend to be designed and structured to fit the requirements of their sub-environments. Depending on the demands of the environment, organizations in one functional specialty tend to be differentiated from organizations in other specialties in the following manner: unique functionally-related mission focus; orientation on time and results (e.g.,



short-term, mid-term, long-term); degree of formality of the structure of organizations (e.g., rules, job descriptions, chain of command, process or procedural adherence); interpersonal orientation and ways of dealing with people (e.g., mission-oriented vs. relationship-oriented), etc.

## Section II The Production Subsystem

### 4-3. Statutory Requirements

The Army's mission is to fight and win our Nation's wars by providing prompt, sustained land dominance across the full range of military operations in support of the CCDR. We do this through the following processes: executing Title 10 and Title 32 USC directives, to include organizing, equipping, and training forces for the conduct of prompt and sustained combat operations on land; accomplishing missions assigned by the President of the United States (POTUS), Secretary of Defense (SECDEF) and CCDRs; and changing the force to meet current and future demands.

### 4-4. Production of Needed Resources

The production subsystem is the cornerstone of the process. This subsystem secures resources and raw materials for its many production efforts, to include the following: recruiting untrained personnel; searching for useable technology; and dealing with producers of outside goods and services. Its task, accomplished through its people and structure, is to convert the raw materials into the intermediate goods required by the combat system. To do this, the Army integrates Doctrine, Organization, Training, Materiel, Leadership and Education, Personnel, Facilities, and Policy (DOTMLPF-P) to produce the desired end state. Training centers and schools transform untrained people into tank crewmen, infantrymen, and mechanics. Schools convert ideas and knowledge into doctrine, tactics, techniques, and training methods for the use of the combat subsystem. Laboratories, arsenals, and procurement and test organizations convert technology and contractor effort into weapons systems and equipment for the combat subsystem. Other parts of the production subsystem provide such sustaining support to the whole organizational system as health care, commissary support, and other services. The production subsystem serves primarily to meet the needs of the combat subsystem.

#### a. TRADOC.

(1) TRADOC is the first of two major components of the production subsystem. TRADOC's roles include: develop, educate and train Soldiers, civilians, and leaders; support unit training; and design, build and integrate a versatile mix of capabilities, formations, and equipment to strengthen the U.S. Army as America's force of decisive action. TRADOC is an Army Command (ACOM) consisting of HQ TRADOC, four Deputy Commanding Generals (DCGs) (responsible for leading the execution of 13 core functions), nine subordinate organizations (performing specialized functions), eight CoEs, and two reserve component (RC) DCGs.

(2) TRADOC operates 32 Army schools most organized under the eight Centers of Excellence (CoE), each focused on a separate area of expertise within the Army (e.g., Maneuver, Signal, etc.).

(3) The HQ TRADOC staff consists of a command group, personal staff, coordinating staff, special staff, and Field Operating Activities.

(4) The HQ TRADOC staff provides staff management, facilitates external coordination, and assists the Deputy Commanding General/Chief of Staff (DCG/CofS) in the prioritization of resources. It ensures the coordination and integration of DOTMLPF-P initiatives and functions between external commands and organizations and the TRADOC major subordinate centers and commands and special activities. The HQ, TRADOC staff is the primary interface with external agencies (e.g., DOD, Headquarters, Department of the Army (HQDA), joint organizations, other services, and other external agencies and organizations) to provide related Army positions and receive taskings and requests for TRADOC-related Army support.

(5) TRADOC's major subordinate centers, field operating activities and commands are also functionally aligned. Subordinate organizations that perform specialized functions and report directly to HQ TRADOC are:

(a) Army Capabilities Integration Center (ARCIC). ARCIC is a TRADOC Field Operating Activity that supports the CG, TRADOC and serves as principal advisor to the CG and TRADOC's command group in the exercise of the CG's responsibilities to design, develop, and integrate all aspects of the force into the joint force, from concept development, to force structure, to capabilities development and integration. As

## HOW THE ARMY RUNS

part of TRADOC's coordinating staff, ARCIC conducts staff management and develops and reviews policy and guidance for its core functions of concept development, requirements (capabilities) determination, and capabilities integration. ARCIC is the supported organization for the development and integration of force capabilities in collaboration with force modernization proponents across the DOTMLPF-P for the Army. ARCIC executes its mission within a unified action partners environment to support the joint force commander in accordance with ARCIC's assigned responsibilities.

(b) Combined Arms Center (CAC). CAC designs, integrates and implements leader development and the Army Leader Development Program; synchronizes and delivers education; synchronizes branch and warfighting function proponent's doctrine, training, and leadership and education integration; develops and integrates doctrine; collects, analyzes, and disseminates Army lessons learned; manages the Army training support system enterprise; manages the Army training and education development enterprise and manages the Army combat training center program to build adaptive, innovative and agile Soldiers, leaders and units in order to dominate and win in the conduct of unified land operations.

(c) Combined Arms Support Command (CASCOM) and Sustainment Center of Excellence (SCoE). The CG CASCOM is dual-hatted as the CG SCoE and provides oversight to all schools within the SCoE and directs consolidated support functions through its staff, for consolidated training development and consolidated capability development. The CG CASCOM/SCoE reports to the TRADOC DGC/CoS and trains, educates and grows adaptive sustainment professionals; develops and integrates innovative Army and Joint sustainment capabilities, concepts and doctrine to enable unified land operations.

(d) U.S. Army Center for Initial Military Training (CIMT). CIMT leads, trains and mentors civilian volunteers and enables their development of knowledge, skills, abilities, and attributes into Soldiers who are competent in military skills, individuals of character, and committed to honorably serving our Nation. CIMT establishes standards and oversees training in core competencies; and developing trusted Soldiers/leaders who are grounded in the Army Ethic and are physically, mentally, and socially ready to assume duties in their first unit of assignment.

(e) U.S. Army Cadet Command (USACC). USACC partners with universities to recruit, educate, develop, and inspire Senior ROTC Cadets in order to commission officers of character for the Total Army; and partners with high schools to conduct Junior ROTC in order to develop citizens of character for a lifetime of commitment and service to our Nation.

(f) USAREC. USAREC is responsible for recruiting America's best volunteers to enable the Army to win in a complex world.

(g) U.S. Army Asymmetric Warfare Group (AWG). The AWG provides global operational advisory support and rapid solution development to defeat current and emerging threats while informing future force combat effectiveness.

(h) U.S. Army TRADOC Analysis Center (TRAC). TRAC provides relevant, credible analysis to inform decisions about the Army's most important and challenging issues. TRAC serves as the principal analytical organization of TRADOC, while independent of TRADOC proponents. TRAC provides centralized leadership and management of analysis for capability and doctrinal developments.

(i) U.S. Army Rapid Equipping Force (REF). The REF harnesses current and emerging technologies to provide immediate solutions to urgent challenges of U.S. Army forces deployed globally. Equips operational forces with solutions to reduce operational capability shortfalls; increases Soldier safety and reduce risk; inserts future force technologies, threshold capabilities and/or surrogates into operational forces to speed development and validate concepts in an operational environment.

b. Army Materiel Command (AMC). The second major component of the production subsystem is AMC. AMC is the Army's premier provider of materiel readiness—technology, acquisition support, materiel development, logistics power projection, and sustainment—to the total force, across the full spectrum of military operations. If a Soldier shoots it, drives it, flies it, wears it, eats it or communicates with it, AMC provides it.

(1) AMC operates the following organizations: research, development and engineering centers; Army Research Laboratory (ARL); depots; arsenals; ammunition plants; and other facilities. AMC also maintains the Army Pre-Positioned Stocks (APS), both on land and afloat. The command is also the DOD Executive Agent for the chemical weapons stockpile and for conventional ammunition.

(2) To develop, buy and maintain materiel for the Army, AMC works closely with Program Executive Officers (PEO), the Army Acquisition Executive (AAE), industry and academia, the other services, and Other Government Agencies (OGA). AMC handles the majority of the Army's contracting including contracting services for deployed units and installation-level services, supplies and common-use

information technology hardware and software.

(3) AMC's main effort is to achieve the development, support, and sustainment of the current and future force. AMC is the key to supporting, sustaining and resetting the current force. Its maintenance depots and arsenals restore weapon systems. The command's overhaul and modernization efforts enhance and upgrade major weapon systems—not just making them like new, but inserting technology to make them more operationally effective and reliable.

(4) AMC handles diverse missions that reach far beyond the Army. For example, AMC manages the multi-billion dollar business of selling Army equipment and services to friends and allies of the U.S. and negotiates and implements agreement for co-production of U.S. weapons systems by foreign nations. AMC also provides numerous acquisition and logistics services to the other components of DOD and many OGA.

(5) Continuing support across the full spectrum of operations plays a large role in maintaining combat readiness. No other Army organization is faced with such diversity and myriad cross-functional activities. Consequently, AMC is continuously adjusting its organizations to adapt to the changing operational and strategic environments, while ensuring both integration and differentiation of its subordinate organizations' roles, responsibilities and functions. AMC's Major Subordinate Commands (MSCs) include, but are not limited to the following— (a) Research, Development, and Engineering Command (RDECOM). RDECOM is concerned with Research and Development (R&D) activities and missions.

(a) Research, Development, and Engineering Command (RDECOM). RDECOM manages a strategic portfolio that balances the development of technology-enabled solutions for the current fight with investments in future capabilities that are designed to give the army a competitive advantage. They address high-priority technology challenges by performing research, development, and engineering too risky or too Army-specific for industry or academia.

(b) Army Sustainment Command (ASC). ASC functions to accomplish the following: manage APS; administer the Logistics Civil Augmentation Program (LOGCAP) and Logistics Assistance Program (LAP), oversee the timely retrograde of war materiel from the theater to Army depots for reset; and support Army operations in strategic locations around the world through seven assigned deployable Army Field Support Brigades (AFSB).

(c) Joint Munitions Command (JMC). JMC provides the conventional ammunition life-cycle functions of logistics sustainment, readiness and acquisition support for all U.S. military services, OGA, and allied nations as directed.

(d) U.S. Army Security Assistance Command (USASAC). USASAC is concerned with security assistance programs to include Foreign Military Sales (FMS).

(e) Army Contracting Command (ACC). ACC provides worldwide contracting support to the war fighter by acquiring equipment, supplies and services vital to our Soldiers' mission and well-being.

(6) The AMC also coordinates directly with the Military Surface Deployment and Distribution Command (SDDC), concerned with ground transportation and port operations. The SDDC's Combatant Command (CCMD) is U.S. Transportation Command (USTRANSCOM) and serves as its ASCC. Concurrently, SDDC is also aligned as an MSC of AMC.

(7) AMC's four Life Cycle Management Commands (LCMC)—Aviation and Missile Command (AMCOM) LCMC, Communications-Electronics Command (CECOM) LCMC, Joint Munitions Command/Joint Munitions and Lethality Life Cycle Management Command (JMC/JM&L), and Tank-Automotive and Armaments Command (TACOM) LCMC—are commodity-oriented and perform life-cycle management over the initial and follow-on procurement and materiel readiness functions for items and weapon systems in support of the Army in the field (see Chap 11 for more detail on LCMCs).

(8) AMC is headquartered at Redstone Arsenal, Alabama, and impacts or has a presence in all 50 states and 150 countries. Manning these organizations is a work force of more than 60,000 dedicated military and civilian employees, many with highly developed specialties in weapons development, manufacturing and logistics.

c. Installation Operations. Key to the production subsystem is the growing central role of Army installations. The subparagraphs below provide a general discussion and background for installations operations.

(1) The integration of installation organization and operations into the Army's overall organizational structure in the 1980s, both as a home station and training base, has proven to have a significant and positive effect on readiness. Installations are organized for and capable of training, mobilizing, deploying, sustaining, supporting, recovering, and reconstituting assigned and mobilized operating forces.

## HOW THE ARMY RUNS

Additionally, activities on the installation receive installation support in accomplishing their missions. Examples of these activities are schools, hospitals, Reserve Component (RC) elements, and tactical HQ and their subordinate units. However, the traditional boundary between tactical and sustaining base activities are disappearing as the installation power projection platforms assume an increasing role in the sustainment, support, and welfare of deploying operating forces. This is also occurring because Information Technology (IT), rapid transportation, and improved management techniques are enabling more consolidated installation activities and reach-back to the installations for deployed forces.

(2) On 24 October 2006, the Army reorganized its structure for managing installations with the activation of U.S. Army Installation Management Command (IMCOM). The Army established IMCOM to reduce bureaucracy, apply a uniform business structure to manage U.S. Army installations, sustain the environment, and enhance the well-being of the military community. IMCOM's mission is to synchronize, integrate, and deliver installation services and sustain facilities in support of senior commanders in order to enable a ready and resilient Army.

(3) IMCOM transformed the Army's installation management structure into an integrated command Structure and it continues to mature its organization. On Nov. 1, 2016, IMCOM established three functionally-aligned directorates, co-located with Forces Command (IMCOM-Readiness), Training and Doctrine Command (IMCOM-Training), and Army Material Command (IMCOM-Sustainment). The directorates will be more efficient and improve mission command through unity of purpose, a smaller number of garrisons to manage, and similar demographics of communities. The directorates will solve functional challenges for garrison commanders, coordinate IMCOM HQ support, and drive/assess garrison execution of service delivery.

(4) As a DRU, IMCOM is accountable to the CSA for effective installation management in the following areas: construction; barracks and family housing; family care; food management; environmental programs; well-being; Soldier and family morale, welfare and recreation programs; logistics; public works; and installation funding. This evolution of the installation's role in the Army structure and its placement in the Army's organization has established it as a critical production subsystem of the Army.

#### d. Functional Commands.

(1) Not only is the installation operations task common to both the combat and production subsystems, but parts of the installation operations function have become recognizable specialty commands—and therefore part of the production subsystem—providing their goods and services usually to both the combat and production subsystems. For example, U. S. Army Medical Command (USMEDCOM) operates most Army medical activities in CONUS; and the U. S. Army Criminal Investigation Command (USACIDC) directs all criminal investigators.

(2) The principal reason for the establishment and continuation of functional commands is that the required degree of integration for their specialty activities differs substantially from those functions that are the responsibility of the installation commander. Each of the specialty functions is a goods or service provider that performs very different missions than those of the installation, whether it is force readiness or training. Mission performance does not require that telephone service, or commissary operations, or medical care delivery is totally integrated with facilities or maintenance so that unit readiness or training objectives can be met. The same is not true of functions like maintenance or personnel support, which more directly affect installation goal achievement.

(3) Further, the conceptual model would suggest that achieving greater efficiency on the delivery or performance of these functions could best be accomplished by improving the degree of corresponding organizational differentiation. The functional organizational model appears to do just that. The central control reinforces the commitment by the local agency to do the following: high quality, efficient telephone service and medical care; good commissary support; meeting recruiting objectives; and carrying out engineer construction projects. The process is successful because it emphasizes the uniqueness of the function and provides associated specialty career paths for employees.

e. HQDA Support Specialty Commands. Another secondary category of organizations within the production subsystem is the group of service producing, special-purpose organizations reporting to HQDA. This category includes, among others, Human Resources Command (HRC). It has tasks that do not require field units to produce the service, and therefore does not fall into the functional command category. HRC's services are used by the production and combat subsystems, as well as HQDA. Because of its specialty tasks, such agencies are directly linked to the HQDA staff, yet they are not classified as extensions to the staff because their functions are operational rather than policy generation. Most organizations operating in such manner are categorized as FOAs or DRUs. On the other hand, a

Staff Support Agency (SSA) directly supports only an Army staff principal, usually with management information, analysis, or command and control support (Note: there are no SSAs currently designated).

(1) A FOA is an agency with the primary mission of executing policy that is under the supervision of HQDA, but not an ACOM, ASCC or DRU. Listed below are the FOAs under the staff principal they support—

(a) Assistant Secretary of the Army (Manpower & Reserve Affairs) (ASA(M&RA)): U.S. Army Diversity and Leadership; U.S. Army Manpower Analysis Agency (USAMAA); Army Review Boards Agency (ARBA); Army Marketing & Research Group (AMRG).

(b) The Army Auditor General—U.S. Army Audit Agency (USAAA).

(c) Chief, Public Affairs: U.S. Army Public Affairs Center (APAC); U.S. Army Field Band.

(d) Administrative Assistant to the SECARMY (AASA): U.S. Army Headquarters Services (AHS); U.S. Army Center of Military History (CMH).

(e) The Inspector General (TIG)—U.S. Army Inspector General Agency (USAIGA).

(f) Director of the Army Staff (DAS)—U.S. Army Combat Readiness Center.

(g) DCS, G-1: HRC; Civilian Training Student Education Detachment.

(h) Office of the Army G-3/5/7: U.S. Army Force Management Support Agency (USAFMSA); U.S. Army Command and Control Support Agency (USACCSA); U.S. Army Nuclear and Combating WMD Agency (USANCA).

(i) DCS, G-4—U.S. Army Logistics Innovation Agency (LIA).

(j) DCS, G-8—U.S. Center for Army Analysis (CAA).

(k) Provost Marshal General (PMG): U.S. Army Corrections Command (USACC); Defense Forensics and Biometrics Agency (DFBA).

(l) The Judge Advocate General (TJAG): U.S. Army Legal Services Agency (USALSA); The Judge Advocate General's Legal Center and School (TJAGLCS).

(2) A DRU is an Army organization comprised of one or more units with institutional or operational functions, designated by the SECARMY, providing broad general support to the Army in a normally, single, unique discipline not otherwise available elsewhere in the Army. DRUs report directly to a HQDA principal and/or ACOM and operate under the authorities established by the SECARMY. Listed below are the fifteen HQDA DRUs—

(a) Reporting to the CSA—U.S. Army Test and Evaluation Command (ATEC); U.S. Military Academy (USMA); U.S. Military District of Washington (MDW); U.S. Army War College (USAWC); and U.S. Army Installation Management Command IMCOM.

(b) Reporting to the Executive Director Army National Military Cemetery (ED, ANMC)—Arlington National Cemetery (ANC).

(c) Reporting to the ASA (M&RA)—Army Marketing and Engagement Brigade (USAMEB).

(d) Reporting to Assistant Secretary of the Army (Acquisition, Logistics, and Technology) (ASA (ALT))—U.S. Army Acquisition Support Center (USAASC).

(e) DCS, G-1: HRC; U.S. Army Civilian Human Resources Agency (CHRA); U.S. Army Human Resources Command (HRC).

(f) Reporting to Deputy Chief of Staff, G-2—U.S. Army Intelligence and Security Command (INSCOM).

(g) Reporting to The Surgeon General (TSG)—U.S. Army Medical Command (MEDCOM).

(h) Reporting to the Chief of Engineers—U.S. Army Corps of Engineers (USACE).

(i) Reporting to the Provost Marshal General—U.S. Army Criminal Investigation Command (USACIDC).

(j) Reporting to the Assistant Secretary of the Army (Financial Management and Comptroller) (ASA (FM&C))—U.S. Army Financial Management Command (USAFMCOM).

(3) Overview of differences and comparison of DRUs and FOAs:

(a) DRUs are established by DAGO signed by the SECARMY with its responsibilities contained therein. A DRU is operationally oriented. It executes vice develops policy provided by its HQDA principal. It normally has a small headquarters and may lack a robust special staff inherent in an ACOM HQ (e.g., Inspector General (IG), Equal Employment Office (EEO), etc.). A DRU may have subordinate units that perform purely operational tasks. As stipulated in its DAGO, a DRU may be designated as an Operating Agency (OA) and exercise budget authority. Typically, a DRU submits resource/program requirements to its HQDA principal for programming/budget review and subsequently executes a program/budget approved by the HQDA principal. A DRU, in collaboration with its HQDA principal, develops appropriate input regarding the use of military and civilian manpower allocated directly by the Office of the ASA(FM&C), and performs its own internal personnel management functions (e.g., requisitions, civilian

job classifications and announcements, officer and enlisted distribution plan management). A DRU's manpower and budget are not managed as a part of the HQDA Office of the Administrative Assistant (OAA). Because a DRU may perform some functions categorically defined as Management Headquarters Account (MHA) functions in DOD Directive (DODD) 5100.73, individual billets within the DRU headquarters may be classified as reportable Army MHA billets. A DRU is usually independent of OA 22, and therefore not under the management purview of the OAA.

(b) FOAs are agencies under the supervision of DA and, like a DRU, have a primary mission of executing policy. However, a FOA has relatively limited scope and responsibilities and does not operate under the authorities established by the SECARMY. FOA manpower and budget are managed as a part of the HQDA OAA. The DAS is the final approving authority for all recommendations to establish, discontinue, increase or decrease FOAs.

(4) Program Executive Offices (PEO) that fall under ASA (ALT) include—

- (a) PEO Ammunition.
- (b) PEO Intelligence, Electronic Warfare and Sensors (IEW&S).
- (c) PEO Aviation.
- (d) PEO Command, Control and Communications Tactical (C3T).
- (e) PEO Soldier.
- (f) PEO Missiles and Space.
- (g) PEO Combat Support and Combat Service Support (CS & CSS).
- (h) PEO Simulation, Training and Instrumentation (STRI).
- (i) PEO Ground Combat Systems (GCS).
- (j) PEO Enterprise Information Systems (EIS).
- (k) Joint PEO Chemical and Biological Defense (CBD).
- (l) PEO Assembled Chemical Weapons Alternatives (ACWA).

### Section III

#### The Combat Subsystem

##### 4-5. Products of the Combat Subsystem

The combat subsystem's major task is to convert the Army's intermediate products, obtained from the production subsystems, into mission-ready forces of units and organizations. Each element of its structure welds together individual Soldiers, equipment, doctrine, procedures, and training and produces combat readiness. The combat subsystem engages in a process of continued interaction with its resource environment, primarily the production and the integrating subsystems. Its task environment includes the enemy threat, the CCMDs, allied forces with whom it must deal, and, especially in peacetime, the Office of the Secretary of Defense (OSD) and Congress.

##### 4-6. The Army in the Field

a. This category of the Army's organizational structure consists of three ACOMs, including two of the commands previously addressed under the production subsystem and installation operations, and ten ASCCs.

(1) An ACOM is an Army force, designated by the SECARMY, performing multiple Army Service Title 10 functions (3013b) across multiple disciplines. Command responsibilities are those established by the SECARMY. The three ACOMs are as follows—

- (a) TRADOC, Joint Base Langley-Eustis, VA.
- (b) AMC, Huntsville, AL.
- (c) U.S. Army Forces Command (FORSCOM), Fort Bragg, NC.

(2) An ASCC is an Army force designated by the SECARMY, comprised primarily of operational organizations serving as the Army component for a CCDR. If designated by the CCDR, it serves as a Joint Forces Land Component Command (JFLCC) or a Joint Task Force (JTF). Command responsibilities are those established by the SECARMY. The ten— ASCCs are as follows—

- (a) U.S. Army Africa / Southern European Task Force (USARAF / SETAF), Vicenza, Italy.
- (b) U.S. Army, Europe (USAREUR), Wiesbaden, GE.
- (c) U.S. Army, Central (USARCEN), Shaw Air Force Base, SC.
- (d) U.S. Army North (USARNORTH), Fort Sam Houston, TX.

- (e) U.S. Army South (USARSO), Fort Sam Houston, TX.
  - (f) U.S. Army Pacific (USARPAC), Fort Shafter, HI.
  - (g) U.S. Army Special Operations Command (USASOC), Fort Bragg, NC.
  - (h) Military Surface Deployment and Distribution Command (SDDC), Scott Air Force Base, IL.
  - (i) U.S. Army Space and Missile Defense Command / Army Forces Strategic Command (USASMDC / ARSTRAT), Huntsville, AL.
  - (j) U.S. Army Cyber Command (ARCYBER), Fort Gordon, GA.
- b. In some respects, each command faces similar environments although they differ from each other in many ways. Several commands (e.g., FORSCOM, USAREUR, USARPAC, USASOC, and USARSO) have the principal task of providing mission-ready land forces—the primary output of the Army. As a result, each has developed an organizational structure reflecting its environment.

## Section IV

### The Integrating Subsystem

#### 4-7. Tasks of the Integrating Subsystem

- a. The integrating subsystem ties all of the subordinate subsystems together for the Army as a whole. Its tasks are to decide what is to be produced or accomplished by the whole system, and to see to it that the system performs as expected. It also acts as the source of funds for the subsystems, obtaining them from DOD, Office of Management and Budget (OMB), and Congress.
- b. In any large organization, the HQ has the major function to direct the accomplishment of the overall mission and the major tasks of the organization. It is the most prominent integrating device in the organization. The challenge for the integrating subsystem is one of structuring the organization to accomplish the following tasks effectively:
  - (1) Determine the nature of current and future requirements from the strategic and operational environments (e.g., from strategic guidance from the Executive Branch and Congress, social trends, joint and other service developments, new or different external and domestic threats, technological opportunities, expanded or new domains (e.g., air, cyber, space, etc.), changes in the nature and character of war, increased resource constraints, etc.).
  - (2) Chart a course for the Army that will meet the projected demands/requirements.
  - (3) Secure the necessary resources (e.g., appropriations authority and end strength authorizations) for the Army.
  - (4) Allocate resources and assign responsibilities, objectives and performance requirements to the combat and production subsystems to address current requirements and to enable changes to meet future requirements.
  - (5) Evaluate the on-going performance of the subsystems' organizations in accomplishing current requirements and in their progress towards changing in time to meet anticipated future requirements.
  - (6) Adapt and manage change, whether evolutionary or revolutionary, to meet evolving or emerging national security requirements within acceptable risk and secured resources.

#### 4-8. Integration and Differentiation

The exercise of these functions calls for both cross-functional integration and a high degree of differentiation within the HQ. Each function must relate to a similar functional group in OSD, to some extent to interested committees in Congress, and to members of the same specialist community in the combat and production subsystems. Figure 4-1 reflects the current HQDA Organization.

- a. Achieving Integration.
  - (1) Integration is achieved in a formal series of meetings at the senior staff level within the Army Secretariat (ARSEC) and the Army Staff (ARSTAF). The heads of the staff agencies, the deputy chiefs of staff themselves, have a central integrating role, serving more as a corporate management committee than as simply representatives of their own staff agencies. There are also many task forces, working groups, and committees with membership drawn from throughout the ARSEC and ARSTAF that serve as important knowledge-based integrators.

## Headquarters, Department of the Army

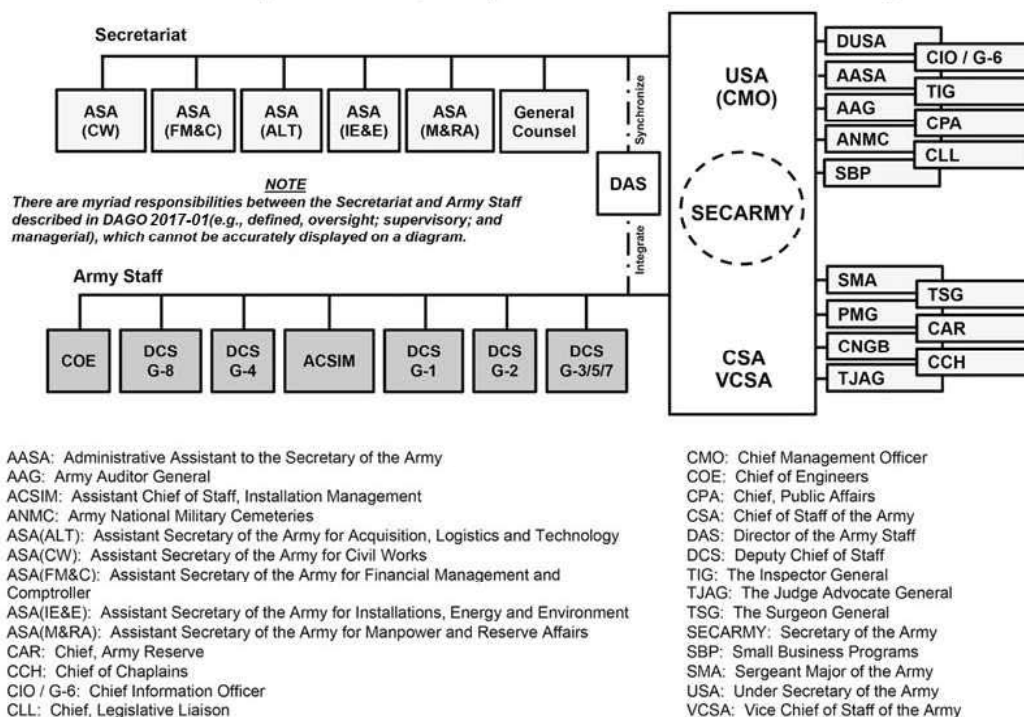

Figure 4-1. Headquarters, Department of the Army Organization

### Figure 4-1 Headquarters, Department of the Army Organization

(2) Integration is also the primary function of the Army's senior leadership, to include: the SECARMY; Under Secretary of the Army (USA); CSA; and VCSEA. This group decides on management strategies for stability, modernization of equipment, allocation of scarce resources, and force structure issues. These strategies, enunciated in the annual Army Posture Statement (APS), are unifying, integrating statements of objectives that relate directly to the dominant overall issue—maintaining mission-ready forces.

(3) The annual APS, available through the U.S. Army Home Page at <http://www.army.mil> is an unclassified summary of Army roles, missions, accomplishments, plans, and programs. Designed to reinforce the SECARMY and CSA posture and budget testimony before Congress, the APS serves a broad audience as a basic reference on the state of the Army.

b. Achieving Differentiation.

(1) Differentiation is achieved through the assignment of functional responsibilities to the HQDA directorates and the HQDA special and personal staff sections. It is within the directorates that assigned tasks such as recruiting, planning, or budgeting are managed, goals are formulated, timing coordinated, and sub-organizational hierarchy and protocols established. The directorates possess knowledge and experience sufficient for most decisions that concern their task environments.

(2) It is important at HQDA that the requirements of the associated functional environments are communicated and analyzed. This includes both upward relationships—with OSD, OMB, and congressional committee staffers—and downward relationships with the subordinate organizations. The senior leadership of the Army has a large influence on goal-setting and performance evaluation for the whole functional or specialty community within the Army and a similar influence on getting the needed resources from OSD, OMB, and Congress.

c. Horizontal Differentiation in HQDA.

(1) Part of the past debate on HQDA reorganization was the belief that the structure of HQDA actually



complicates the achievement of the required differentiation and performance. The criticism focused on the functional parts of the ARSEC and ARSTAF directorates which seemed to perform duplicate activities or have overlapping responsibilities. The *Goldwater-Nichols DOD Reorganization Act of 1986* required the integration of the two staffs into a single HQDA comprised of a Secretariat focused on managing the business of the Army and the CSA and deputy chiefs of staff responsible for planning, developing, executing, reviewing, and analyzing Army programs. The Army has continued to increase the integration of HQDA with the creation of the Executive Office of the HQDA, subsequently re-designated as Senior Leaders of the Department of the Army (SLDA), which increased administrative oversight by the DAS of both the ARSEC and ARSTAFF and required closer staff relationships.

(2) To achieve greater differentiation in acquisition management, Congress directed and placed into law that the service acquisition executive functions be placed within the service secretariats. Accordingly, the SECARMY appointed the ASA (ALT) as the AAE to centrally manage this function.

(3) The Army differentiates functions and tasks vertically. Efficiency and effectiveness demand that organizations eliminate any level that does not perform essential and unique tasks or perform critical integrating functions. The Army executes unique Title 10 functions and tasks and produces value-added outputs at the strategic, operational and tactical levels.

## Section V Summary and References

### 4-9. Summary

a. This chapter presents a theoretical construct for the organizational design and structure of the Army by looking at the Army as an open organizational system composed of a production, combat, and integrating subsystem.

b. This chapter presents the details of each subsystem's major components, organizations, roles, missions, and functions, to include the ACOMs, ASCCs, DRUs, and FOAs.

c. Additionally, this chapter examines the two defining characteristics of functional differentiation and integration.

d. Finally, and as with all complex adaptive organizations, the dynamics of the strategic and operational environments require continuous organizational change to ensure efficient differentiation between sub-organizations and effective integration of those sub-organizations' outputs. Significantly, on 9 October 2017, the Acting Secretary of the Army announced the establishment of a new command, with the intent of bringing unity of effort and command to the Army's modernization enterprise. Many of the associated modernization responsibilities are now functionally distributed and performed across the many organizations listed and described above and also in the many subsequent chapters of this senior leader reference handbook. As this 2017-2018 version goes to press, the "Conditions Setting Task Force" (CSTF) is beginning its analysis that will likely lead to substantial revisions in how the Army is organized and modernized.

### 4-10. References

- a. Army Green Book, 2016-17.
- b. 2017 Army Posture Statement, 24 Feb 2017.
- c. Army Regulation (AR) 10-5, HQDA.
- d. AR 10-87, ACOMs, ASCCs, and DRUs, 11 Dec 2017.
- e. AR 10-88, FOAs, Office of the Chief of Staff, Army.
- f. AR 570-4, Manpower Management.
- g. TRADOC Regulation (TR) 10-5, Organization and Functions
- h. DAGO 2017-01, Assignment of Functions and Responsibilities Within HQDA.
- i. DOD Reorganization Act of 1986 (Goldwater-Nichols).
- j. Joint Publication 1-02, DOD Dictionary of Military and Associated Terms.

**This page is intentionally left blank**

## Chapter 5

### Army Mobilization and Deployment

#### Section I Introduction

##### 5-1. Chapter Content

Army planning and preparation for the mobilization of Reserve Component (RC) units is perpetual, and occurs during peacetime and war. This planning is in accordance with the provisions of the Joint Operations Planning and Execution System (JOPEs) and the Army Mobilization System (AMS). Peacetime war planning informs the development of OPLANs for the conduct of operations and mobilization. This chapter covers Army mobilization, mobilization responsibilities, and industrial base process. The focus is on how the Army mobilizes forces to meet requirements of Combatant Commanders (CCDR). The chapter closes with a discussion of Department of Defense (DOD) objectives for improving industrial base preparedness in the United States to achieve national security objectives.

#### Section II Army Mobilization

##### 5-2. Framework for Army Mobilization Planning

a. Army participation in joint operations planning and Army planning for mobilization must be integrated. Joint Publication (JP) 4-05, Joint Mobilization Planning, facilitates integration of these processes by identifying the responsibilities of the Joint Staff (JS), Services, Combatant Commands (CCMD), transportation component commands, and other agencies engaged in mobilization planning. The mobilization annex of the Joint Strategic Capabilities Plan (JSCP) guides the Army and CCMDs in preparing mobilization plans. Global Force Management (GFM) is the Department of Defense Process used for aligning force assignments, apportionment and allocation processes in support of the National Defense Strategy, joint force availability requirements, and joint force assessments.

b. Army Regulation (AR) 500-5, Army Mobilization, incorporates DOD and Chairman of the Joint Chiefs of Staff (CJCS) mobilization planning guidance in a single Army publication. It recognizes the close relationship between operations planning and mobilization planning. It provides the means by which the Army accomplishes both in a coordinated manner.

c. The mobilization plans of Army commands (ACOM), Army agencies, and Army components of CCMDs, together with those of Headquarters, Department of the Army (HQDA), constitute the Army Mobilization Plan. The Army Mobilization System (AMS) is the vehicle by which all components of the Army plan and execute actions to provide and expand Army forces and resources to meet the requirements of CCMDs.

##### 5-3. Army Mobilization System Overview

a. AMS. The AMS serves as the Army supplement to the adaptive planning and execution system (APEX). It provides the interface between the Army's plans to provide forces and resources and the CCDR's plans to deploy and use them. It also provides a standard set of guidelines for developing these plans and an integrated structure for the planning products. AMS ensures that the Army plans and executes actions necessary to provide the forces and resources to meet requirements of the CCDR. It encompasses a wide range of general functions covering the full course of a military action, conflict, or war. These functions include the training, mobilization, deployment, employment, sustainment, expansion of forces beyond the approved force structure, redeployment, demobilization, and reconstitution of Army forces. The goal of AMS is to ensure the Army can adequately support all future

combat operations of the CCMD, as opposed to concentrating only on getting forces into the theater of operations. AMS is also adaptable for planning military operations in a peacetime or permissive environment. The system is not just a planning system, but also an execution system. The use of the operations plan (OPLAN) format, with functional annexes and appendices, emphasizes the operational nature of the system.

b. *Major and Functional Subsystems of AMS.* The major subsystems involved in AMS are theater force units, military manpower, and materiel. Supporting these subsystems are a number of interrelated CONUS-based functionally oriented subsystems.

(1) *Theater Force.* The theater force consists of theater force units, military manpower (e.g., personnel), and materiel apportioned for deployment to the theaters of operations. The objective of the theater force units subsystem is to ensure the orderly and timely availability of Army units for deployment as prescribed in war plans or as directed by the JS for contingency operations. It also may include new or un-resourced units that would be activated on order.

(2) *CONUS Base.* The CONUS base is an inter-connected subsystem of organizations that provide direct support to mobilization. This subsystem includes a diverse arrangement of training, logistics, and medical support assets coordinated and synchronized by U.S. Forces Command (FORSCOM) and First Army to meet post-mobilization training and readiness requirements at Mobilization Force Generation Installations (MFGI). These subsystems are shown in Figure 5-1.

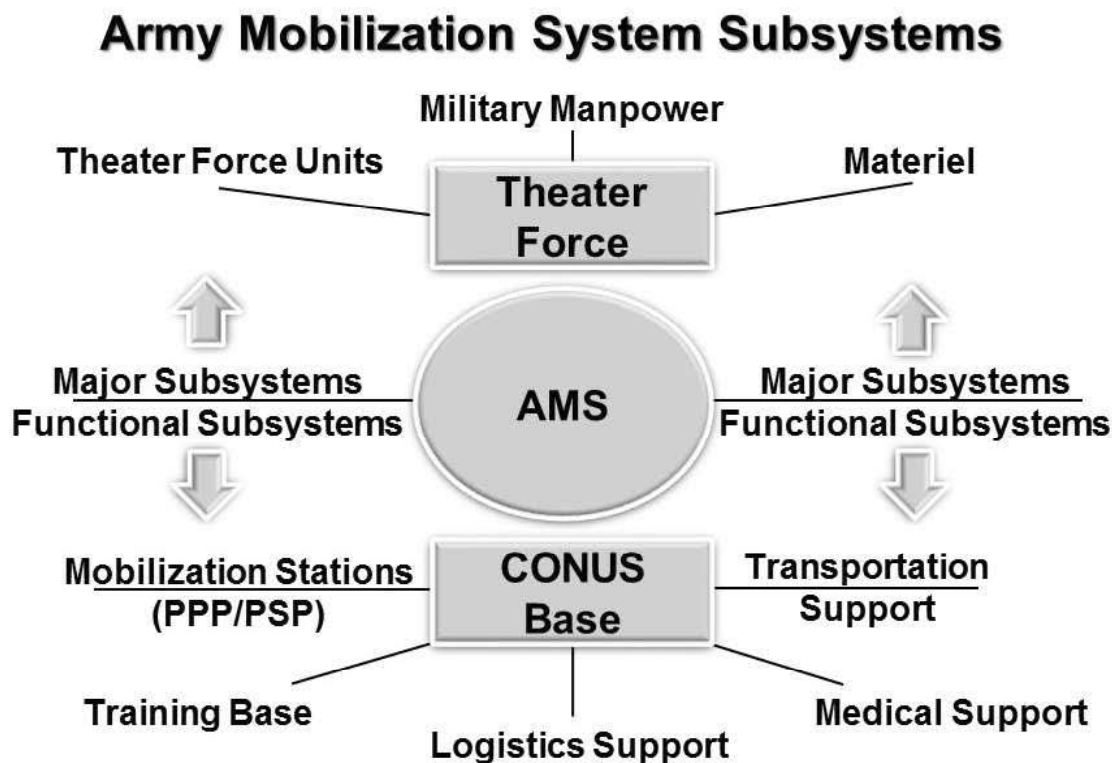

PPP: Power Projection Platforms  
 PSP: Power Support Platforms  
 CONUS: Continental United States

Figure 5-1. Army Mobilization System Subsystems

c. *Mobilization Plans.* Each of the following organizations shall prepare mobilization plans, to include considerations for deployment, redeployment, demobilization, and reconstitution actions, when appropriate. Mobilization plans shall be prepared in accordance with guidance contained in the AMS

basic plan and forwarded to HQDA for review prior to publication. Organizational mobilization plans comprise the Army Mobilization Plan, and are listed as separate volumes in AR 500-5, paragraph 3-2.

- (1) ACOMs: (FORSCOM, TRADOC, and AMC).
- (2) Army Service Component Commands (ASCC)
- (3) Direct Reporting Units (DRU)
- (4) Chief, National Guard Bureau (NGB).
- (5) Any other subordinate Army organizations HQDA or any ACOM, ASCC, or DRU directs.

d. *Mobilization Files.* Where mobilization plans are inapplicable, Army organizations shall maintain mobilization files as directed by Commander, FORSCOM or the Commanders of Eighth U.S. Army (EUSA), U.S. Army, Europe (USAREUR), U.S. Army Special Operations Command (USASOC), and U.S. Army Pacific (USARPAC). The latter commands will use FORSCOM guidance to develop mobilization files.

#### 5-4. Mobilization Planning Responsibilities

a. *DCS, G-3/5/7* will:

- (1) Develop Army mobilization and operations policy, guidance, and planning assumptions for the mobilization, deployment, employment, expansion of forces beyond the approved force structure, redeployment, demobilization, and reconstitution of Army forces. (AR 500-5)
- (2) Direct the call-up or activation of RC forces under prescribed mobilization authorities. (AR 500-5)
- (3) Coordinate with the JS and FORSCOM to provide allocation of units and resourcing prioritization for unit mobilization mission requirements to ACOMs, ASCCs, and DRUs. (AR 500-5)
- (4) Provide priority of effort and support for mobilized units as established by CCDR mission requirements. (AR 500-5)
- (5) Support and implement all mobilization process procedures and the standardized, requirements-based demobilization process. (HQDA EXORD 034-14)
- (6) Ensure regulations and policies that impact mobilization and operations are synchronized and updated to reflect current doctrine, organizational structure, and training. (HQDA EXORD 034-14)
- (7) Support the call-to and release from active duty (REFRAD) of CONUS-based, RC units and soldiers. (HQDA EXORD 034-14)

b. *Principal Department of the Army (DA) Officials and Army Staff Agencies.* Each principal DA official and agency assists the DCS, G-3/5/7 in developing and maintaining those portions of AMS that support mobilization and operational planning activities within their respective functional areas. They disseminate additional guidance to staff elements and field operating agencies (FOA) regarding the development of mobilization, deployment, redeployment, demobilization, and reconstitution plans. Additionally, Army staff agencies provide general officer (GO) or senior executive service (SES) representation at periodic general officer mobilization reviews (GOMR), colonel representation at councils of colonels (COC) Army mobilization working groups (AMWG), and action officer (AO) representation at AO mobilization working groups.

c. *Army Commands.* Each ACOM and Army component of CCMDs assist the DCS, G-3/5/7 in developing and maintaining those portions of the AMS pertaining to their respective mission areas. ACOMs are also responsible for mobilization and operations planning within their respective mission areas and for publishing a command mobilization plan as an attached volume of the Army mobilization plan. ACOMs shall submit these plans to HQDA for review and approval prior to publication. ACOMs are also responsible for compliance with the guidance and procedures published in the AMS. Specific responsibilities are as follows:

- (1) FORSCOM is the DA responsible agent and/or supported command within CONUS, minus special operations forces, for all unit mobilization, deployment, redeployment, demobilization, and reconstitution planning and execution. (AR 500-5) Additionally, FORSCOM implements all mobilization process procedures and the standardized, requirements-based demobilization process, and ensures coordination of all actions with other Army activities to improve and standardize the overall mobilization process. (HQDA EXORD 034-14) FORSCOM AMS responsibilities include: coordinating the structure and content of AMS with the Army Staff (ARSTAF), ACOMs, and other Army activities; tasking agencies and commands to prepare appropriate portions of AMS; reviewing and approving agency and command mobilization plans; ensuring AMS guidance, policies, and products satisfy applicable Office of the Secretary of Defense (OSD) and CJCS guidance, and ensuring they are updated biennially, as a minimum, but not later than 45 days after publication of the JSCP.

## HOW THE ARMY RUNS

(2) Army Materiel Command (AMC): Designates a HQDA responsible agent (Army Sustainment Command) for logistics support for unit mobilization, demobilization, and equipment reset planning and execution in coordination with DCS, G-4, and FORSCOM; conducts deliberate planning for initial stand-up and surge operations at MFGI; establishes policy and procedures and supports the deployment and redeployment of Logistics Civil Augmentation Program (LOGCAP) and non-LOGCAP contractor personnel. (AR 500-5); assists with synchronization of mobilization support and resources with FORSCOM, Installation Management Command (IMCOM), and First Army (1A); coordinates requirements and integrates supporting activities with 1A Operations Brigades through garrison. (HQDA EXORD 034-14)

(3) TRADOC is the HQDA responsible agent for development of the Mobilization Army Program for Individual Training (MOB ARPRINT), based on DCS, G-1 projections of institutional mobilization training requirements. TRADOC assists MEDCOM and U.S. Army Special Operations Command (USASOC) with command MOB ARPRINT development. As the DCS, G-1 directs, TRADOC plans for and expands the training base to provide trained manpower to support contingency operations. TRADOC coordinates with FORSCOM to ensure TRADOC-specific mobilization and demobilization requirements are achieved.

d. *Army Subordinate Component Commands*. ASCCs: assist the DCS, G-3/5/7 to develop and improve appropriate AMS imperatives within their functional and/or operational areas; exercise mission command over assigned or attached mobilized RC units; follow FORSCOM policies and procedures when developing supporting plans for the mobilization and demobilization of assigned or attached Army forces; coordinate RC unit training and exercise participation with ARNG, U.S. Army Reserve Command (USARC), FORSCOM, and appropriate ACOMs and DRUs; and provide GO or SES representation at periodic GOMRs, Colonel representation at COC AMWG, and AO representation at AO mobilization working groups. (AR 500-5)

(1) United States Army-Pacific (USARPAC) acts as the supported command for mobilization, deployment, redeployment, demobilization, and reconstitution planning and execution of conventional RC units and individuals that require Commanding General (CG), USARPAC validation for deployment and redeployment.

(2) United States Army Special Operations Command (USASOC): designates a HQDA responsible agent within CONUS for RC SOF unit alert notification, mobilization, validation, deployment, redeployment, demobilization, and reconstitution planning and execution; coordinate with ACOMs, other ASCCs, and DRUs during the mobilization process for the sustainment, training, equipping, and deployment of CONUS-based RC SOF units; provide replacement personnel and equipment to sustain RC SOF units in operational areas.

e. *Direct Reporting Units (DRU)*: Assist the DCS, G-3/5/7 to develop and improve appropriate AMS functional areas and the overall mobilization process; exercise mission command of assigned or attached RC units; follow FORSCOM policies and procedures when developing plans for the mobilization and demobilization of assigned or attached Army forces; conduct mobilization training, exercise planning, and programming activities within respective operational areas; approve mobilization plans of subordinate units and MFGI; coordinate training and exercise participation that involves RC units or individuals with ARNG, USARC, FORSCOM, and corresponding ACOMs and ASCCs; provide additional guidance and instructions to subordinate units regarding training, exercises, mobilization, deployment, redeployment, demobilization and reconstitution.

(1) IMCOM serves as the supported command for CONUS support base mobilization and demobilization, as well as the supporting command for all other mobilization requirements; coordinates mobilization capacity requirements, infrastructure, and tenant support at MFGIs; establishes and manages support base services contracts that provide IMCOM-managed installations the flexibility to acquire staff augmentation support services for non-governmental in nature (non-GIN) tasks that exceed organic capabilities, and provide contracting requirements to the U.S. Army Mission and Installation Contracting Command (MICC); annually review installation mobilization tables of distribution and allowances and assist garrisons with updates and/or changes. (AR 500-5); provide input and support of the execution of the DEMOB Validation Board in support of First Army. (HQDA EXORD 034-14)

(2) Army Medical Command (MEDCOM) serves as the supporting command for all medical services and coordinates medical support for mobilization requirements at MFGIs in coordination with FORSCOM, IMCOM, USARPAC, and U.S. Army Europe (USAREUR); establishes and manages medical support contracts to acquire staff augmentation support services that exceed organic capabilities (AR 500-5); develops mechanisms that ensure RC Soldiers complete their medical, dental, and behavioral

evaluations, and are engaged in their individual treatment programs prior to reaching day 14 of the DEMOB process. (HQDA EXORD 034-14)

f. Additional Mobilization Responsibilities.

(1) The Chief, National Guard Bureau (NGB) assists the DCS, G-3/5/7 to develop functional area specifics required to mobilize Army forces; coordinates with state, territory, and district Adjutants General, as appropriate; provide GO or SES representation at periodic GOMRs, Colonel representation at COC AMWG, and AO representation at AO mobilization working groups. (AR 500-5); supports and implements all mobilization process procedures for standardized, requirements-based mobilization and demobilization. (HQDA EXORD 034-14)

(2) The Chief, U.S. Army Reserve (OCAR) assists the DCS, G-3/5/7 to develop functional area specifics required to mobilize Army forces; coordinates with the USARC as appropriate; (AR 500-5); supports and implements all mobilization process procedures for standardized, requirements-based mobilization and demobilization. (HQDA EXORD 034-14)

(3) First Army (1A) is the supported command for CONUS-based FORSCOM mobilization and demobilization operations IAW Annex A, HQDA EXORD 034-14. 1A:

(a) Establishes requirements, integrates multiple organizations, and synchronizes resources to create unity of effort for efficient mobilization operations;

(b) ICW IMCOM, MEDCOM, AMC, USARC, ARNG, Senior Commanders, Human Resources Command (HRC) and other supporting organizations, agencies and entities, implements procedures to improve the coordination and execution of mobilization operations;

(c) 1A plans, prepares and coordinates support for training throughout the mobilization process, ICW RC components and RC deploying forces IOT develop a single integrated training plan. First Army also provides training for RC deploying forces during post-mobilization. provides command, control and validation for all deploying RC forces from Mobilization Date (MDATE) through departure from CONUS-based MFGIs for operational control to the CCDR.

(d) RC forces are attached to 1A upon arrival at the mobilization station (MOBSTA) for post-mobilization training, and remain attached for command, control, and support until deployment, and upon redeployment from theater; RC forces remain attached to 1A until effective date of demobilization/release from active duty (REFRAD).

### 5-5. Mobilization Authorities

a. Mobilization authorities are granted through Title 10 US Code (USC). The Department of Defense mobilizes all or part of the Armed Forces as authorized by law or congressional resolution and when directed by the President. Concurrently, the DOD and other federal agencies marshal national resources in order to sustain the mobilized force. (See Figure 5-2 for a complete list of RC mobilization authorizations)

b. The National Emergencies Act (1976) provides that when the POTUS declares a national emergency, the declaration or subsequent executive order must specify the authorities being invoked. The POTUS's powers are limited to those invoked until the subsequent announcement of the invoking of additional specific authorities. Once the POTUS declares a national emergency for a specific purpose, the national emergency will remain in effect for one year, unless sooner rescinded or extended.

c. The SECDEF, with the advice and recommendation of the CJCS and the Service Secretaries, recommends to the POTUS and the Congress the mobilization authority required to support a given contingency, OPLAN, or national emergency. The SECDEF directs mobilization of RC units and manpower through the military departments.

d. *Levels of Mobilization.* Generally, the extent of the emergency governs the level of mobilization.

(1) *Selective Mobilization.* For domestic emergencies or insurrection, the POTUS may order expansion of the active armed forces by activation of RC units and/or individual Soldiers to protect life and/or government property and prevent disruption of federal activities. A selective mobilization is not associated with a requirement for contingency plans involving external threats to national security.

(2) *Presidential Reserve Call-up (PRC).* The POTUS, under authority of 10 USC 12304, may augment the active forces by an involuntary call-up of units and individuals of the Selected Reserve or any member of the IRR designated as essential up to 200,000 persons from all services for up to 365 days to meet an operational requirement. No more than 30,000 of the 200,000 may be members of the IRR. The POTUS must notify Congress whenever this authority to call-up the RC is exercised.

## RC Utilization Authorities

	Legal Authority	Purpose of Duty	Applies To	Type of Duty		
<b>Training</b>	10 USC 10147	Annual Training (AT)/Drill Requirement	Reserve Only	AD/IDT	Involuntary	
	10 USC 12301(B)	Annual Training	Reserve & National Guard	AD/IDT	Involuntary	
	10 USC 12301(d)	Additional/Other Training Duty	Reserve & National Guard	AD/IDT	Voluntary	
	32 USC 502(a)	Annual Training (AT)/Drill Requirement	National Guard Only	FTNGD/IDT	Involuntary	
	32 USC 502(f)(1)(A)	Additional Training Duty	National Guard Only	FTNGD	Involuntary	
	32 USC 502(f)(1)(B)	Additional/Other Training Duty	National Guard Only	FTNGD	Voluntary	
<b>Support</b>	10 USC 12301(d)	AGR Duty/Operational Support/Additional Duty	Reserve & National Guard	AD	Voluntary	
	10 USC 12304b	Preplanned/Preprogrammed CCDR Support	Reserve & National Guard	AD	Involuntary	
	32 USC 502(f)(1)(B)	AGR Duty/Operational Support/Additional Duty	National Guard Only	FTNGD	Voluntary	
	32 USC 502(f)(1)(A)	Other Duty	National Guard Only	FTNGD	Involuntary	
<b>Mobilization</b>	10 USC 12301(a)	Full Mobilization	Reserve & National Guard	AD	Involuntary	
	10 USC 12302	Partial Mobilization	Reserve & National Guard	AD	Involuntary	
	10 USC 12304	PRC	Reserve & National Guard	AD	Involuntary	
	10 USC 12304a	Emergencies and Natural Disasters	Reserve Only	AD	Involuntary	
	14 USC 712	Emergencies and Natural Disasters	USCGR Only	AD	Involuntary	
<b>Other</b>	10 USC 12503	Funeral Honors	Reserve & National Guard	ID	Voluntary	
	32 USC 115	Funeral Honors	National Guard Only	ID	Voluntary	
	10 USC 12319	Muster Duty	Reserve & National Guard	ID	Involuntary	
	10 USC 12301(h)	Medical Care	Reserve & National Guard	AD	Voluntary	
	10 USC 12322	Medical Evaluation and Treatment	Reserve & National Guard	AD	Voluntary	
	10 USC 12323	Pending LOD for Response to Sexual Assault	Reserve & National Guard	AD	Voluntary	
	10 USC 688	Retiree Recall	Reserve & National Guard	AD	Involuntary	
	10 USC 802(d)	Disciplinary	Reserve & National Guard	AD	Involuntary	
	10 USC 10148	Unsat Participation (up to 45 days)	Reserve & National Guard	AD	Involuntary	
	10 USC 12301(g)	Captive Status	Reserve & National Guard	AD	Involuntary	
10 USC 12303	Unsat Participation (up to 24 months)	Reserve & National Guard	AD	Involuntary		
10 USC 12402	Duty at National Guard Bureau	National Guard Only	AD	Voluntary		
	10 USC 331	Insurrection	National Guard Only	AD	Involuntary	
	10 USC 332	Insurrection	National Guard Only	AD	Involuntary	
	10 USC 12406	Insurrection	National Guard Only	AD	Involuntary	

AD – Active Duty  
 CCDR – Combatant Commander  
 ID – Inactive Duty  
 IDT – Inactive Duty Training  
 FTNGD – Full Time Natl Guard Duty  
 PRC – Presidential Reserve Call-up

Table taken from DoDI 1215.06, including change 1, effective May 19, 2015

**Figure 5-2. Reserve Component Utilization Authorities**

(3) *Partial Mobilization.* In time of national emergency, declared by the POTUS, or when otherwise authorized by law (10 USC 12302), an authority designated by the service Secretary concerned may, without the consent of the persons affected, order any unit, and any member not assigned to a unit organized to serve as a unit, of a RC under the jurisdiction of that Secretary to active duty for not more than 24 consecutive months. No more than 1,000,000 members of the Ready Reserve may be on active duty, without their consent, under partial mobilization authorization at any one time.

(4) *Full Mobilization.* In time of war or national emergency declared by Congress, or when otherwise authorized by law (10 USC 12301(a)), an authority designated by the service Secretary concerned may, without the consent of the persons affected, order any unit, and any member not assigned to a unit organized to serve as a unit, of a RC under the jurisdiction of that Secretary to active duty for the duration of the war or emergency and for six months thereafter.

(5) *Total Mobilization.* Total mobilization involves expansion of the active armed forces beyond the approved force structure by organizing and/or activating additional units to respond to requirements of the emergency. All national resources, to include production facilities needed to sustain additional forces will also be mobilized. Congressional authorization is required for these actions.

(6) *Additional Authorizations: 12304a and 12304b.* The 2012 National Defense Authorization Act (NDAA) Section 12304a provides the SECDEF with the authority to order any unit, and any member not assigned to a unit organized to serve as a unit, of the USAR, Navy Reserve, Marine Corps Reserve, and Air Force Reserve to active duty without their consent for a continuous period of not more than 120 days to respond to a Governor's request for federal assistance regarding a major disaster or emergency.



Section 12304b provides the Secretary of a Military Department the authority to order any unit of the Selected Reserve, without the consent of the members, to active duty for not more than 365 consecutive days when the Secretary determines that it is necessary to augment the active forces for a preplanned mission in support of a CCMD. To exercise this authority, the manpower and associated costs of such active duty must be specifically included and identified in the defense budget materials for the fiscal year or years in which such units are anticipated to be ordered to active duty. Additionally, the budget information on such costs must include a description of the mission for which such units are anticipated to be called to active duty and the anticipated length of time involuntarily on active duty. No more than 60,000 members of the RC may be on active duty under this section at one time.

e. *Mobilization Flow.* Mobilization execution is decentralized to commands. FORSCOM and theater CCMDs are the principal commands that command and control mobilizing RC units. Other subordinate commands assume command of designated non-deploying units. Following the unit ALERT phase, and upon receipt of the unit's MOB order, RC units mobilize at home station (HS) for several days, before moving to the mobilization station (MS), which is typically one of two MFGIs within the First Army area, to train for deployment or augmentation of CONUS-based operations. Some RC units' HS is their MS. Mobilizing units at the at the MFGI work through their chains of command to cross-level personnel and equipment to reach required pre-deployment thresholds. AMC provides wholesale management for materiel. HRC serves in a similar management role for personnel. MEDCOM provides medical support services for mobilizing units. The U.S. Army Corps of Engineers (USACE), ICW IMCOM, expands troop housing, training, industrial, and other facilities as necessary. 1A oversees all required unit training and validates RC units before deployment.

### Mobilization and Execution Process

MOBILIZATION PHASE	PHASE I Pre-Mob	PHASE II Alert	PHASE III Home Station	PHASE IV Mobilization Station (MS)	PHASE V Move
PRIMARY ACTIVITY LOCATION	Home Station ▪ ARNG Armory ▪ USAR Center	Home Station ▪ ARNG Armory ▪ USAR Center	Home Station ▪ ARNG Armory ▪ USAR Center	MS (MFGI)	APOE SPOE
ACTIVITY DURATION (DAYS)	As Time Permits	3 to 7 Days	3 Days	10 to 180 Days	1 to 2 Days
PRIMARY ACTIVITY	<ul style="list-style-type: none"> <li>• MOB Planning</li> <li>• Training</li> <li>• Soldier readiness</li> </ul>	<ul style="list-style-type: none"> <li>• Recall</li> <li>• Personnel Screening</li> <li>• Records Check</li> <li>• Battle Roster</li> <li>• Cross-level personnel and equipment</li> <li>• MOB Order Prep</li> </ul>	<ul style="list-style-type: none"> <li>• Finalize Battle Roster</li> <li>• ADVON to MS</li> <li>• SRP</li> <li>• Inventory Equipment</li> <li>• Cross-level personnel &amp; equipment</li> <li>• Load for Movement</li> </ul>	<ul style="list-style-type: none"> <li>• Move to MFGI/MS</li> <li>• RSOI</li> <li>• Complete SRP</li> <li>• Conduct Training</li> <li>• Complete cross-level</li> <li>• Complete Validation</li> <li>• Load for Movement</li> </ul>	<ul style="list-style-type: none"> <li>• Move to POE</li> <li>• Load Transport</li> <li>• Deploy</li> </ul>
OUTCOME	Planning	Notification	Preparation	Validation	Deployment

ADVON: Advance Echelon  
 USAR: United States Army Reserve  
 APOE/SPOE: Air/Sea Point of Embarkation  
 MFGI: Mobilization Force Generation Installation  
 SRP: Soldier Readiness Processing

Figure 5-3. Mobilization and Execution Process

### **5-6. Department of the Army Mobilization Processing System**

The DCS, G-3/5/7 is the proponent for the Department of the Army Mobilization Processing System (DAMPS), which is a web-based system that automates the business processes of military forces mobilization and provides the workflow business process for the alert, notification and orders for Army reserve component units and individuals ordered to Active Duty. DAMPS produces and maintains unit mobilization orders. These orders provide instructions and authority for a mobilized unit to move from home station to the mob station (MS) based on the mobilization station assignments. Once the order is issued, RC commands can issue the individual MOB orders for the members of the unit. DAMPS is the cornerstone of the concept to address a fundamental need for the Army to transform reserve mobilization into an agile, information based core business process. As Army-level orders are generated, information is passed from DAMPS through intermediate commands to Army personnel systems, enabling the lashing of requirements to individual orders and enabling systems to track soldiers through the entire mobilization cycle. Data reconciled through the integration of DAMPS and other Army systems provides the basis for the Army's enterprise approach to mobilization - the Mobilization Common Operating Picture - "MOBCOP".

### **5-7 Mobilization Common Operating Picture - "MOBCOP"**

The DCS, G-3/5/7 is the proponent for the Mobilization Common Operating Picture (MOBCOP), which is a system of record comprised of an integrated enterprise collection of Authoritative Data Systems (ADS) that provides a common operating picture for functions related to mobilization of individuals and units. MOBCOP provides access to personnel and service data on RC Soldiers through fully integrated interfaces. The system automates the Army's sourcing, mobilization and tracking functions and procedures that generate and approve orders for mobilizing and deploying Army units and Soldiers.

## **Section III Industrial Preparedness**

### **5-8. The Need for Industrial Preparedness**

In the post-Cold War era when global conflicts between nation states are unlikely, the U.S. must maintain a viable industrial base that can replenish expenditures of critical war materiel following regional conflicts, or military operations in a peacetime or permissible environment, in a timely manner. Most future conflicts will be "come as you are" actions. The industrial base may be called upon to both sustain deployed forces and to expeditiously replace losses in order to be prepared for another contingency.

### **5-9. Department of Defense Industrial Base Policy Objectives**

a. From the 2011 Annual Industrial Capabilities Report to Congress: "During the past decade the Department relied on market forces to create, shape, and sustain the industrial, manufacturing, and technological capabilities in the industrial base intervening only when absolutely necessary to sustain essential defense capabilities. As the wars in Iraq and Afghanistan continue to evolve, and our nation continues to recover from the worst economic recession since the Great Depression, the Department faces significantly greater constraints on resources. These constraints will have significant impacts on the defense industrial base. The Department must work closely with our partners in the defense industry to ensure that we are better stewards of the taxpayers' money in these fiscally austere times."

b. There are seven guideposts set forth in DOD policy:

(1) DOD will rely on normal market forces to make the most efficient adjustments to the defense industrial base. This is not only in accordance with good economic theory, but necessary to prevent the defense industry from becoming further distanced from the main currents of 21st century technology, creativity, and capital markets.

(2) Competition is one of the key drivers of productivity and value in all sectors of the economy, including defense. Accordingly, DOD is not likely to support further consolidation of our principal weapons systems prime contractors. A number of initiatives are aimed at increasing competition among all U.S. suppliers and throughout U.S. procurement of goods and services.

(3) DOD will be looking at U.S. industry sector by sector—from shipbuilding to professional services, and from stealth to space—because the dynamics are different in each sector.

(4) DOD's interest in the defense industrial base extends throughout its entire spectrum. The industrial base is not made up of only those who receive prime awards.

(5) DOD will give heightened attention to the increasing importance of the "services" component of the "goods and services" the Department requires, again provided by firms not often considered defense companies. These services are as essential as weapons systems to mission accomplishment, and we are taking a number of steps to better understand and manage this part of the Department's spend.

(6) A key part of the DOD's defense industrial strategy is to encourage new entrants. They offer competition, renew and refresh the technology base, and ensure that defense is benefitting from the main currents of emerging technology.

(7) Globalization is affecting security and commerce in profound ways, and this trend has implications for the defense industry. DOD is committed to continue opening defense markets to leading firms around the world while at the same time striking the appropriate balance with security concerns.

c. DOD is conducting a sector-by-sector, tier-by-tier analysis of the defense industrial base. This analysis aims to locate early indicators of risks to defense programs, identify cross-program interdependencies throughout the supply chain, pinpoint areas of limited competition that may drive up costs, and find areas of overreliance on foreign sources that may exist. The sector-by-sector, tier-by-tier analysis will be conducted annually to ensure that the industrial base which the Department relies upon is healthy, vibrant, and flexible to meet the Department's needs today and well into the future. This analysis will be used to influence the Department's investment decisions.

#### **5-10. Department of Defense-Level Industrial Preparedness Management**

a. It is DOD policy to maintain a state of industrial preparedness by working with private industry to produce, maintain, and repair materiel that meets mobilization requirements. Where it is determined that required mobilization items cannot be provided by the private sector, then government-owned facilities and equipment are acquired and maintained to produce them.

b. Overall responsibility for managing the defense industrial base is vested in the Deputy Assistant Secretary of Defense for Manufacturing and Industrial Base Policy (DASD (MIBP)). The mission of the office of MIBP is to ensure robust, secure, resilient, and innovative industrial capabilities upon which the DOD can rely to fulfill warfighter requirements.

c. MIBP supports the Office of the SECDEF and Service Acquisition Executives by providing detailed analyses and in-depth understanding of the increasingly global, commercial, and financially complex industrial supply chain essential to national defense, and recommending or taking appropriate actions to maintain the health, integrity and technical superiority of that supply chain. MIBP is DOD's lead in all matters relating to mergers, acquisitions, and dissolutions of national security-related business.

d. MIBP addresses innovation within supply chain sectors and supports responsible investment to advance industrial productivity through a variety of authorities and programs, including the Defense Production Act and Manufacturing Technology (ManTech). The challenges of critical and fragile elements of the base are also analyzed to identify systemic and fundamental issues that can be resolved through engagement across the public and private sectors.

#### **5-11. The Defense Priorities and Allocations System**

a. This regulatory system (15 Code of Federal Regulations (CFR) 700), administered by the Department of Commerce (DOC), is used to ensure the timely availability of industrial resources to meet approved national defense and emergency preparedness program requirements and to provide an operating system to support rapid industrial response in a national emergency.

b. The authority for this regulatory system is found in Title I of the Defense Production Act (50 USC App. 2061, et seq.), which authorizes the POTUS to require:

- (1) The priority performance of defense contracts and orders over all other contracts and orders.
- (2) The allocation of materials, services, and facilities necessary and appropriate to promote the national defense.

c. The DPAS establishes two levels of contract priority: "DX" (highest national urgency); and "DO" (critical to national defense). DX priority rated contracts and orders take precedence over DO priority rated contracts and orders; and DO rated contracts and orders take precedence over un-rated / commercial contracts and orders. The DPAS requires that—

- (1) Contractors and suppliers capable of their performance accept all priority rated contracts and orders.
- (2) Precedence is given to priority rated contracts and orders as necessary to achieve timely delivery.

## HOW THE ARMY RUNS

(3) Contractors extend the priority rating to contracts and orders placed with their vendors and suppliers.

d. Although the DPAS is self-executing, in the event of a problem involving acceptance, scheduling, production, or any situation that would interfere with timely delivery of a priority rated contract or order, special priorities assistance may be requested. DOC may take official action under the DPAS to resolve the problem.

### 5-12. The National Defense Stockpile

a. The Strategic and Critical Materials Stock Piling Act (50 U.S.C. § 98 et seq.) provides for the acquisition and retention of stocks of certain strategic and critical materials and encourages the conservation and development of sources of such materials within the United States. The acquisition and retention of stocks will decrease and preclude, when possible, a dangerous and costly dependence upon foreign sources or a single point of failure of such materials during and immediately following a national emergency. Such materials when acquired and stored constitute and are collectively known as the National Defense Stockpile (NDS or the “stockpile”).

b. By Executive Order, the Secretary of Defense is designated as the NDS Manager, with management responsibilities delegated to the Under Secretary of Defense for Acquisition, Technology and Logistics. The operational activities of the NDS are delegated to the Director of the Defense Logistics Agency (DLA). DLA Strategic Materials was established as a field activity to manage the operations of the NDS program, including the acquisition, storage, management, and disposal of materials.

### 5-13. Department of Defense Key Facilities List

Key Facilities List (KFL) is a list of facilities of such importance that loss through sabotage, subversion, terrorism, or other hostile acts would seriously impair the national defense posture of the United States. FORSCOM uses the KFL in fulfilling its responsibility for CONUS land defense planning.

### 5-14. Army Industrial Base Process

The DOD-level management philosophy applies to the Army's Industrial Base Process outlined in Army Regulation 700-90 (updated 27 Jan 2014):

a. Overarching industrial base strategy.

(1) In the acquisition of materiel, the Army should employ life cycle strategies that effectively use market research of worldwide capabilities and capacities to achieve a responsive, innovative and efficient industrial base.

(2) Recognize the inherent advantages of competition and commercial capability and capacity to meet the Army's materiel needs to the maximum extent practicable. Establish organic core depot-level maintenance and repair capacity as an essential component to meet national defense requirements. Focus organic industrial capability on mitigating the risk associated with reliance on private sector capacity. An essential nucleus of organic capacity will be established and sustained in compliance with statutory mandates and readiness requirements.

(3) Use public-private partnering (PPP), as permitted by statutes, when appropriate to ensure a healthy, capable and efficient industrial base.

(4) Provide a comprehensive and continuous program for the future safety and for the defense of the United States by providing adequate measures whereby the private sector and an essential nucleus of Government-owned industrial activities and depots can supply the needs of the armed forces in time of national emergency. This essential nucleus is mandated by several statutes, most notably Section 2535, Title 10, U.S. Code (10 USC 2535), that states the intent of Congress to maintain a comprehensive and continuous program to provide for such defense measures. The statute establishes that to the maximum extent practicable, reliance will be placed upon private industry for support of defense production, yet it is necessary to maintain industrial manufacturing capability for production of critical items to provide production capacity not available in private industry or to assist private industry in time of national disaster

b. Management tools available include the following:

(1) *Industrial Preparedness Planning (IPP)*. IPP is conducted to ensure that an adequate industrial base is established, maintained, and retained to be responsive to military materiel requirements in the event of an emergency. It involves the assessment of the capability of the industrial base to support peacetime and emergency operations, and planning with industry to ensure adequate procurement, production, and maintenance capabilities to meet support requirements.

(2) *DA Critical Items List (DACIL)*. The DACIL is prepared by the DCS, G-3/5/7. They provide biennially a priority list of items required to sustain warfighting for either an indefinite or surge contingency. They also provide stable mobilization requirements to support planning with industry. The DACIL are the basic documents from which IPP is conducted.

(3) *Industrial Preparedness Planning List (IPPL)*. Prepared by AMC from the DACIL, the IPPL consists of critical items having long lead-time components. Many of these components require special manufacturing skills or present other production challenges requiring detailed planning.

(4) *Industrial Capability Assessment (ICA)*. When market research reveals a problem with supplying Warfighter's needs, an ICA will be accomplished. This assessment will address both public and private sources. The Assistant Secretary of the Army (Acquisition, Logistics and Technology) provides programming guidance to PEOs and/or PMs and item managers for ICAs based on priorities validated by DCS, G-3/5/7 and DCS, G-4. The PEOs and/or PMs and item managers will base their budget and program objective memorandum (POM) submissions to Deputy Chief of Staff, G-8 (DCS, G-8) on this guidance and the industrial base ability to successfully execute.

(5) *Industrial Preparedness Measures (IPM)*. These actions aid industry to overcome production deficiencies in the Army's industrial base. IPMs are designed to shorten production lead-time, increase production or repair capacity, and reduce inspection time. IPMs for accelerated production will only be used when they are cost-effective alternatives to stockpiling.

## Section IV Summary and References

### 5-15. Summary

The utility of the Army to the nation depends on whether its forces can be rapidly and effectively mobilized, deployed, employed, and sustained. The process of planning for contingencies or for emergencies is a continuous, all-encompassing process. It incorporates all aspects of Army management including manpower procurement, training, materiel development, and fiscal assets and constraints. Central to the task of reinforcing active forces is the ability to mobilize RC assets and to deploy them with the least possible delay.

### 5-16. References

- a. AR 500-5, Army Mobilization, 16 Apr 2016.
- b. AR 700-90, Army Industrial Base Process, 27 Jan 2014.
- c. CJCS Manual (CJCSM) 3122.01, Joint Operation Planning and Execution System (JOPES), Vol I, (Planning Policies and Procedures), 2 Jul 2010.
- d. DOD Directive (DODD) 4400.01E, SUBJECT: Defense Production Act Programs, 14 Sep 2007.
- e. DODD 1215.06, Uniform Reserve, Training and Retirement Categories for the Reserve Components, Change 1 effective May 19, 2015.
- f. FORSCOM Regulation 55-1, Unit Movement Planning, 14 Jun 2016.
- g. FORSCOM Regulation 500-3-1, FORSCOM Mobilization Plan, 20 Aug 2007.
- h. HQDA EXORD 034-14.
- i. U.S. Department of Commerce, Defense Priorities and Allocations System (DPAS) Regulation (CFR, Title 15, Chapter VII, Part 700), 2009.
- j. U.S. DOD, DOD Annual Industrial Capabilities Report to Congress, Aug 2011.

**This page is intentionally left blank**

## Chapter 6

### Reserve Components

#### Section I Introduction

##### 6-1. Chapter Content

This chapter addresses the role, organization, structure, and contributions of the Reserve Components (RC) of the Army.

##### 6-2. Reserve Components

There are seven federal RC in the Department of Defense (DOD): U.S. Army Reserve (USAR); U.S. Air Force Reserve (USAFR); U.S. Navy Reserve (USNR); U.S. Marine Corps Forces Reserve (MARFORRES); U. S. Coast Guard Reserve (USCGR); Army National Guard (ARNG); and the Air National Guard (ANG). The USCGR, although a naval force, belongs to the Department of Homeland Security (DHS) in time of peace, just like the active Coast Guard. Upon declaration of war, or when directed by the President of the U.S. (POTUS), the Coast Guard reverts to the Department of the Navy. In their DHS role, the Coast Guard can and does participate in law enforcement.

##### 6-3. Reserve Components Statutory Foundation

Section 10102 of Title 10, United States Code (USC), identifies the RC purpose as follows: to provide trained units and qualified persons available for active duty in time of war, national emergency, or as national security requires. Chapter 1003, Title 10, USC, identifies the ARNG and USAR as the RC of the Army. Legal provisions specific to the ARNG are in Title 32, USC.

##### 6-4. Reserve Components Chain of Command

In many ways, the ARNG and ANG are very similar to the USAR and USAFR. The primary difference lies with the level of government in which they fall. The USAR and USAFR are subordinate to the federal government while the state National Guard units are subordinate to the various state or territorial governments, except when called into federal service by the POTUS, or as provided for by law.

##### 6-5. Reserve Components Force Structure Mix, Roles, and Size

a. The RC provides operational capabilities and strategic depth to meet U.S. defense requirements across the full range of military operations. Over half of the Army's total deployable forces are in the ARNG and USAR. The Army's principal force management goal is to meet the requirements of the defense strategy at the least risk to the nation's security and Soldiers. By law, the Army's force mix will comprise capabilities and capacity from the Regular Army (RA), ARNG, and USAR.

b. In general terms, the Active Component (AC) is best suited for emergent and frequent deployments and dealing with complex operational environments and unexpected contingencies. The RC is best suited for predictable and infrequent deployments and providing Title 32 support to state and local authorities, as well as operational and strategic depth. The Army trains and employs its RC as part of the Army's total force to support the nation in defense support to civil authorities (DSCA) and support to the regional combatant commanders (CCDR) through planned, predictable, and programmed rotational cycles.

c. Ideally, the Army AC forces are sized and organized to accomplish the following: provide the large majority of forces to conduct early deploying contingency operations; sustain service day-to-day enduring forward presence, training, readiness, and generating force requirements; provide sufficient capacity for complex, critical, and/or multipurpose capabilities whose readiness cannot be quickly replicated by RC units; and provide rotationally available forces to meet less predictable requirements.

d. The Army RC Forces are sized and organized to accomplish the following: provide select immediate response forces when limitations on the size of the AC require acceptance of some level of risk; supplement and/or complement early deploying AC forces across a full range of military operations; provide rotationally available forces to meet more predictable requirements; provide follow on forces to allow AC forces to regenerate readiness and prepare for next mission; and provide forces and units for CONUS disaster response. The RCs are best able to leverage civilian acquired skills – those skills, often of a technical nature, that would be too onerous to demand of rotating AC soldiers. These positions would include various medical specialties and those jobs needing special advanced degrees, licenses, training or certifications.

d. Common references to components (COMPO) are as follows: AC is COMPO 1; ARNG is COMPO 2; and USAR is COMPO 3.

e. Multi-COMPO Units (MCU). A MCU combines personnel and/or equipment from more than one COMPO on a single authorization document. The intent of MCU is to maximize integration of AC and RC resources. MCUs have unity of command and control (C2) similar to that of single-COMPO units.

**Section II  
Reserve Service**

**6-6. Reserve Service Categories**

There are three major categories of reserve service: the Ready Reserve; the Standby Reserve; and the Retired Reserve (see Fig 6-1).



USAR: U.S. Army Reserve  
ARNG: Army National Guard

Figure 6-1. Reserve Service Categories



### 6-7. The Ready Reserve

The Ready Reserve has three subcategories: Selected Reserve; Individual Ready Reserve (IRR); and Inactive National Guard (ING).

a. *Selected Reserve*. The Selected Reserve consists of the following: ARNG units (e.g., drilling personnel), Title 32 Active Guard/Reserve (AGR); Title 10 personnel; USAR troop program units (TPU); USAR Individual Mobilization Augmentee (IMA). IMAs and Drilling IMAs (DIMAs) are included in AC table of distribution and allowances (TDA) units and are funded by USAR funds.

b. *IRR*. The IRR consists of personnel with remaining obligations and control groups (e.g., USAR only).

(1) Human Resources Command (HRC) exercises mission command over the IRR, Standby Reserve, and Retired Reserve. For strength accountability purposes, the IRR consists of pre-trained individual Soldiers assigned to various groups for control and administration. The IRR is available for mobilization in time of war or national emergency declared by Congress or the POTUS, and a portion of the IRR is available under Presidential Reserve Call-Up (PRC) authority.

(2) The IMA program (AR 140-145) serves as a holding account in the USAR for the assignment of a limited number individual Soldiers not assigned to a regular USAR unit. Assigning Soldiers as IMAs allows these individuals to be used as augmentation or replacements for AC units without “breaking” a USAR unit to fill the need and streamlines the mobilization process. Soldiers assigned to the IMA program are volunteers who are readily and immediately available to meet individual mobilization requirements and contingency operational needs. IMA positions are identified on the AC unit’s MOBTA and are usually focused on manning requirements needed in wartime that are not present in peacetime, such as an increased number of instructors to handle an emergency influx of trainees. The IMA program also allows qualified Soldiers to continue to serve, even though they do not reside near a USAR unit.

(3) The IRR constitutes the largest category of the pre-trained individual manpower. These personnel provide the majority of filler personnel required to bring both the AC and Selected Reserve units to their wartime required personnel strength in the event of mobilization and initial casualty replacements and/or fillers in fighting theaters.

c. *ING*.

(1) The ING provides a means for individuals who are otherwise unable to participate in an active status to continue in a military status in the ARNG. While in the ING, individuals retain their federal recognition and Reserve of the Army status as members of ARNG units. Subject to immediate involuntary mobilization with their assigned units in time of federal or state emergency, personnel transferred to the ING normally are attached to their former ARNG units and are responsible to participate in an annual muster with their unit.

(2) Individuals assigned to the ING are included in the Ready Reserve strength of the Army.

### 6-8. Standby Reserve (United States Army Reserve Only)

a. The Standby Reserve consists of Soldiers who want to maintain their military affiliation without being in the Ready Reserve or Retired Reserve. Membership is limited to those Soldiers having mobilization potential, but who are not normally subject to immediate mobilization. The Standby Reserve is part of the Individual Ready Reserve (IRR).

b. The Standby Reserve is composed of an active list and an inactive list. Those assigned in an active status are authorized to participate in Ready Reserve training at no expense to the government. Such participation includes training to earn retirement points or to qualify for promotion. Individuals assigned in an inactive status are normally not authorized to participate in USAR training.

### 6-9. Retired Reserve (United States Army Reserve Only)

a. The Retired Reserve includes those individuals who: are eligible for and who have requested transfer to the Retired Reserve; are entitled to retiree pay from the armed forces because of prior military service; have completed 20 or more qualifying years of service in the RC (e.g., ARNG or USAR) and/or active service for which retirement benefits are not payable until age 60; are ARNG and/or USAR officers and warrant officers who are drawing retired pay after completing 20 or more years of active federal service; and are RA enlisted personnel retired after 20, but less than 30, years of active service until they have completed 30 years of service.

b. Members of the Retired Reserve are not provided any form of training and are not available for military service except in time of war or a congressionally declared national emergency. However,

service Secretaries may recall retired personnel with 20 or more years of active service to active duty at any time in the interest of national defense.

## Section III Reserve Components Management

### 6-10. Governance

All three COMPOs of the Army are governed by Congress and affected by recommendations of the Office of the Secretary of Defense (OSD) and Department of the Army (DA).

### 6-11. Congress

a. *Committees*. The House Armed Services Committee (HASC) and Senate Armed Services Committees (SASC) establish end strength authorizations and other matters concerning the ARNG and USAR. Establishing and approving the annual paid end strength authorizations are the most significant congressional actions. Each year, end strength ceilings are authorized to support appropriations for reserve pay and allowances. The defense subcommittees of both the House Appropriations Committee (HAC) and Senate Appropriations Committee (SAC) prepare the appropriation acts that allow funding.

b. *Uniform Services Employment and Reemployment Rights Act (USERRA)*. This congressional legislation protects RC Soldiers' rights for reemployment after military service or training. This act does not replace the Service members Civil Relief Act (SCRA), but codifies and clarifies 50 years of case law and court decisions. The USERRA entitles reserve Soldiers to return to their civilian employment with the seniority, status, and pay they would have attained had they been continuously employed. Among other protections, it expands health care and employee benefit pension plan coverage.

### 6-12. Office of the Secretary of Defense

a. *Assistant Secretary of Defense for Reserve Affairs (ASD (RA))*. ASD (RA) has overall responsibility for all RC issues at the OSD level.

b. *Reserve Forces Policy Board (RFPB)*. By Title 10, USC, 10301, the RFPB is an independent adviser to the Secretary of Defense (SECDEF) to provide advice and recommendations on strategies, policies, and practices designed to improve and enhance the capabilities, efficiency, and effectiveness of the RC. The RFPB consists of 20 members including the following: a civilian chairman; two active or Retired Reserve officers or enlisted members from each of the Army, Navy, and Air Force military departments (MILDEP); one active or Retired Reserve officer or enlisted member of the Coast Guard; 10 U.S. citizens who have significant knowledge of and experience in policy matters relevant to national security and RC matters appointed or designated by the SECDEF; a general or flag reserve officer from the Army, Navy, Air Force, or Marine Corps to serve as military adviser to the chair, as military executive officer of the board, and as supervisor of the operations and staff of the board; and a senior enlisted member of a RC to serve as enlisted military adviser to the chair. The SECDEF is formally associated with the RC community through the RFPB. The SECDEF is required by statute to submit an annual report to the POTUS and Congress prepared by the RFPB on any RC matter that the RFPB considers appropriate to include in the report.

c. *National Committee for Employer Support of the Guard and Reserve (ESGR)*. In operation since 1972, the ESGR is dedicated to improvement of relations between civilian employers and local ARNG and USAR units. The committee has successfully resolved many employer and/or employee misunderstandings arising from RC service. It operates on an informal basis with the goal of ensuring that individuals have the freedom to participate in training without employment obstacles or loss of earned vacations. In FY 1979, state chairmen were appointed to work with the national chairman. The use of state committees provides widespread support for the program.

### 6-13. Joint Chiefs of Staff

The Chief, National Guard Bureau (CNGB) is a member of the Joint Chiefs of Staff (JCS) in accordance with Title 10, USC, 151(a), as amended by the 2012 National Defense Authorization Act (NDAA). As a member of the JCS, the CNGB has specific responsibility of addressing matters involving non-federalized National Guard forces in support of DHS and DSCA missions.

**6-14. Headquarters, Department of the Army**

The Office of the Chief of the Army Reserve (OCAR) is a component of the HQDA staff. State governors are not subordinate to HQDA and control their respective ARNG units unless the unit is mobilized in federal service. Other RC management entities include:

a. *Assistant Secretary of the Army for Manpower and Reserve Affairs (ASA (M&RA))*. The ASA (M&RA) has overall responsibility for the RC.

b. *Reserve Component Coordination Council (RCCC)*. Established in 1976, the RCCC reviews progress on RC matters related to readiness improvement, examines problem areas and issues, coordinates the tasking of issues to the Army Staff (ARSTAF), and reviews staff efforts. The RCCC is chaired by the Vice, Chief of Staff, U.S. Army (VCSA), includes selected general officers from the ARSTAF, Chief of the Army Reserve, Director of the ARNG, the U.S. Forces Command (USFORSCOM) Chief of Staff, and the Deputy ASA(M&RA).

c. *Army Reserve Forces Policy Committee (ARFPC)*. The ARFPC reviews and comments to the Secretary of the Army (SECARMY) and the Chief of Staff, U.S. Army (CSA) on major policy matters directly affecting the RC and the mobilization preparedness of the Army. Membership of the committee, which is appointed by the SECARMY, consists of five AC general officers on duty with the ARSTAF, five ARNG general officers, and five USAR general officers. There are also five alternate members appointed from the ARNG and five alternate members appointed from the USAR. RC principal members are appointed for a three-year term, RC alternate members are appointed for a one-year term, and AC members are appointed for the duration of their assignment to the ARSTAF. The ASA (M&RA), ARNG, OCAR, U.S. Army Training and Doctrine Command (TRADOC), and USFORSCOM also provide liaisons. The Director of the Army Staff (DAS) serves as adviser to the ARFPC. The committee chairman is selected from the RC members and serves a two-year term. The Goldwater-Nichols DOD Reorganization Act of 1986 reassigned the committee from the office of the CSA to the office of the SECARMY. The ARFPC Chairman reports directly to the SECARMY. The act also modified the nomination procedures. The committee normally meets in March, June, September, and December.

**6-15. National Guard Bureau**

a. The NGB is a DOD joint activity and the legally designated channel of communication between the Departments of the Army and Air Force and the states, territories, and Washington, District of Columbia (DC) as established by section 10501, Title 10, USC, and DOD Directive 5105.77, NGB. The CNGB is a principal advisor to the SECDEF, through the Chairman of the Joint Chiefs of Staff (CJCS), on matters involving non-federalized National Guard forces and on other matters as determined by the SECDEF and the principal advisor to the SECARMY and the CSA, and to the Secretary of the Air Force and the Chief of Staff of the Air Force, on matters relating to the National Guard, the ARNG, and the Air National Guard of the United States in accordance with Title 10, USC, 10502, as amended by the 2008 NDAA.

b. The CNGB works directly with the State Adjutants General. Although the CNGB has no command authority in these dealings, cooperation is facilitated through control and coordination of funds, end strength, equipment, force structure programs, and by authority to develop and publish regulations pertaining to the ARNG when not federally mobilized.

c. The CNGB is appointed to a four-year term by the POTUS, with the advice and consent of the Senate.

**6-16. Office of the Chief, Army Reserve**

According to Title 10, USC, 3038, the Chief, Army Reserve (CAR) holds the grade of lieutenant general. Title 10, USC, 10171, states that the United States Army Reserve Command (USARC) is a separate command of the Army commanded by the CAR. Except as otherwise prescribed by the SECDEF, the SECARMY shall prescribe the chain of command for the USARC. Except for Outside of the Continental United States (OCONUS) units commanded by the U.S. Army, Europe (USAEUR) and U.S. Army, Pacific (USARPAC), almost all Army Reserve troop program units (TPU) are commanded by the USARC.

a. The OCAR provides direction for USAR planning to accomplish the mission of providing trained units and individuals to support Army mobilization plans. The CAR is appointed by the POTUS with the advice and consent of the Senate and holds office for four years. The CAR may succeed himself one time and holds the rank of lieutenant general for the duration of the appointment. The CAR also serves as Commanding General (CG), USARC. The duties of the CAR include—

- (1) Commander, USARC.

- (2) Adviser to the CSA on USAR matters.
- (3) Directly responsible to the CSA for matters pertaining to the development, readiness, and maintenance of the USAR.
- (4) Responsible for implementation and execution of approved USAR plans and programs.
- (5) USAR representative in relations with governmental agencies and the public.
- (6) Adviser to the ARSTAF agencies in formulating and developing DA policies affecting the USAR.
- (7) Assists in development of USAR mobilization policy and plans.
- (8) In coordination with other appropriate ARSTAF agencies, develops, recommends, establishes, and promulgates DA policy for USAR training.
- (9) Appropriation sponsor for three USAR appropriations (e.g., pay and allowances, operations and maintenance, and construction).
- (10) Member of DA and OSD committees, as required.

## 6-17. State Adjutants General (National Guard)

a. ARNG units are located in each of the 50 states, Washington, DC, Guam, Puerto Rico, and the Virgin Islands. In addition, Guam and American Samoa signed a memorandum of agreement (MOA) in 2010 whereby American Samoans are able to serve in the Guam ARNG. Command of the ARNG, when not in active federal service, is vested with the Governors of the states and territories, who exercise command through The Adjutant General (TAG). TAG is either an Army or Air National Guard officer who is appointed by the Governor in all states and territories except for Vermont, South Carolina, and Washington, DC. Vermont's TAG is elected by the state legislature, whereas South Carolina's TAG is determined by popular election, and the POTUS appoints the CG of Washington, DC. TAG is also a state official whose authority is recognized by federal law. The authorized TAG grade is normally major general.

b. TAGs and their management staffs, which include both state and federal employees, manage federal resources to build combat-ready units. Under TAG, ARNG commanders lead their combat-ready units in training during peacetime.

c. A Joint Forces Headquarters-State (JFHQ-State) is organized within each state. The JFHQ-State is responsible for the manning, equipping, and training of ARNG units during pre-mobilization. As directed by USFORSCOM and First Army and as coordinated by NGB, the JFHQ-State is responsible for providing increased levels of support to federalized units and moving federalized units to the mobilization station or port of embarkation. The JFHQ-State is also capable of providing some installation support, family support, and mobilization support to other RC units within the state upon declaration of a national emergency. The JFHQ-State continues to provide support to non-federalized ARNG units within the state. Upon mobilization, the gaining numbered Army or Combatant Command (COCOM) assumes C2 of federalized ARNG units. If the JFHQ-State is federalized for a domestic DHS mission, it will fall under the C2 of the respective geographic COCOM.

d. The U.S. Property and Fiscal Officer (USPFO) is a colonel in the ARNG or ANG ordered to active duty under the provisions of Title 10, USC, and assigned to the NGB with duty in the state supporting the state TAG. The USPFO receives and accounts for all federal funds and property, and provides financial and logistical resources for the maintenance of federal property provided to the state. The USPFO manages the Army and Air Force federal logistics support systems for the state and, upon mobilization of a supported unit, provides the support necessary for the unit to transition to active duty status. Additionally, the USPFO functions as a federal contracting officer responsible for federal procurement activities within the state. The USPFO is also responsible for certifying the accuracy of federal payrolls.

e. Title 10, USC, 1803, Facilities for RC, provides for federal support of construction of ARNG facilities. This law permits construction of facilities on sites furnished by states at no cost to the federal government or on federal property licensed to the state specifically for ARNG purposes. Funding for approved armory construction is normally 75% federal funds and 25% state funds with 100% federal support for other construction such as administrative, logistics support, and training facilities in direct support to sole federal functions. Operations and maintenance costs for these facilities are funded via cooperative agreements between the federal government and the state military departments. The federal government provides all funding for construction and maintenance of facilities for the USAR.

f. Dual Status Commanders (DSC). A DSC is an ARNG or ANG officer or a specially trained and certified RA or Regular Air Force officer who may, by law, serve in two statuses (Federal and State) simultaneously. In State status, the DSC is a member of the State chain of command, subject to the

orders of the governor and Adjutant General of the DSC's State (exercises command of assigned State NG forces). In Federal status, the DSC is a member of the Federal chain of command, subject to the orders of the President, the Secretary of Defense, and the supported Combatant Commander (Commander, U.S. Northern Command when in the 48 contiguous States, Alaska, D.C., and the territories of Puerto Rico and the U.S.). The President and the Governor of the State must both agree to the establishment of a dual status commander. The designation of a DSC allows establishment of unity of command, typically during CONUS disaster relief / Defense Support to Civil Authorities missions when Title 10 and Title 32 forces are simultaneously employed. 32 USC 325 authorizes a National Guard officer to be placed on active duty without losing their Guard status. 32 USC 315 allows an AC Army or Air Force officer to accept a commission in the NG of a state without losing his/her active status.

## **Section IV Training**

### **6-18. Training Goals**

At current AC force levels, the chances are very high for employment of those land forces in the ARNG and USAR as currently organized, trained, equipped, and prepared. The ability to mobilize quickly and effectively with the proper identification and resourcing of RC capabilities is a key hedge against uncertainty. To have RC formations properly trained, equipped, and prepared for rapid introduction into contingencies or major combat will require higher states of readiness and leader preparation, as well as changes to current mobilization processes.

### **6-19. Training Challenges**

Training is accomplished during four-hour inactive duty training (IDT) periods (during a unit training assembly (UTA) or multiple unit training assembly (MUTA) or during an annual training (AT) period. The same training standards apply to the RC that apply to the AC. One key factor to understanding RC training challenges is comprehending the distinct differences between RC and AC training. Unlike AC units, which have military occupational specialty (MOS)-qualified Soldiers assigned to them by HRC, RC units usually recruit Soldiers from the local area. Whether initial entry or prior service, these Soldiers are assigned to the unit and then must attend MOS qualification training to match the needs of the unit. Qualification training, sustainment training, additional duty training, and professional development education are often conducted in lieu of scheduled UTAs and AT, and in some cases require more than a year to complete. Even though these RC Soldiers are counted against the unit's assigned strength, they are not available to participate in collective training. Another training challenge is that RC Soldiers and units must meet the same standards as AC units in a fraction of the time. Non-directed mission essential task list (DMETL) training, non-core mission essential task list (CMETL) training, and other events, such as Army physical fitness tests (APFT), weapons qualification, mandatory training, inventories, and physicals have a greater impact on the RC because they take the same time as AC units within fewer available days to accomplish them.

### **6-20. Unit Training Assemblies**

ARNG and USAR units, as elements of the Selected Reserve, are normally authorized 48 IDTs and a two-week (e.g., 14-17 days) AT during the training year, which starts on 1 October and terminates on 30 September of the following year. The general trend is to consolidate UTAs during the year so that four UTAs (four each 4-hour IDT blocks, totaling 16 hours) are accomplished during a single weekend. This MUTA-4 configuration provides continuity for individual and crew training, qualification firing, field training, and refresher training.

### **6-21. Collective Tasks**

AT is directed primarily toward collective pre-mobilization tasks. Individual training and weapons qualifications are typically performed during IDT. Soldiers and units train to established pre-mobilization levels of proficiency. Combat maneuver units generally train to individual-, crew-, and platoon-levels of proficiency. CS and/or CSS units are generally required to train to company-level proficiency.

**6-22. State Partnership Program (SPP)**

Army National Guard units conduct military-to-military engagements directly with selected nations in support of defense security goals but also leverage whole-of-society relationships and capabilities to facilitate broader interagency and corollary engagements spanning military, government, economic and social spheres. The SPP has been building relationships for over 20 years and has expanded to 73 unique security partnerships involving 79 nations around the globe. SPP links a unique component of the Department of Defense – a state's National Guard – with the armed forces or equivalent of a partner country in a cooperative, mutually beneficial relationship. The SPP evolved from a 1991 U.S. European Command decision to set up the Joint Contact Team Program in the Baltic Region with Reserve component Soldiers and Airmen. A subsequent National Guard Bureau proposal paired U.S. states with three nations emerging from the former Soviet Bloc and the SPP was born, becoming a key U.S. security cooperation tool, facilitating cooperation across all aspects of international civil-military affairs and encouraging people-to-people ties at the state level. This low-cost program is administered by the National Guard Bureau, guided by State Department foreign policy goals, and executed by the state adjutants general in support of combatant commander and U.S. Chief of Mission security cooperation objectives and Department of Defense policy goals. See figure 6.2.

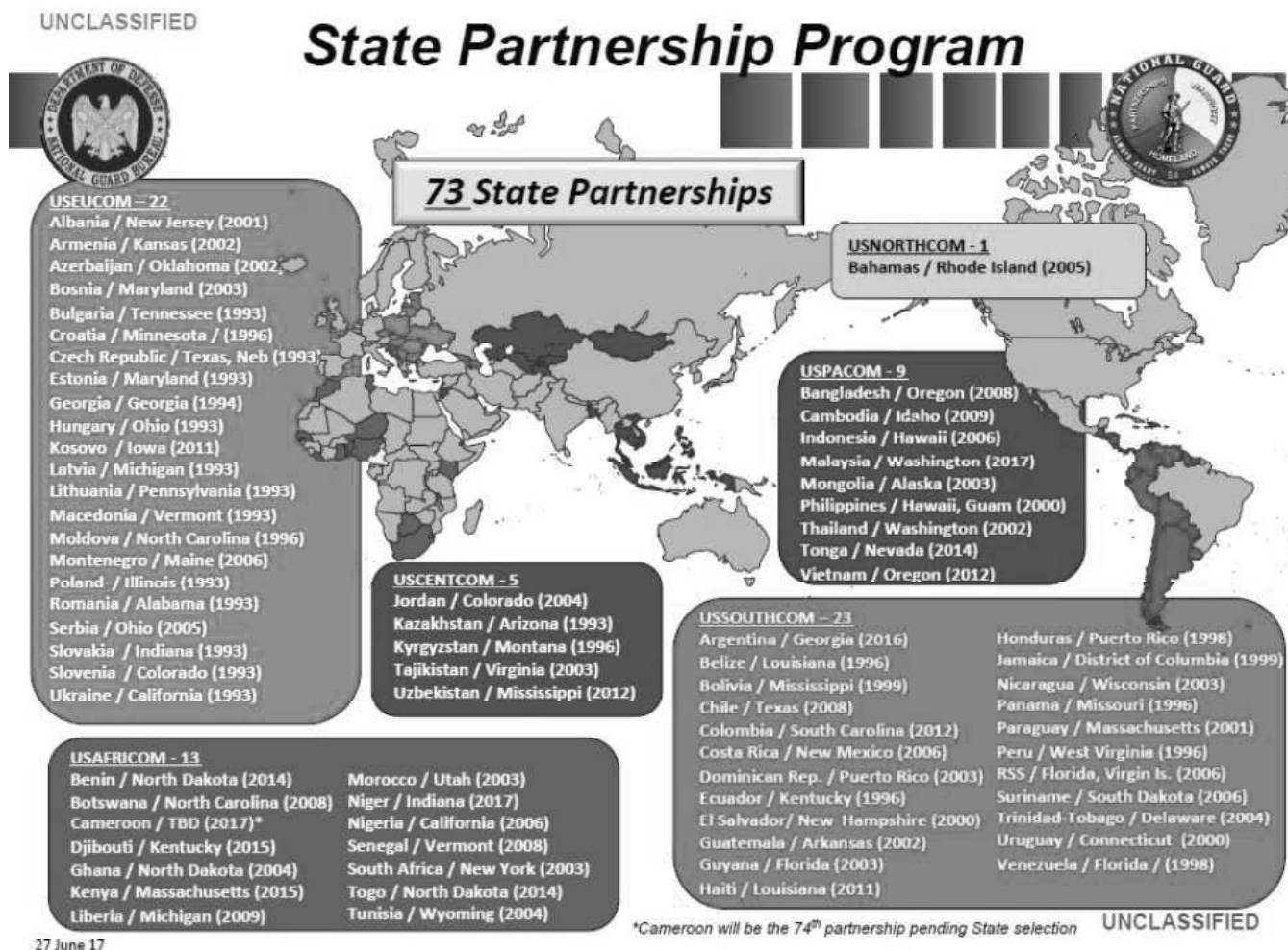

Figure 6-2 State Partnership Program

## Section V Equipment

### 6-23. Equipment Policy

The Army accepted risk during the Cold War by not fully fielding force modernization equipment to authorized levels in the RC. The RC was characterized as a strategic reserve and was not expected to immediately deploy in the event of a crisis. The global strategic environment has changed dramatically over the past two decades and, in order to meet the nation's national security demands today, the RC functions as an operational reserve. In their operational reserve role, the RC' deployment timeline has shortened considerably with the expectation that it will continue to move further away from the Cold War paradigm of mobilize, train, deploy, and closer toward the AC model of train, deploy. As a result, DA policy today distributes equipment to units in first-to-fight and/or first-to-support sequence. Later deploying units are provided the minimum-essential equipment required for training and to achieve acceptable readiness levels. The COMPO to which a unit belongs, with the exception of specified programs (e.g., National Guard and Reserve Equipment Appropriation (NGREA)) is not a factor in equipment distribution. This policy ensures units employed first in time of crisis have the necessary equipment to accomplish the mission. Under this policy, the ARGN and USAR have received substantial amounts of modern equipment in recent years and are programmed to receive more in future years.

### 6-24. National Guard and Reserve Equipment Appropriation (NGREA)

NGREA is a special appropriation designated for the acquisition of equipment for the RC to improve readiness. Congress may further fence these funds for the purchase of specific items of equipment. NGREA funds complement the service appropriations, which primarily fund force modernization, thereby improving training and readiness in the RC. Until the Army is able to support total Army modernization, the continued programming of NGREA funding will allow the ARNG and USAR to procure critical modernization equipment in order to improve survivability and interoperability.

## Section VI Readiness and Mobilization Assistance

### 6-25. Background

In 1973, the Army leadership recognized the potential of many types of RC units for early deployment. Accordingly, the affiliation program was conceived to improve the mobilization and deployment readiness of selected RC units and provide added combat power earlier in the execution of contingency plans. As more structure and missions were added to the RC in the mid-to-late 1970s, the Army instituted several programs to facilitate achievement of higher training readiness levels for the RC. These included the AC/RC partnership program which aligned selected combat and Special Forces RC units with AC units, the counterpart program that aligned ARNG attack helicopter units with AC counterparts, and the corps and division training coordination program (CORTRAIN) that associated AC/RC combat units with a CONUS corps for command post exercises. Together, these programs provided resources and opportunities for RC unit leaders and Soldiers to work closely and share their experiences with their AC counterparts.

### 6-26. Training Support Organizations

The ARNG Combat Readiness Reform Act of 1992 required the Army to assign not less than 5,000 AC personnel to RC units to provide training and readiness advice and support. The Army developed five USAR-flagged training support divisions aligned with First and Fifth Armies composed of AC, ARNG, and USAR personnel to provide collective training support for RC units. Additionally, a portion of the 5,000 personnel were embedded in RC units as full-time support (FTS) personnel. An Army transformation campaign plan realigned the First and Fifth Armies into two different mission areas. Effective July 2006, Fifth Army became Army Forces North (ARNORTH), the Army Service Component Command (ASCC) providing support to United States Northern Command (USNORTHCOM) for DHS and DSCA missions. Effective October 2006, First Army assumed the CONUS mission of mobilizing, training, validating, and deploying RC units. First Army is organized with two divisions (First Army-East and First Army-West) which command training support brigades (TSB), with associated ARNG and USAR elements that provide

exercise support, pre-mobilization training, and post-mobilization validation capability for RC units to ensure Army standards and doctrinal mission capabilities are achieved prior to deployment.

### **6-27. Overseas Deployment Training**

The overseas deployment training (ODT) program provides RC units the opportunity to exercise their skills in a realistic environment with the added benefits of reducing AC operating tempo (OPTEMPO) and providing needed operational support to CCDRs. As part of Army force generation, selected units from may be designated to train in JCS exercises and in non-exercise mission training that enhances their awareness of mobilization and/or deployment processing. The ODT program has provided training opportunities to an increasing number of companies and battalions. ODT reduces mobilization and deployment timelines, enhances readiness, and promotes unit cohesion.

### **6-28. Full Time Support**

a. The FTS program was directed by Congress to increase the readiness of ARNG and USAR units. The majority of FTS personnel work in ARNG and USAR units. The FTS staff performs the day-to-day support functions for the unit to operate including personnel, administration, training, operations, maintenance, and supply which enables Troop Program Unit (TPU) reservists to use their limited training time (e.g., 39 days annually) to concentrate on their wartime tasks instead of sustainment functions.

b. The FTS program consists of AGR Soldiers, military technicians, DA civilians, and AC Soldiers. AGR Soldiers are traditional ARNG and USAR Soldiers who are on active duty. Military technicians and DA civilians are full-time civilian employees. Military technicians have the distinction of also being RC Soldiers who must maintain their reserve status as a condition of employment. The AC assigns Soldiers to support RC units and these Soldiers are considered part of the FTS program. ARNG and USAR technicians provide full-time, day-to-day assistance and support and act as the representative for their commanders during non-UTA periods. Technicians ensure continuity in administration, supply, maintenance, and training and their services are critical to mobilization preparedness. Both ARNG and USAR technicians are federal civil service employees. The USAR technicians are governed by the provisions of the Civil Service System. ARNG technicians are governed by the same provisions except as modified by Public Law 90-486, National Guard Technician Act of 1968, as well as Title 32, USC, 709, and regulations prescribed by the NGB. As a provision of employment in the military technician program, technicians must also be members of the ARNG or USAR. Many technicians are employed in the same unit to which they are assigned. AGR Soldiers serve on active duty in support of the RC. Title 10, USC, AGR personnel are available for worldwide assignment whereas Title 32, USC, AGR personnel receive assignments within their state, territory, or Washington, DC.

### **6-29. The Army School System**

See Chapter 14, Training and Leader Development.

### **6-30. Reserve Component Access**

All of the DOD services access the RC using authorities outlined in Figure 6-3, in conjunction with DOD policies. Access is defined as the requisite authority in concert with the necessary funding. The authority used to mobilize RC Soldiers will significantly impact mission cost and affect service member benefits and entitlements. The RC provides operational capabilities and strategic depth to meet US defense requirements across the full spectrum of conflict. The RC can augment capabilities primarily found in the AC or provide the sole or primary source of a capability not resident in the AC. In their operational roles, elements of the RC participate in a full range of missions according to their services' force generation plans. Units and individuals participate in missions in an established cyclic or periodic manner that provides predictability for the CCMDs, the services, service members, their families, and employers. Preplanned mobilization support, per Title 10, USC, 12304b, gives the MILDEP Secretaries the authority to activate their Selected Reserves up to 365 days to augment the active forces for preplanned missions in support of a CCMD, thus utilizing the RC as an operational reserve with cyclical predictability. In their strategic reserve role, RC units and individuals train or are available for missions in accordance with the national defense strategy. As such, the RC provides strategic depth and is available to transition to operational reserve roles as needed.



### 6-33. Uniform Code of Military Justice

The Uniform Code of Military Justice (UCMJ) was extended to RC members as of 14 Nov 1986, when then President Reagan signed into law the Military Justice Amendment of 1986 as part of the 1987 NDAA. Under these changes, USAR Soldiers are subject to the UCMJ while in an IDT status. The military can now recall a Soldier to active duty for trial for crimes committed while performing ADT or IDT. The decision to activate a Soldier for trial must be approved through the USAR chain of command to the SECARMY if confinement is contemplated. In other cases, the Active Army General Court Martial Convening Authority (GCMCA) is the final decision authority. National Guard personnel are subject to UCMJ authority when in federal service. When in state service, they are subject to their state military code, which is generally patterned after the UCMJ.

## Reserve Component Access

Statute	Utilization Process	Intended Use	Limits
<b>INVOLUNTARY</b>			
<b>10 USC 12301(a) Full Mobilization</b>	Congressional declaration of war or national emergency	Rapid expansion of armed forces to meet an external threat to national security	- No personnel limitation - Duration plus 6 months - Applicable to all reservists (inactive & retired)
<b>10 USC 12301(b) 15-Day Statute</b>	Service Secretary authority to order to active duty without member's consent	Annual training or operational mission	- 15 days active duty once per year - Governor's consent required for National Guard
<b>10 USC 12302 Partial Mobilization</b>	Presidential declaration of national emergency, typically Secretary of Defense-approved force tracking numbers / Department of the Army Execution Order	Manpower required to meet external threat to national emergency or domestic emergency	- Max 1M Ready Reservists on active duty - Not more than 24 consecutive months - Used for Iraq / Afghanistan contingency operations
<b>10 USC 12304</b>	President's signature	Other than during war or national emergency	- 200K Selected Reserve - Max 30K Individual Ready Reserve - 365 days
<b>10 USC 12304 (a/b) Presidential Reserve Call-Up</b> C2: An appointed commissioned officer as a dual-status commander serving on active duty and duty in or with the National Guard of a State	President's authorization required for operational mission; Secretary of Defense can involuntarily mobilize reserve forces for disaster response	12304a Response to major disaster / emergency	- Ready Reserve (no cap) - 120 continuous days
		12304b Preplanned mission in support of Combatant Command	- Ready Reserve - 60K Cap / 365 days - Identified in Defense Budget for FY(s)
<b>VOLUNTARY</b>			
<b>10 USC 12301(d) Active Duty for Operational Support</b>	Service Secretary authority to order to active duty with member's consent	Operational missions (volunteers)	- Applicable to Ready Reserve - Active duty for operational support limits duty to 3 years out of 4 (1095 Rule) - Governor's consent required for National Guard

**Figure 6-3. Reserve Component Access**

## Section VII

### Summary and References

#### 6-34. Summary

Over half of the Army's total deployable forces are in the ARNG and USAR. The management of these forces is of paramount importance. The structure for RC management includes Congress, DOD, HQDA, ACOMs, states, and units. Two key managers at HQDA are the NGB and OCAR. At the ACOM level, USFORSCOM and its subordinate First Army and the USARC have a leading role in preparing RC forces for mobilization and deployment.

#### 6-35. References

- Army Directive 2017-09 Management of the Individual Ready Reserve, 6 Feb 2017.
- Army Regulation (AR) 135-5, Army Reserve Forces Policy Committee, 8 Dec 2014.
- AR 140-1, Army Reserve: Mission, Organization, and Training, 20 Jan 2004.
- AR 140-10, Army Reserve: Assignments, Attachments, Details, and Transfers, 15 Aug 2005.
- AR 140-145, Army Reserve Individual Mobilization Augmentation Program, 21 Mar 2016.
- DOD Directive 1200.17, Managing the Reserve Component as an Operational Force, 29 Oct 2008.
- <http://www.usar.army.mil/Pages/default.aspx>.

## HOW THE ARMY RUNS

- h. <http://www.nationalguard.mil>.
- i. <http://www.usar.army.mil>.
- j. <https://afreserve.com>.
- k. <http://www.public.navy.mil/nrh/Pages/default.aspx>.
- l. <http://www.marforres.marines.mil>.
- m. <http://www.reserve.uscg.mil>.
- n. <http://www.ang.af.mil>.
- o. <http://www.asamra.army.mil>.
- p. Public Law 90-486, The National Guard Technician Act of 1968 (as amended).
- q. Public Law 90-168, The Reserve Forces Bill of Rights and Revitalization Act, 1968.
- r. Title 10, USC.
- s. Title 32, USC.

## Chapter 7

### Force Readiness

#### Section I Introduction

##### 7-1. Chapter Content

a. This chapter describes the updated and emerging changes to readiness and capabilities reporting systems throughout the Department of Defense (DOD). To make the decisions necessary for achieving and maintaining a quality Army with joint and expeditionary capabilities, the DOD, the Joint Chiefs of Staff (JCS), and the Department of the Army (DA) have developed reporting systems to assist the leadership at all levels in managing force readiness.

b. This chapter discusses the methods used for measuring force readiness and the systems and procedures used to respond to force readiness issues. It provides insights regarding the processes qualitatively and quantitatively defining and describing force readiness at the tactical and strategic level. Further, it provides an executive overview of the CRS which establishes a common framework for assessing Unit readiness using force readiness reporting and strategic readiness using the Joint Combat Capability Assessment (JCCA). The JCCA process is used to provide the Chairman of the Joint Chiefs of Staff (CJCS) a strategic readiness assessment of DOD's ability to meet the demands of the National Military Strategy (NMS). Finally, the readiness levels and capability assessments of Army organizations are reported in the DRRS. The Army component of this DOD system is DRRS-Army (DRRS-A).

c. This chapter provides an overview of the ways in which tactical and strategic Army readiness inform Army leaders as well as the Joint Staff (JS) and DOD level readiness reporting requirements and systems.

##### 7-2. Maintaining Readiness

a. Force readiness is an integral function supporting the Army's strategic imperatives to provide modernized and ready, tailored land force capabilities, develop leaders to meet the challenges of the 21st Century, adapt the Army to more effectively provide land power, and enhance the All-Volunteer Army. The Army's readiness reporting process supports requirements established by Congressional National Defense Authorization Act (NDAA), Office of the Secretary of Defense (OSD), Defense Readiness Reporting System (DRRS), Chairman's Readiness System (CRS) and the Army's current force generation process.

b. As the Army continues operating in the 21st century, it confronts the major challenge of maintaining readiness to meet current operational demands in a time of constrained resources. Maintaining readiness requires critical and often difficult decisions by the Army leadership, for they must strive for the proper balance between maintaining current readiness and resourcing future capability requirements.

##### 7-3. Readiness Framework and Reporting

a. *Readiness Framework.* Title 10 and Title 32 United States Code (USC), in conjunction with the annual NDAA, form the statutory requirement for all DOD readiness reporting requirements. The Services and Combatant Commands fulfill these requirements using DRRS to fulfill multiple quarterly and annual readiness assessments to Congress.

b. *Readiness Reporting.* The Army frames readiness reporting through a wide range of diverse inputs into the process (e.g., programs, procedures, doctrine, senior leader guidance, and venues) to address readiness at the unit and Service strategic levels (see Fig 7-1). The venues in which readiness is discussed are—

- (1) Weekly Strategic Readiness Assessment Group (SRAG). An O6 / Action Officer-level venue to discuss and work through various readiness reporting issues.
- (2) Monthly Strategic Readiness Update (SRU). An update to the VCSA with all ACOMs, ASCCs, and ARSTAF in attendance to highlight any issues raised from the SRAG or other topics as directed by the Army Leadership.
- (3) Annual Army Readiness Council of Colonels. A 3-day council held in the Pentagon with representation of all ACOMs, ASCCs, DRUs, and ARSTAF to review and provide recommendations to the Army Senior Leaders on readiness reporting policy or procedure changes.
- (4) Readiness Working Groups. Working groups are established at varying times throughout the year to work readiness reporting specific issues.

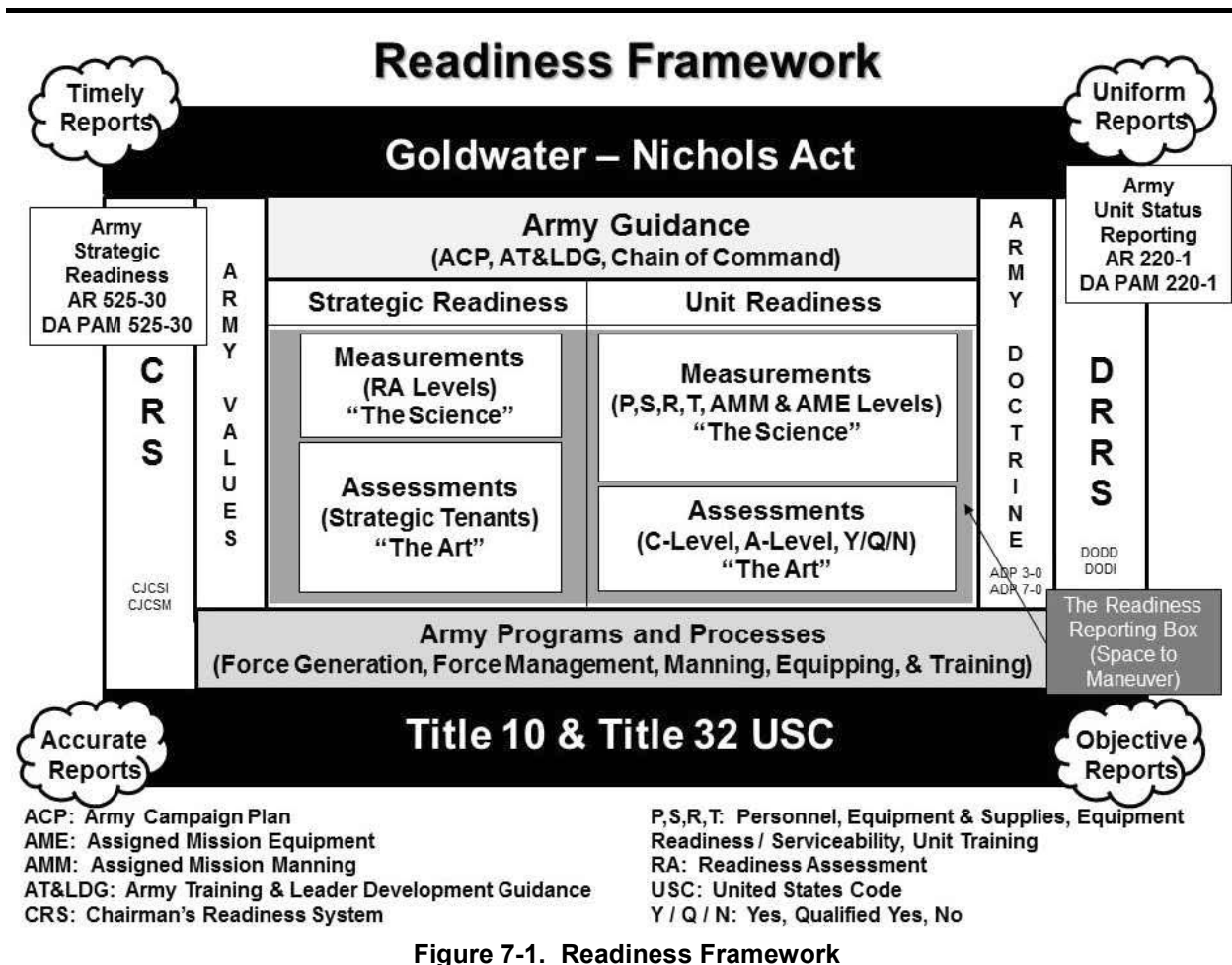

**Section II**  
**Unit Readiness Reporting**

**7-4. Unit Status Reporting Purpose**

Net-Centric Unit Status Report (NetUSR) is the software application used by commanders of Army units to provide readiness input to DRRS-A. The primary purpose of the reports prepared by commanders using NetUSR is to provide the POTUS, SECDEF, JCS, HQDA, and all levels of the Army’s chain of command with the current status of U.S. Army units and necessary information for making operational decisions. The NetUSR application enables commanders to measure and report on the status of resources and the training level in their units at a given point in time. The reports should not be used in isolation to assess overall Army unit readiness or the broader aspects of Army force readiness. The

reports provide a timely single source document for assessing key elements of a unit's status according to the unit commander. It does not provide all the information necessary to manage resources at a strategic level. Army Regulation (AR) 220-1, Army Unit Status Reporting and Force Registration-Consolidated Policies governs the production and submission of unit status reporting.

**7-5. Unit Status Reporting Procedures**

a. Commanders of all reporting units are required to determine and report their assessment of their units' ability to accomplish the core missions for which the units are designed (C-Level), an Assigned Mission Level (A-Level) that reflects their assessments of their units' ability to accomplish their primary directed missions, and also a Chemical-Biological Defense Readiness Training (CBDRT) Level indicating their units' readiness to perform their core mission under chemical or biological conditions. The C-Level, A-Level, and the CBDRT Level are overall levels that are described in Chapter 4 of AR 220-1. There are four measurements (personnel, equipment and supplies on-hand/available, equipment readiness / serviceability, and unit training level proficiency) that support the C-Level determination. Two measurements, Assigned Mission Manning (AMM) and Assigned Mission Equipment (AME), support the A-Level determination. Two measurements (Equipment and supplies and training) support the CBDRT Level determination. These resource and training status measurements are determined using a four tier rating scale. Analysis of these resource and training status measurements provides insight into the measured unit's tactical-level capability (see Fig 7-2).

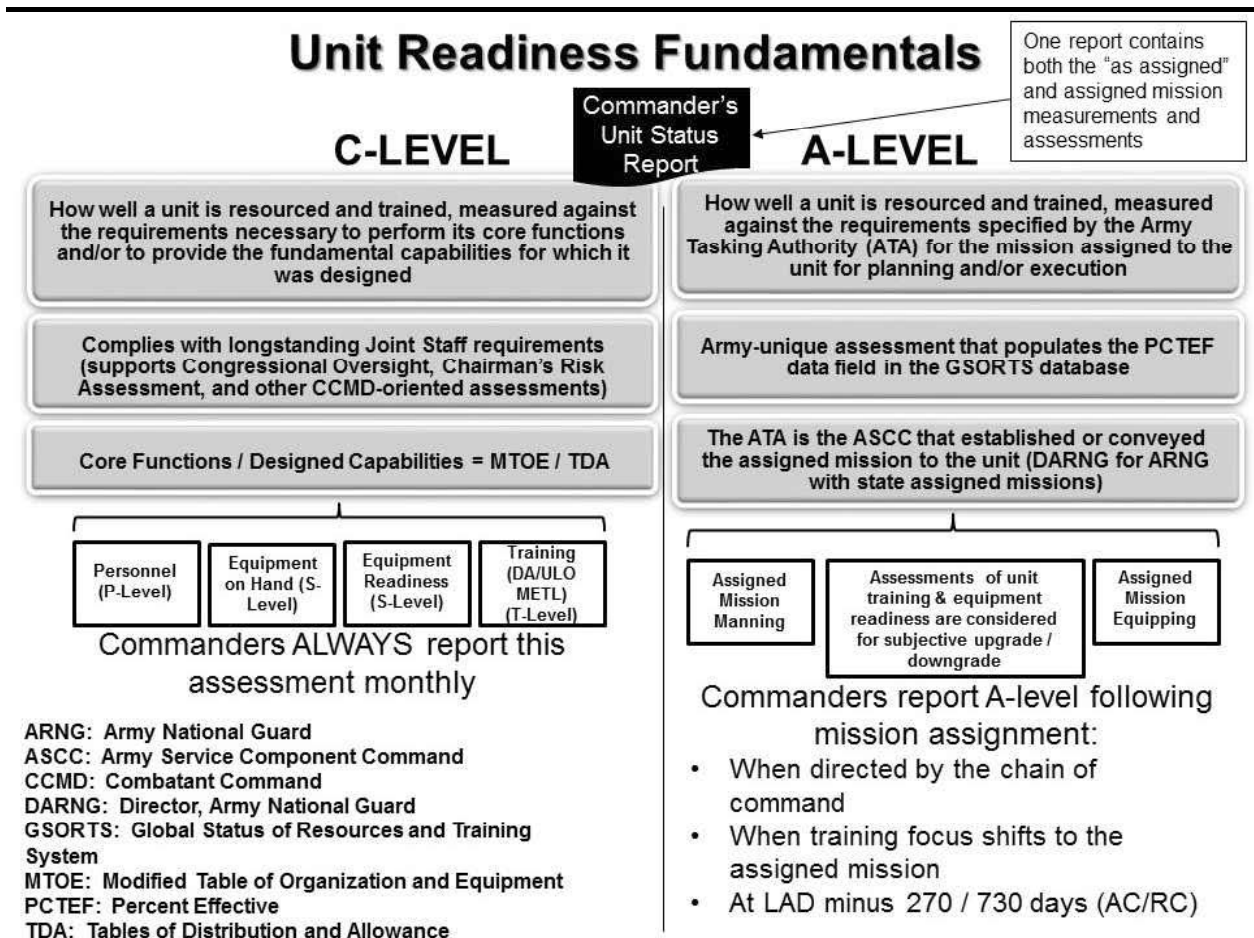

**Figure 7-2. Unit Readiness Fundamentals**

b. Status levels are determined for each of these measured areas to support the overall assessments required. Measured area levels are determined by applying the specific resource or status criteria and metrics. Commanders cannot subjectively upgrade or downgrade the level of a measured area.

c. In general, reporting units will report readiness status against their currently effective Modification of Organization and Equipment (MTOE) / Table of Distribution and Allowances (TDA) document. However, in certain circumstances, units can report early against a future document. AR 220-1, Chapter 7 provides detailed instructions for determining the requirements document.

d. Measured Area Levels.

(1) *Personnel Level (P-Level)*. Army units will measure personnel readiness using three metrics for personnel fill percentages that are based on the unit's strength requirements for its core functions/designed capabilities: 1) total available personnel strength divided by the required strength, 2) available Military Occupational Specialty Qualified (MOSQ) strength by duty position divided by the required strength, and 3) the available senior grade composite level determined by comparing the available and required strength in each of five senior grade categories. The applicable MTOE or TDA that reflects the unit's core functions/designed capabilities is the authoritative source for the unit's required strength. While Army units also are required to determine and report additional personnel data (for example the assigned strength percentage, turnover percentage, and so on), the personnel level is determined solely based on the results of these three P-Level metrics.

(2) *Equipment and Supplies On-Hand (S-Level)*. Army units determine and report an S-Level by determining by Line Item Number (LIN) the on hand/availability status of designated critical equipment items (pacing items) and the on-hand/availability status of the other mission essential equipment items (Equipment Readiness Code (ERC) A) that are listed on the unit's MTOE or TDA. Substitute items prescribed by HQDA via Sustainment Brigade (SB) 700-20 and In Lieu Of (ILO) substitutions directed by HQDA or determined by the commander are applied in accordance with the provisions of paragraph 9-3 of AR 220-1. Note that for this S-Level measurement, the on hand/availability status of equipment items is based solely on those equipment items currently in the unit's possession, under its control or, when applicable, available to it within 72 hours for mission execution. The S-Level measurement is not based solely on property accountability records, and it does not consider the operational readiness/serviceability of the equipment items. A discrete measurement is accomplished at the LIN Level of detail by comparing the equipment items currently in the unit's possession, under its control or available to it within 72 hours, to the equipment items required to accomplish its core functions/designed capabilities, and an S-Level rating is determined for each measurement. The applicable MTOE or TDA that reflects the unit's core functions/designed capabilities is the authoritative source for the unit's equipment requirements. The unit's S-Level rating is determined in accordance with a methodology that considers each of these by LIN S-Level measurements.

(3) *Equipment Readiness / Serviceability (R-Level)*. Army measured units will measure the operational readiness or serviceability of the critical equipment items that are in their possession, under their control or available to them within 72 hours, and that are designated by HQDA via the Maintenance Master Data File (MMDF) as reportable for maintenance. Separate measurements will be accomplished for each maintenance reportable pacing item and for all maintenance reportable equipment currently in the unit's possession (aggregate). An R-Level rating is determined for each measurement, and, subsequently, the unit's R-Level rating is determined in accordance with a methodology that considers each of these R-Level measurements.

(4) *Unit Training Level Proficiency (T-Level)*. T-Level is an assessment of the unit's training proficiency to accomplish its designed capabilities based upon a composite assessment of four foundational components of training; 1. Individual / Crew / Platform Qualification conducted IAW appropriate doctrinal reference; 2. Mission Essential Task (MET) Proficiency demonstrated through evaluation of collective task proficiency during training events IAW MET Training and Evaluation Outlines (T&EO); 3. Collective Live Fire Proficiency demonstrated through evaluation of collective task proficiency under live fire conditions IAW T&EO; 4. Minimum number of continuous training days (T-Days), unconstrained by resources, required to achieve T1. T-days is derived from a unit's approved training plan and further refined thru Commander-to-Commander dialogue to account for likely contingency deployment requirements. Often, training readiness is a somewhat subjective assessment of a unit's ability to accomplish its assigned mission. The Army is in the process of implementing a more objective evaluation system for Training Readiness called OBJECTIVE-T. This system will provide detailed metrics that will assist the commander in making a training assessment and will provide a common standard for training assessments.

e. *Determining the Unit's C-Level*. To determine the overall C-Level, the commander reviews the status levels attained in the four measured resource areas. The overall unit C-Level will normally be the lowest

level recorded in any of the unit's individually measured resource areas of personnel, equipment and supplies on-hand, equipment readiness/serviceability, and unit training level proficiency. There may be circumstances in which commanders may subjectively upgrade or downgrade a unit's C-Level based on mission evaluation, but the status level computed for each individually measured area must be reported without adjustment.

(1) Overall Levels. The overall category level (C-1, C-2, C-3, C-4, C-5) indicates the degree to which a unit has achieved prescribed levels of fill for personnel and equipment, the training status of those personnel, and the maintenance status of the equipment. When assigned a current operational requirement, units also report an A-Level to indicate their readiness level for the current assigned mission. The four areas for which specific levels are calculated to support the C-Level determination are described in paragraph d. above. These measured area levels reflect the status of the unit's resources and training measured against the resources and training required to undertake the wartime mission for which the unit is organized or designed. Category levels do not project a unit's combat ability once committed to action. The overall unit category level will be based only upon organic resources and training under the actual control of the reporting unit or its parent unit. The C-Level categories follow.

(a) C-1. The unit possesses the required resources and is trained to accomplish or provide the core functions and fundamental capabilities for which it was designed or to undertake the mission it is currently assigned. The status of resources and training in the unit does not limit flexibility in methods to accomplish core functions or assigned missions nor increase vulnerability of unit personnel and equipment. The unit does not require any compensation for deficiencies.

(b) C-2. The unit possesses the required resources and is trained to accomplish or provide most of the core functions and fundamental capabilities for which it was designed or to undertake most of the mission it is currently assigned. The status of resources and training in the unit may cause isolated decreases in the flexibility of choices to accomplish core functions or currently assigned missions. However, this status will not increase the vulnerability of the unit under most envisioned operational scenarios. The unit will require little, if any, compensation for deficiencies.

(c) C-3. The unit possesses the required resources and is trained to accomplish or provide many, but not all, of the core functions and fundamental capabilities for which it was designed or to undertake many, but not all, portions of the mission it is currently assigned. The status of resource and training in the unit will result in significant decreases in flexibility to accomplish the core functions or the assigned missions and will increase vulnerability of the unit under many, but not all, envisioned operational scenarios. The unit will require significant compensation for deficiencies.

(d) C-4. The unit requires additional resources or training to accomplish or provide the core functions and fundamental capabilities for which it was designed or to undertake the mission currently assigned; however, the unit may be directed to undertake portions of the assigned mission with resources on hand (available).

(e) C-5. The unit is undergoing a HQDA-directed resource action and/or is part of a HQDA-directed program and is not prepared to accomplish or provide the core functions or fundamental capabilities for which it was designed. Units report C-5 in accordance with the policy and procedures established in paragraph 4–8 of AR 220-1. Level 5 is not applicable to A-Level reporting. C-5 units are restricted to the following.

(1) Units undergoing activation, inactivation, conversion, or other HQDA directed resource action.

(2) Units that have their levels for authorized personnel and/or equipment established so that, even when filled to the authorized level, the established level does not allow the unit to achieve level 3 or higher.

(3) Units that are not manned or equipped but are required in the wartime structure.

f. Determining the Unit's A-Level. The A-Level is an overall readiness assessment that reflects the unit's ability to accomplish the assigned mission that it is preparing for, has been ordered to execute and / or is executing. Similar to the C-Level, the A-Level contains measured resource areas that indicate the availability status of resources (personnel and equipment) measured against the assigned mission requirements that have been established or conveyed by the Army Tasking Authority. If the core mission is directed for execution, then the A-Level and C-Level will coincide.

g. NetUSR data is transmitted through Administrative Control (ADCON) channels. Reporting units are required to submit a unit status report covering their specific resource and training status levels, their overall C-Levels, and their individual and overall MET assessments.

Section III  
Strategic Readiness

7-6. Strategic Readiness Reporting Purpose

a. Strategic Readiness is the assessment of the Army and its Army Commands (ACOM), Army Service Component Commands (ASCC) and Direct Reporting Units' (DRU) ability to meet its current and future Title 10 responsibilities in support of the NMS. The Army Strategic Readiness Assessment (ASRA) is a quarterly comprehensive analysis of the Army's strategic readiness levels across the total force necessary to inform the Army's senior leaders, the Joint Staff, OSD, and Congress on the status of the Service to meet the demands of the NMS. This assessment combines objective, quantitative, empirical, qualitative, and subjective strategic measures and indicator assessments to portray a holistic view of current and projected strategic readiness. The ASRA is the Army's source document to meet readiness reporting requirements of the JFRR and the QRRC. It also assists senior leaders in congressional hearing preparation, questions for the record (QFR) responses, the comprehensive Joint assessment (CJA), chairman's risk assessment (CRA), and the Secretary of Defense Risk Mitigation Plan. Figure 7-3 visually depicts the relationship of unit reports, the Army's strategic readiness tenets (SRT), and Joint Staff criteria used to develop the ASRA.

Army Strategic Readiness Process

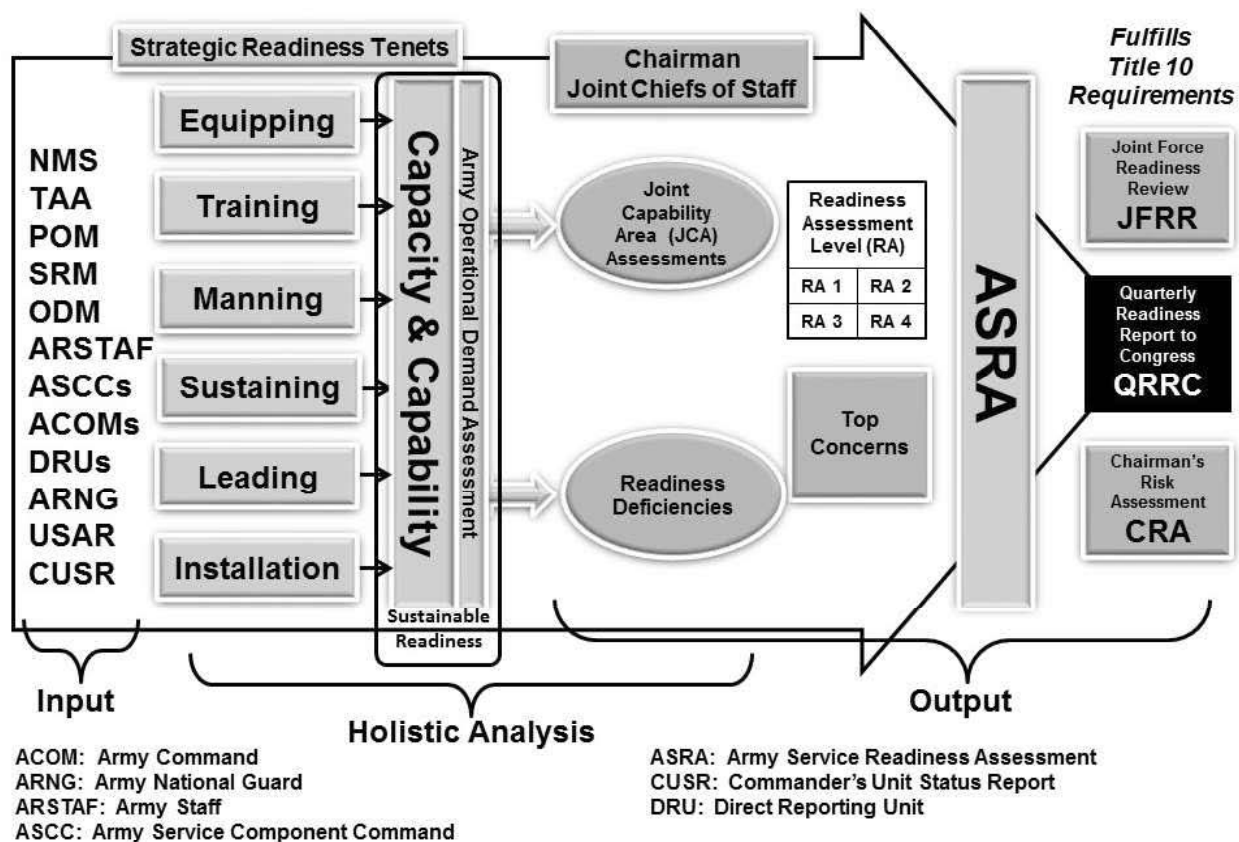

Figure 7-3. Army Strategic Readiness Process

b. The ASRA process includes determining, analyzing, assessing, and reporting Army strategic readiness in accordance with the three Joint Staff criteria (JCAs, Army plan assessment, and readiness deficiencies) and six Army strategic readiness tenets (manning, equipping, sustaining, training, installations, and capacity and capability). The ASRA prepares the analysis by criteria, key indicators, and measures and develops the assessment through the Strategic Readiness Assessment Group



(SRAG). The ASRA is then delivered quarterly to the Army's senior leaders and the information within is used for the computation of the JFRR, QRC, and CRA.

### 7-7. Joint Staff Criteria

The Army uses four strategic readiness criteria to determine the ASRA. In accordance with CJCSI 3401.01E, three criteria are mandated by the Joint Staff. They are JCA assessments, Army plan assessments, and overall readiness deficiencies. These three joint staff criteria incorporate the Army's Title 10 USC "man, train, equip" responsibilities and demonstrate how they directly affect joint operations in support of the NMS.

a. Joint Capability Areas (JCA). The nine JCA assessments are the first of the three mandatory Joint Staff criteria that inform the ASRA. JCAs are collections of like DOD capabilities functionally grouped to support capability analysis, strategy development, investment decision making, capability portfolio management, and capabilities-based force development and operational planning. JCA assessments are given a score based on the Joint Staff readiness metric, as follows:

- (1) *Yes (Y)*. The organization can accomplish the task to established standards and conditions.
- (2) *Qualified Yes (Q)*. The organization can accomplish all or most of the task to standard under most conditions. The specific standards and conditions, as well as the shortfalls or issues impacting the unit's task, must be clearly detailed in the Mission Essential Task (MET) assessment.
- (3) *No (N)*. The organization is unable to accomplish the task to prescribed standard and conditions at this time.

b. Army Plans Assessment. The Army plans assessments are a reflection of the Army's ability to source combatant command (CCMD) operational plans (OPLANs) and assessments of the Army's METs and are composed of Joint combat capability assessment-plan assessments (JCCA-PA), time phased deployment data (TPFDD) readiness analysis, apportionment table readiness analysis, and the ASCC's MET analysis.

c. Army Readiness Deficiencies. Readiness deficiencies are submitted by ACOMs ASCCs, DRUs, ARNG, and USAR. Readiness deficiencies are defined in CJCSI 3401.01E as a shortfall of resources to meet the requirements of a reporting organization's assigned mission, plan, or other documented responsibility. They provide the commanders of the various stakeholders with an opportunity to highlight the specific issues that most affect their units.

### 7-8. Army Criteria

The Army criteria are composed of six Strategic Readiness Tenets (SRT), including manning, equipping, sustaining, training, installation, and capacity and capability. SRTs are quantitative and qualitative measures that provide leading indicators of future Army readiness.

a. Manning. The manning tenet assesses the Army's ability to provide qualified personnel on time to meet the needs of the Army and the CCDRs in support of the NMS. The manning tenet covers human resource functions from the tactical to the strategic level.

b. Equipping. The equipping tenet of readiness assesses the Army's ability to properly equip and modernize forces to meet the needs of the Army and the CCDRs in support of the NMS. Any trend or issue that affects the ability of the Army to equip the force is relevant to this analysis.

c. Sustaining. The sustaining tenet of readiness assesses the Army's ability to project and sustain forces to meet the needs of the Army and the CCDRs in support of the NMS. The sustainment tenet covers logistics functions from the tactical to strategic level.

d. Training. The training tenet of readiness assesses the Army's ability to properly develop leaders, train individuals, and train units to meet the needs of the Army and the CCDRs in support of the Army training strategy, Army leader development strategy, and the NMS.

e. Installation. The installation tenet of readiness assesses the Army's ability to achieve mission excellence through streamlined processes, strategic partnerships, and good stewardship of resources that address Army priorities and meet the mission requirements of senior commanders. This translates into the ability to provide a growing and transforming Army with the infrastructure and support services it needs to remain a highly effective, expeditionary and campaign-quality force, today, and in the future.

f. Capacity and Capability. The capacity and capability tenet assesses the ability of the total force to provide Army forces with sufficient capacity and the capability (readiness) to execute current operations, projected operational demand, and surge requirements established in strategic documents including the

Defense Strategic Guidance (DSG), Global Employment of the Force (GEF), and the Global Force Management Allocation Plan (GFMAP).

### 7-9. Readiness Assessment

a. In order to develop an overall assessment and to ensure common language when assessing the cumulative effects of readiness assessments across all readiness tenets and criteria, it is essential that assessments are conducted within a common framework. The Army's overall strategic assessment will follow the existing CRS, as outlined in CJCSI 3401D. This will allow a seamless transition of the Army assessment to the CRS. The Army will use the readiness assessments (RA) outlined in CJCSI 3401.01E in the overall assessment of each strategic readiness tenet, as follows—

(1) RA-1. Issues and/or shortfalls have negligible impact on readiness and ability to accomplish assigned mission(s) in support of the NMS as directed in the Global Employment of the Force (GEF) and Joint Strategic Capabilities Plan (JSCP).

(2) RA-2. Issues and/or shortfalls have limited impact on readiness and ability to accomplish assigned mission(s) in support of the NMS as directed in the GEF and JSCP.

(3) RA-3. Issues and/or shortfalls have significant impact on readiness and ability to accomplish mission(s) in support of the NMS as directed in the GEF and JSCP.

(4) RA-4. Issues and/or shortfalls preclude accomplishment of assigned mission(s) in support of the NMS as directed in the GEF and JSCP.

### 7-10. Chairman's Readiness System

a. The CRS was implemented in 1994. While it has been incrementally modified since then, it was significantly revised in 2002, 2004, 2007, and then most recently in November of 2010. The CRS provides a common framework for conducting commanders' readiness assessments, blending unit-level readiness indicators with Combatant Command (CCMD), Service, and Combat Support Agency (CSA) (collectively known as C/S/A) subjective assessments of their ability to execute the NMS. Title 10 United States Code (USC) section 117d, requires the CJCS to conduct, on a quarterly basis, a joint review to measure the level of current military readiness based upon the reporting of the capability of the armed forces to carry out their wartime missions. The quarterly JCCA does this through the Joint Force Readiness Review (JFRR) which compiles the Services', CCMDs', and CSA's readiness assessments. Additionally, plans assessments, a readiness deficiency assessment and a quarterly readiness report to Congress are performed. The CRS, through JCCA, provides the means to meet the CJCS's statutory requirements while supporting a process that provides timely and accurate reporting to the DOD leadership.

b. The CJCS is responsible for assessing the strategic level of readiness of the Armed Forces to fight and meet the demands of the full range of operations required by the military strategy. Readiness at this level is defined as the synthesis of readiness at the joint and unit levels. It also focuses on broad functional areas, such as intelligence and mobility, to meet worldwide demands. Joint readiness is the responsibility of the CCDRs. It is defined as the commander's ability to integrate and synchronize combat and support forces to execute assigned missions. Unit readiness is the primary responsibility of the Services and the United States Special Operations Command (USSOCOM). Unit readiness is defined as the ability to provide the capabilities required by CCDRs to execute their assigned missions. The CSAs are responsible for providing responsive support to the operating forces in the event of war or threat to national security. These definitions are considered key because they delineate the responsibilities of the CJCS, Service Chiefs, CCDRs, and CSA directors in maintaining and assessing readiness (see Fig 7-4). The forum within the CRS for the assessment of joint, unit, and CSA readiness is the JFRR.

## Chairman's Readiness System

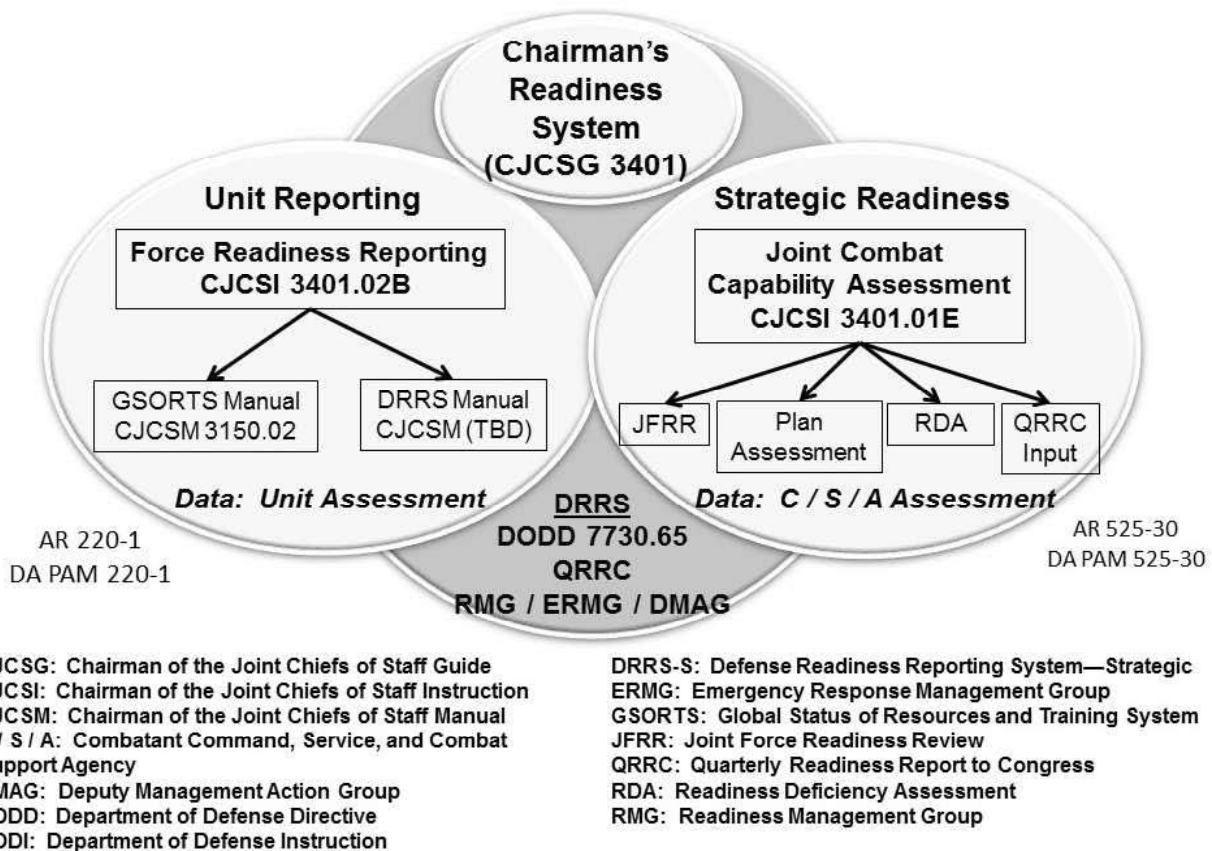

**Figure 7-4. Chairman's Readiness System**

### 7-11. Chairman's Readiness System Outputs

a. The outputs of the CRS are synchronized to inform, through the Comprehensive Joint Assessment (CJA), other Joint Staff and OSD processes to include: J-5's CJCS's Risk Assessment (CRA); J-8's Annual Report on CCDR Requirements and OSD's Quarterly Readiness Report to Congress. Through these informative relationships, the CRS does the following.

- (1) Ensures senior leaders and staffs are operating off a common readiness picture.
- (2) Supports the development of coordinated strategic documents.
- (3) Is synchronized to facilitate timely senior leader decision making.
- (4) Helps the Secretary of Defense (SECDEF) and CJCS fulfill their statutory requirements under Title 10 USC.

b. The strategic documents mentioned above and discussed in greater detail below help align ends, ways, means, and risks to accomplishing the NMS and enable the CJCS to provide the best military advice to the President of the United States (POTUS) and the SECDEF.

(1) *CRA*. In accordance with Title 10 USC Section 153 (b)(1), "the CJCS shall submit to the SECDEF a report providing the CJCS's assessment of the nature and magnitude of the strategic and military risks associated with executing the missions called for in the NMS." To help fulfill this statutory requirement, the JCCAG will forward to the J-5, annually, the Joint Combat Capability Assessment and the results of Plans Assessments to inform the CRA.

(2) *Annual Report on CCDR Requirements*. In accordance with Title 10 USC Section 153 (c)(1), "the CJCS shall submit to the congressional defense committees a report on the requirements of the CCMDs." In addition to consolidating the combatant command integrated priority lists, the report will "address each deficiency in readiness identified during the joint readiness review" (Title 10 USC Section 117 (d)(1)(a)).

To help fulfill this statutory requirement, the JCCAG will forward to the J-8, annually, the Readiness Deficiency Assessment identifying the following.

- (a) CCMD readiness deficiencies reported over the fiscal year.
- (b) CCMD readiness deficiencies closed over the fiscal year.
- (c) The status of CCMD readiness deficiencies not yet closed.

(3) *Quarterly Readiness Report to Congress*. Section 482 of Title 10 USC requires that within 45 days following the end of each calendar quarter a report be sent to Congress based on military readiness. The QRRC is reviewed and approved by the SECDEF and forwarded to Congress and fulfills this requirement.

## Section IV Department of Defense Readiness Reporting System

### 7-12. Department of Defense Readiness Reporting System Overview

DRRS establishes a mission-focused, capabilities-based application that provides DOD users a collaborative environment to facilitate operational decision-making via readiness evaluation of U.S. Armed Forces in support of assigned missions. DRRS is a unique network of applications identifying the capabilities of military forces. The information in DRRS goes well beyond the standard resource accounting approach of traditional readiness reporting by providing assessments of each organization's ability to conduct assigned tasks either in the context of their core mission or other assigned operations. In addition, DRRS improves the efficiency of readiness reporting by merging previously unrelated stovepipe data into a single integrated, authoritative source. DRRS establishes a common language of tasks, conditions, and standards to describe capabilities essential to the completion of assigned missions. The valuable data within DRRS is used to provide timely, accurate readiness information including overall mission readiness and individual task readiness.

### 7-13. Department of Defense Readiness Reporting System Army Overview

DRRS-A is the Army-Specific Implementation of the DOD DRRS.

a. DRRS-A was developed by HQDA G-3/5/7 to accommodate the ongoing development and implementation of additional and/or revised readiness status reporting and force registration requirements by the SECDEF, the CJCS, and the Secretary of the Army (SECARMY)/Chief of Staff, U.S. Army (CSA) to meet their responsibilities under Title 10 USC. It is a family of related and supporting systems that includes: the DRRS-A database; the Net-Centric Unit Status Report (NetUSR) application; the Force Registration application; the Force Projection application; and the Army Readiness Management System (ARMS). DRRS-A also supports the evolution of Army force generation concepts and processes for manning, equipping, and training and the reporting of the progressive readiness of Army forces for unified land operations. The DRRS-A database is the Army's official readiness reporting database and the authoritative database of record and central registry for all currently existing and approved Army units, organizations, and installations. The DRRS-A database replaced the Army Status of Resources and Training System (ASORTS) database during FY 2008.

b. DRRS-A Key Applications.

(1) *The NetUSR Application*. A web-based readiness status data input tool that imports data from designated authoritative sources for reference to support required commander readiness status assessments. The NetUSR replaced the Personal Computer-Army Status of Resources and Training System (PC-ASORTS) application as the Army's official readiness status data input tool in October 2006.

(2) *The Force Registration Application*. A web-based force management data input tool used by Army force registration officials and Unit Identification Code Information Officers (UICIO) to formally register currently existing and approved Army organizations and to update Basic Identity Data Elements (BIDE) in the DRRS-A database.

(3) *The Army Readiness Management System (ARMS) Application*. The official DRRS-A business intelligence and output tool that provides visibility to selected Army readiness status and force registration data and information contained in the DRRS-A database and facilitates the detailed analysis of readiness status trends and force registration issues.

(4) *The Force Projection Application*. This application provides execution information for the mobilization of Reserve Component forces in support of ongoing operations. Additionally, Force Projection provides mobilization and execution data to the Joint Operations Planning and Execution

System (JOPES) in support of deployment operations to include validation requirements, strategic airlift schedules, and status of the deployment flow in conjunction with the Computerized Movement Planning and Status System (COMPASS).

c. The Army developed the DRRS-A to accommodate the evolution of DRRS and to provide the readiness reporting flexibility necessary to support the current Army force generation process for manning, equipping, training, and readiness. The DRRS-A is a capabilities-based, adaptive, near-real-time readiness reporting system that ensures seamless coordination between the Army, OSD, and the CCDRs. It is linkage to the Army authoritative databases for personnel, medical, logistics, installations, training, and force management.

#### **7-14. Use of Defense Readiness Reporting System Army Data at Headquarters, Department of the Army**

a. At HQDA, DRRS-A data is part of a larger readiness picture compiled from many functional reports and sources. It alerts senior leaders to unit readiness issues, helps identify potential strategic readiness trends, and assist in determining if leader decisions are having the desired effect across the Army. The appropriate management actions or the required assistance can be exercised. DA uses DRRS-A data in conjunction with other personnel and logistics reports to improve resource management of people, equipment, and the programming of facilities and training areas to increase the combat effectiveness of subordinate elements.

b. Unit commanders prepare their status reports using the NetUSR application and submit them through their major commands into the DRRS-A database. Subsequently, the Office of the Deputy Chief of Staff (ODCS), G-3/5/7 compiles the reports and provides them to Global Status of Resources and Training Systems (GSORTS) and the DOD DRRS. ODCS, G-3/5/7's ARMS allows all DA Staff elements and other ARMS users to access for analysis via Secure Internet Protocol Router Network (SIPRNet) all unit reports in the DRRS-A database.

c. The Vice Chief of Staff, U.S. Army (VCSA) receives a monthly Strategic Readiness Update (SRU) from the ODCS G3/5/7, with significant input and analysis from the ODCS G-1, ODCS G-4, ODCS G-8, and other Army Staff (ARSTAF) elements. The current readiness status and trend analysis of major units is provided as well as the Army's continual strategic readiness posture.

d. Each principal DA Staff element uses the information provided by the ODCS, G-3/5/7 to influence resource allocation. Aggregate data in DRRS-A also serves as a yardstick to measure how well the functional management system for personnel, logistics, and training are performing.

### **Section V**

#### **Summary, Key Terms, and References**

#### **7-15. Summary**

Readiness is a primary mission of military forces. Recognizing that readiness is highly situational and subjective, it is, nevertheless, a yardstick for programming and budgeting. The Army's readiness strategy entails maximizing readiness within available resources to meet the operational demands resulting from expeditionary requirements and contingency force requirements. The more accurately the Army captures and quantifies readiness, the better the Army can articulate resource needs to the DOD and the Congress.

#### **7-16. Key Terms**

a. *Overall Category Level 1 (C-1)*. The unit possesses the required resources and is trained to accomplish or provide the core functions and fundamental capabilities for which it was designed or to undertake the mission it is currently assigned. The status of resources and training in the unit does not limit flexibility in methods to accomplish core functions or assigned missions nor increase vulnerability of unit personnel and equipment. The unit does not require any compensation for deficiencies.

b. *Overall Category Level 2 (C-2)*. The unit possesses the required resources and is trained to accomplish or provide most of the core functions and fundamental capabilities for which it was designed or to undertake most of the mission it is currently assigned. The status of resources and training in the unit may cause isolated decreases in the flexibility of choices to accomplish core functions or currently

assigned missions. However, this status will not increase the vulnerability of the unit under most envisioned operational scenarios. The unit will require little, if any, compensation for deficiencies.

c. *Overall Category Level 3 (C-3)*. The unit possesses the required resources and is trained to accomplish or provide many, but not all, of the core functions and fundamental capabilities for which it was designed or to undertake many, but not all, portions of the mission it is currently assigned. The status of resource and training in the unit will result in significant decreases in flexibility to accomplish the core functions or the assigned missions and will increase vulnerability of the unit under many, but not all, envisioned operational scenarios. The unit will require significant compensation for deficiencies.

d. *Overall Category Level 4 (C-4)*. The unit requires additional resources or training to accomplish or provide the core functions and fundamental capabilities for which it was designed or to undertake the mission currently assigned; however, the unit may be directed to undertake portions of the assigned mission with resources on hand (available).

e. *Overall Category Level 5 (C-5)*. The unit is undergoing a HQDA-directed resource action and/or is part of a HQDA-directed program and is not prepared to accomplish or provide the core functions or fundamental capabilities for which it was designed. Units report C-5 in accordance with the policy and procedures established in paragraph 4–8 of AR 220-1. Level 5 is not applicable to A-Level reporting. C-5 units are restricted to the following: units undergoing activation, inactivation, conversion, or other HQDA directed resource action; units that have their levels for authorized personnel and/or equipment established so that, even when filled to the authorized level, the established level does not allow the unit to achieve level 3 or higher; and units that are not manned or equipped but are required in the wartime structure.

f. *Readiness Assessment Level 1 (RA-1)*. Issues and/or shortfalls have negligible impact on readiness and ability to accomplish assigned mission(s) in support of the NMS as directed in the Global Employment of the Force (GEF) and Joint Strategic Capabilities Plan (JSCP).

g. *Readiness Assessment Level 2 (RA-2)*. Issues and/or shortfalls have limited impact on readiness and ability to accomplish assigned mission(s) in support of the NMS as directed in the GEF and JSCP.

h. *Readiness Assessment Level 3 (RA-3)*. Issues and/or shortfalls have significant impact on readiness and ability to accomplish mission(s) in support of the NMS as directed in the GEF and JSCP.

i. *Readiness Assessment Level 4 (RA-4)*. Issues and/or shortfalls preclude accomplishment of assigned mission(s) in support of the NMS as directed in the GEF and JSCP.

### 7-17. References

- a. Army Regulation (AR) 220-1, USR and Force Registration - Consolidated Policies.
- b. AR 525-30, Army Strategic Readiness.
- c. AR 700-138, Army Logistics Readiness and Sustainability.
- d. Chairman of the Joint Chiefs of Staff (CJCS) Guide 3401D, CJCS Guide to the CRS.
- e. CJCS Instruction (CJCSI) 3401.01E, CRS.
- f. CJCSI 3401.02B, Force Readiness Reporting.
- g. CJCS Manual 3150.02, Global Status of Resources and Training System.
- h. Department of Defense Directive (DODD) 5149.2, Senior Readiness Oversight Council (SROC).
- i. DODD 7730.65, DRRS.
- j. "Initial Message to the Army," General Mark A. Milley, 26 Aug 15.
- k. OSD Personnel and Readiness (P&R), DRRS Primer for Senior Leaders.

## Chapter 8

### Army Planning, Programming, Budgeting, and Execution Process

#### Section I Introduction

##### 8-1. Chapter Content

- a. This chapter describes how, beginning in CY 2018, DOD and Army Planning, Programming, Budgeting, and Execution (PPBE) processes acquire, allocate, and manage resources for military functions. Prescribed by Army Regulation (AR) 1-1, the Army PPBE process is a component of the DOD PPBE process governed by DOD Directive (DODD) 7045.14.
- b. This chapter details the responsibilities of Army officials for overseeing Army PPBE, managing the several phases of the Army PPBE process, and performing PPBE-related operational tasks.
- c. Finally, this chapter highlights principal forums and other key characteristics of the DOD and Army PPBE processes, provides a graphic representation of the processes' recurring events and organizational structure, and concludes with a phase-by-phase discussion of the annual PPBE process.

#### Section II Department of Defense Planning, Programming, Budgeting, and Execution Process

##### 8-2. Purpose

- a. The DOD PPBE process serves as the primary resource management system for the department's military functions. Its purpose is to produce a plan, program, and defense budget in support of combatant commanders (CCDR). The system documents the program and budget in the Future Years Defense Program (FYDP) data base.
- b. Process and Structure. See Figure 8-1 and 8-2 for PPBE phase summaries.

##### 8-3. National Security Council Guidance

The National Security Council (NSC) writes the National Security Strategy (NSS), which bears significantly on the PPBE process. The NSS outlines the major objectives for the nation, addresses how the U.S. plans to deal with other nations, and provides DOD guidance related to the capabilities required to implement the NSS. See Chapter 2, Strategy, for more detail on the NSS.

##### 8-4. Office of the Secretary of Defense Guidance

Office of the Secretary of Defense (OSD) planning also drives the PPBE process. PPBE planning examines the military posture of the U.S. in comparison to national security objectives and resource limitations. In addition, PPBE planning provides a framework of requirements, priorities, and risk. OSD uses the framework to give each CCDR the best mix of forces, equipment, and manpower attainable within defined fiscal constraints. See Chapter 2, Strategy, for more detail on defense-level strategy, to include the Defense Planning Guidance (DPG) and Guidance for Employment of the Force (GEF).

##### 8-5. Joint Strategic Planning System Guidance

The Joint Strategic Planning System (JSPS) is used by the Chairman of the Joint Chiefs of Staff (CJCS) to provide advice to the NSC concerning the strategic direction of the armed forces and defense policy, programs, and budgets. The system is described in detail in Chapter 2, Strategy. The two key documents produced by the system to inform the PPBE process are:

- a. *Chairman's Program Recommendation (CPR)*. The classified CPR compares planning guidance and objectives with current and projected resource profiles from the most recent President's Budget (PB) and

related FYDP. The CPR focuses on recommendations that will enhance joint readiness, promote joint doctrine and training, and better satisfy joint warfighting requirements. The CJCS solicits ideas from the CCDRs and the services in the preparation of the CPR.

b. *Chairman's Program Assessment (CPA)*. The classified CPA checks the balance and capabilities of composite force and support levels recommended by service Program Objective Memorandums (POM). The CPA compares recommended capabilities and levels with priorities established by the Secretary of Defense (SECDEF). The document helps the SECDEF make decisions during OSD program and budget review reflected in Resource Management Decisions (RMD). Both the CPA and CPR are considered personal CJCS recommendations to the SECDEF and are not widely distributed in their final forum.

## DOD PPBE Phases

<b>Planning</b>	<p>National Security Strategy (NSS)—Annually with President's Budget (PB)—White House                      National Military Strategy (NMS)—Biennially—Chairman, Joint Chiefs of Staff (CJCS)                      Defense Strategy Review (JSR) [previously QDR]—Quadrennial with PB—Office of the SECDEF (OSD)                      Defense Planning Guidance (DPG)—Annually—OSD                      The Army Plan (TAP)—Annually—Headquarters, Department of the Army (HQDA)—Consists of:                      • Army Vision (AV)—Quadrennial with JSR—Secretary of the Army / Chief of Staff of the Army                      • Army Strategic Plan (ASP)—Quadrennial, 120 days after AV—HQDA, G-3/5/7 DAMO-SSP                      • Army Planning Guidance (APG)—Annually 4 July—HQDA, G-3/5/7, DAMO-CIP                      • Army Program Guidance Memorandum (APGM)—Annually mid-Jan after POM Offsite—G-8 PA&amp;E                      • Army Campaign Plan (ACP)—annually 1 Oct—HQDA, G-3/5/7, DAMO-ZT                      Research, Development, and Acquisition Plan (RDAP)—Annually March—HQDA                      Total Army Analysis (TAA)—Annually Dec—HQDA</p>
<b>Programming</b>	<p>Chairman's Program Recommendation (CPR)—Annually—CJCS                      Technical Guidance Memorandum (TGM)—Annually—HQDA                      Fiscal Guidance (FG)—Annually—OSD                      Program Objective Memorandum (POM) / Budget Estimate Submission (BES)—Annually—HQDA                      Chairman's Program Assessment (CPA)—annually—CJCS                      Issue Papers—OSD</p>
<b>Budgeting</b>	<p>Resource Management Decision (RMD)—Annually Sep to Nov—OSD                      Major Budget Issue (MBI)—Annually Dec—OSD                      Department of Defense Budget (DOD (B))—Annually Dec—OSD                      PB—Annually Jan / Feb—White House</p>
<b>Execution</b>	<p>Authorization / Appropriation—HQDA—Sep 30th                      Execution—HQDA                      Assessment—HQDA</p> <div style="display: flex; align-items: center; margin-left: 200px;"> <div style="font-size: 2em; margin-right: 10px;">}</div> <span>Continuous</span> </div>

**Figure 8-1. Department of Defense Planning, Programming, Budgeting, and Execution Phases**

### 8-6. Future Years Defense Program

a. The FYDP officially summarizes forces and resources for programs developed within the DOD PPBE process and approved by the SECDEF. The FYDP specifies force levels and lists corresponding Total Obligation Authority (TOA) and manpower. For example, in addition to historical data, the FYDP for the FY 2018 budget would show projected costs through FY 2023 as follows—

- (1) Records totals for each resource group by:
  - (a) Prior Year (PY), in this case FY 2017.
  - (b) Current Year (CY), in this case FY 2018.



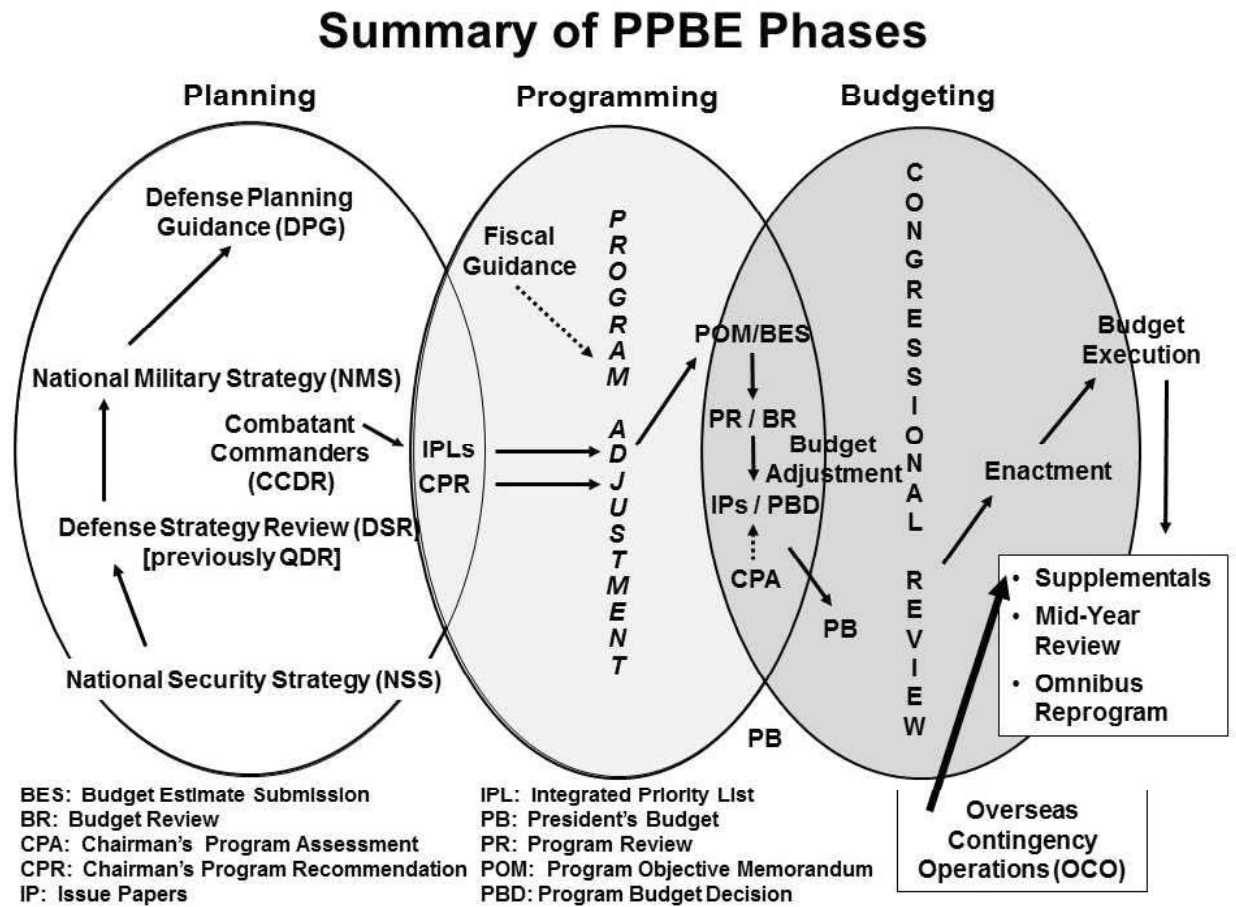

Figure 8-2. Summary of Planning, Programming, Budgeting, and Execution Phases

(c) Budget Year (BY), in this case FY 2019.

(2) Extends TOA and manpower totals 4 years beyond the FY 2018 budget to FY 2023.

(3) Extends force totals 7 years beyond the FY 2018 budget to FY 2027.

b. The FYDP comprises 11 major force programs as shown in Figure 8-3.

Table 8-1 shows these force programs with their corresponding subprograms with Army proponent agencies. Each program consists of an aggregation of program elements (PE) that reflect a DOD force or support mission. PEs identify specific activities, projects, or functions and contain the fiscal and manpower resources needed to achieve an objective or plan. PEs permit cross-service analysis by OSD and congressional staff members.

c. HQDA submits the Army portion of the FYDP database to OSD at least twice each year.

(1) The first submission, forwarded in August, records the position of the combined Army POM/BES.

(2) The second submission, forwarded in late January or early February, records the position of the PB.

d. For each FYDP position, OSD publishes a Summary and PE Detail volume on a CD ROM.

e. As prescribed by 10 U.S.C 221(a), OSD provides the PB version of the FYDP to Congress each year at or about the time the PB is submitted to Congress.

f. OSD's Director of Cost Assessment and Program Evaluation (CAPE) manages the PE data structure and serves as the approval authority for any changes to that structure. Beginning with the FY 2002-2007 POM, OSD began gradually replacing the nearly 40-year old FYDP database format with a new Defense Programming Database (DPD). Transition to the DPD is complete and has standardized budget and program data while consolidating many of the FYDP's currently required supplemental reports and annexes.

## Major Force Programs

**Program 1—Strategic Forces**

**Program 2—General Purpose Forces**

**Program 3—Command, Control,  
Communications, Intelligence (C3I)**

**Program 4—Mobility Forces**

**Program 5—Guard and Reserve Forces**

**Program 6—Research and Development**

**Program 7—Central Supply & Maintenance**

**Program 8—Training, Medical & Other General  
Personnel Activities**

**Program 9—Administrative & Associated  
Activities**

**Program 10—Support of Other Nations**

**Program 11—Special Operations Forces**

- Department of Defense (DOD) breaks the Future Years Defense Program (FYDP) into MFPs to identify forces and military capabilities
- MFPs cross service boundaries
- MFPs are dictated by DOD, but they are also used by Congress
- Each MFP is comprised of a set of unique Office of the Secretary of Defense (OSD) Program Elements (PE)

**Figure 8-3. Major Force Programs**

### 8-7. Resource Recording Structures

The FYDP accounts for the total of all resources programmed by the DOD. Using OSD PEs, DOD apportions decisions on dollars and manpower among the FYDP's 11 major force programs. See Figure 8-4 for the FYDP.

### 8-8. Key Participants

DOD key participants assisting the SECDEF in the PPBE process include the following:

- a. Deputy Secretary of Defense (DEPSECDEF). The DEPSECDEF assists the SECDEF in overall DOD leadership. He exercises authority delegated by the SECDEF and conducts the day-to-day operation of DOD. The DEPSECDEF manages the PPBE process.
- b. CJCS. The CJCS serves as the principal military adviser to the President and SECDEF and helps them provide strategic direction to the armed forces. Shouldering responsibilities for planning, advising, and policy formulation, the CJCS participates in DOD's senior councils, where he speaks for the Joint Chiefs of Staff (JCS) and CCDRs.
- c. Vice CJCS (VCJCS). The VCJCS, who is the second-ranking member of the armed forces, acts for the CJCS in his absence and chairs the Joint Requirements Oversight Council (JROC).
- d. Service Secretaries. The service secretaries convey the service perspective on DOD matters to the SECDEF and DEPSECDEF and, as key advisers, provide them with candid personal views.

# ARMY PLANNING, PROGRAMMING, BUDGETING, AND EXECUTION PROCESS

**Table 8-1. Future Years Defense Programs and Subprograms with Army Proponents**

Nr	Major Defense program	Proponent <sup>1</sup>
1.	Strategic Forces	G-3/5/7
2.	General Purpose Forces	G-3/5/7
3.	Communications, Intelligence, and Space:	
	Communications	CIO-/G-6
	Intelligence	G-2/G-3/5/7 <sup>2</sup>
	Space	SMDC <sup>3</sup>
4.	Mobility	G-3/5/7
5.	Guard and Reserve Forces:	
	Army National Guard	DARNG
	Army Reserve	CAR
6.	Research and Development	ASA (FM&C)
7.	Central Supply and Maintenance	ASA (FM&C)
8.	Training, Health and Other Personnel Activities:	
	Training	G-3/5/7
	Health	TSG <sup>4</sup>
9.	Administration	G-1
10.	Support of Other Nations	G-3/5/7
11.	Special Operations Forces	G-3/5/7

**Note:**

1. Within each applicable program, Assistant Chief of Staff for Installation Management (ACSIM) serves as proponent for base operations and real property services and G-1 serves as proponent for management headquarters and manpower functions.
2. G-2 is the resource proponent for operational and strategic intelligence. G-3/5/7 is the resource proponent for tactical intelligence.
3. U.S. Army Space and Missile Defense Command.
4. The Surgeon General.

e. Under Secretary of Defense for Acquisition, Technology, and Logistics (USD (AT&L)). The USD (AT&L) exercises responsibility for all matters relating to defense acquisition, technology, and logistics and serves as the Defense Acquisition Executive (DAE).

f. Under Secretary of Defense for Policy (USD (P)). The USD (P) represents DOD on foreign relations and arms control matters and serves as the principal adviser to the DEPSECDEF for the PPBE planning phase.

g. Under Secretary of Defense (Comptroller) (USD (C)). The USD (C) exercises responsibility for all budgetary and fiscal matters.

h. Under Secretary of Defense (Personnel and Readiness) (USD (P&R)). The USD (P&R) exercises responsibility for all matters relating to total force management as it concerns readiness, National Guard and Reserve Affairs, health affairs, training, and personnel requirements and management.

i. Director, CAPE. The Director, CAPE serves as the principal staff assistant to the SECDEF for cost assessment and program evaluation.

## Future Years Defense Program

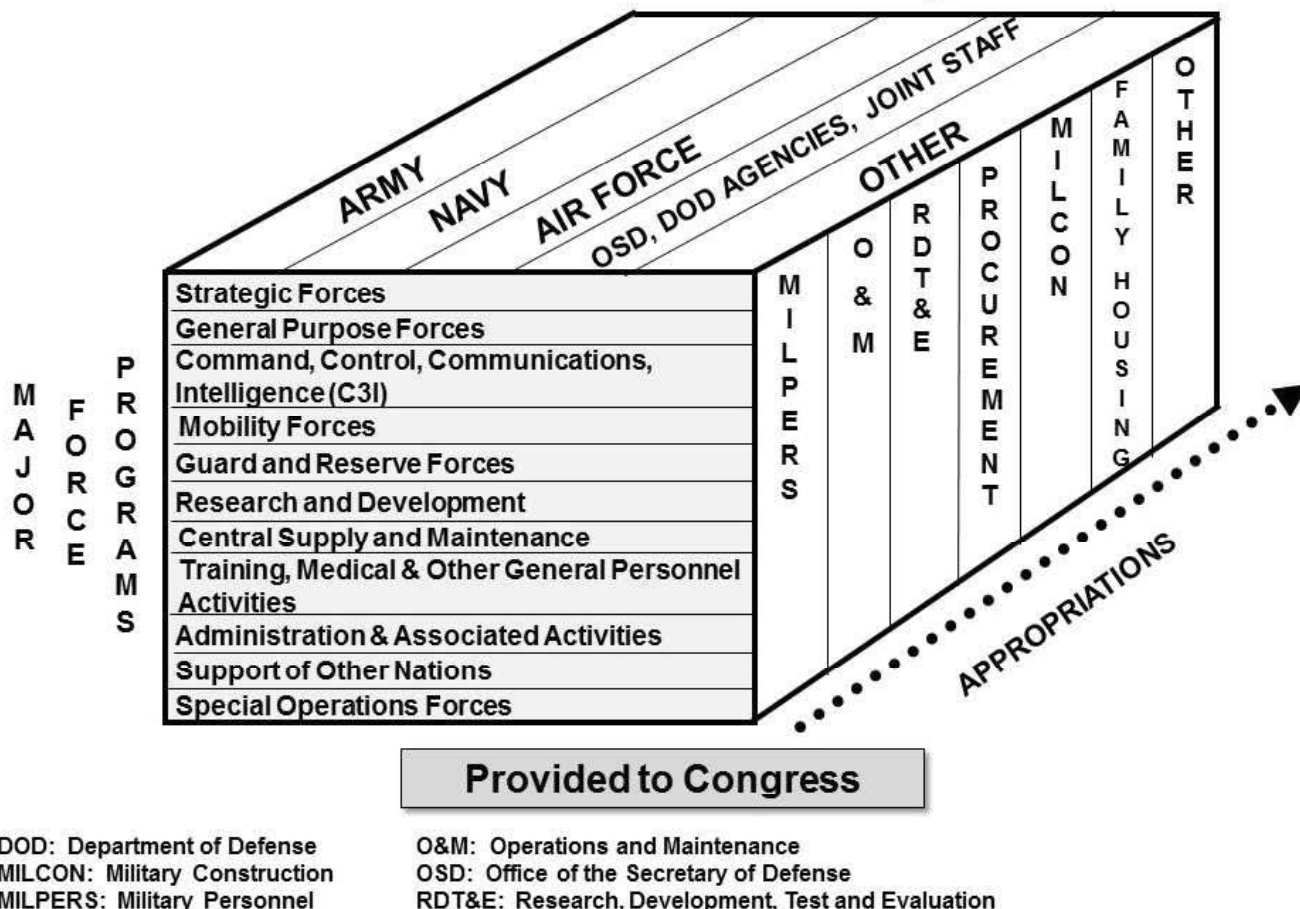

**Figure 8-4. Future Years Defense Program**

### 8-9. Decision Bodies

Several groups have been organized to assist the SECDEF in making PPBE resource decisions as shown in Figure 8-5. These groups counsel the SECDEF in applying sound business practices in the military departments, DOD agencies, and other DOD components. When determined by the chair, heads of other DOD components participate as appropriate. For example, the chair may invite officials to participate from other departments and agencies of the executive branch, including the Office of Management and Budget (OMB) and the NSC. The groups are—

- a. Secretary's Senior Leadership Council (SSLC). The SSLC is the senior information exchange body in the DOD resource management system. The SECDEF chairs the SSLC. Membership includes the Deputy's Management Action Group (DMAG) principals and CCDRs.
- b. Senior Leader Review Group (SLRG). The SLRG is the senior decision-making body assisting the SECDEF and DEPSECDEF in making major program decisions. The SECDEF chairs the SLRG with the CJCS serving as vice chairman. The DEPSECDEF designates other OSD principals to participate in deliberations as necessary. SLRG members include—
  - (1) From OSD: DEPSECDEF; USD (C); USD (P); USD (AT&L); USD (P&R); Under Secretary of Defense for Intelligence (USD (I)); Director, CAPE; Assistant Secretaries of Defense for Legislative Affairs, Public Affairs and Networks and Information Integration, and CCDRs.
  - (2) From the joint staff (JS) and services: CJCS; VCJCS; Director, JS; secretaries of the military departments (MILDEPS) who are normally accompanied by service chiefs; and Chief of the National

## ARMY PLANNING, PROGRAMMING, BUDGETING, AND EXECUTION PROCESS

Guard Bureau (CNGB). Considering broad policy and developing guidance on high-priority objectives, the SLRG helps promote long-range planning and stability in the defense program.

(3) Among other functions, the SLRG—

(a) Reviews guidance for planning and programming.

(b) Evaluates high-priority programs.

(c) Considers the effect of resource decisions on baseline cost, schedule, and performance of major acquisition programs and aligns the programs with the PPBE process.

(d) Helps tie the allocation of resources for specific programs and forces to national policies.

(e) Reviews the program and budget.

(f) Reviews execution of selected programs.

(g) Advises the SECDEF on policy, PPBE issues, and proposed decisions.

(4) When the SLRG meets to deliberate major issues on DOD-funded intelligence programs, it expands to include representatives of appropriate intelligence agencies. The DEPSECDEF and Director of Central Intelligence co-chair this expanded SLRG (ESLRG).

(5) The Director, CAPE, acts as executive secretary for both the SLRG and ESLRG. In this capacity, the director manages the program review process and, with the chairs of the ESLRG, the intelligence program review. The Director, CAPE, also manages the preparation of issue papers (IP) to formulate service-level issues which challenge the service program requests and the intelligence RMDs (IRMD) that reflect the SECDEF's program decisions.

c. Deputy's Management Action Group (DMAG). The DMAG facilitates the development of the QDR, monitors its implementation, and addresses other subjects as required. The DMAG participates in the program review process and comments on the IPs resulting from the program review of the POM. The DEPSECDEF and VCJCS co-chair the DMAG.

(1) DMAG membership is as follows:

(a) From OSD: USD (AT&L); USD (C); USD (P&R); and USD (I); Deputy Undersecretary for Policy; Assistant Secretary Defense Network Integration / CIO; Director and Principal Deputy Director, Cost Assessment & Program Analysis; Director Administration and Management; Assistant Secretary of Defense, Legislative Affairs; and the General Counsel.

(b) From the JS and Services: service undersecretaries and vice chiefs; Director, JS; Director, J-8; Director, J-5; Director, National Guard Bureau; and Deputy Commander, U.S. Special Operations Command (USSOCOM). CCDRs or their deputies are welcome when issues are being considered that impact their regional or functional responsibilities.

(2) The DMAG generally meets weekly to consider ongoing and cyclic issues including:

(a) Capability portfolio development and management.

(b) Defense planning scenarios and related analytical efforts.

(c) Program and budget reviews.

(d) IPs resulting from the OSD staff and other players.

(e) Strategy and policy development including periodic reviews.

(f) Regional and functional challenges.

(g) Transformation.

d. The OSD 3-star programmers group analyzes major issues and develops decision options during program review. It forwards issues sufficiently significant to warrant action by the SLRG to that body for consideration. Supporting the endeavor, OSD principal staff assistants conduct a series of front end assessments (FEA). As directed by the SLRG, assessments address topics or decisions that will influence the next POM and subsequent program review. Prepared in coordination with other OSD principal assistants, representatives of the CJCS, and service chiefs, the assessments are briefed to the 3-star group. As appropriate, they are also briefed to the DEPSECDEF or SLRG. The Director, Cost Assessment and Program Analysis, chairs the 3-star group. Adding other OSD principals to participate in sessions as appropriate, the 3-star group includes the following members:

(1) From OSD: Representatives from the Deputy Under Secretary of Defense (Comptroller, Policy, Intelligence, and Acquisition, Technology, and Logistics) and the Assistant Secretaries of Defense for Force Management Policy, Health Affairs, and Reserve Affairs, the Principal Deputy Assistant Secretary of Defense for Networks and Information Integration, the Director of Operational Test and Evaluation and Commander USSOCOM.

(2) From the JS: Director for Force Structure, Resources, and Assessment (J-8).

(3) From the services: HQDA DCS G-8; Deputy Chief of Naval Operations (Resources, Warfare Requirements and Assessments); Marine Corps Deputy Commandant (Programs and Resources); and Air Force, DCS (Plans and Programs).

## DOD Review / Decision-Making Bodies

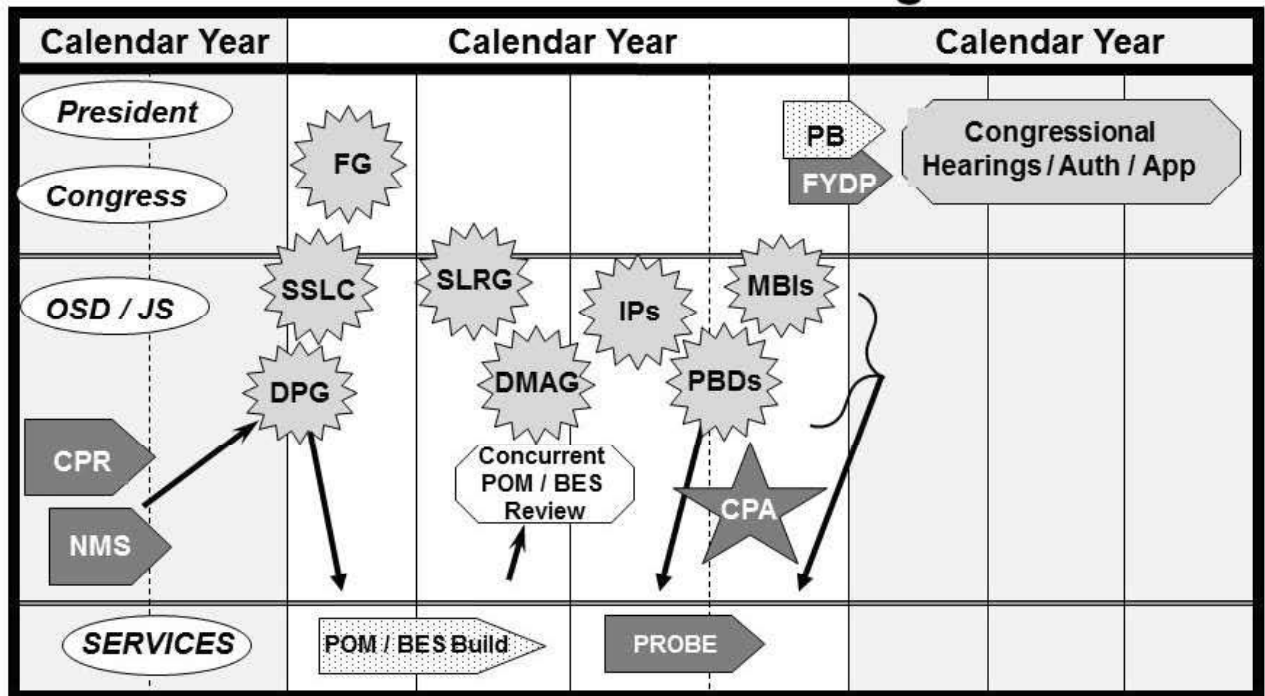

- BES: Budget Estimate Submission
- CPA: Chairman's Program Assessment
- CPR: Chairman's Program Recommendation
- DMAG: Deputy's Management Action Group
- DPG: Defense Planning Guidance
- FG: Fiscal Guidance
- FYDP: Future Years Defense Program
- IP: Issue Paper
- JS: Joint Staff
- MBI: Major Budget Issue
- NMS: National Military Strategy
- OSD: Office of the Secretary of Defense
- PB: President's Budget
- POM: Program Objective Memorandum
- PROBE: Program Objective & Budget Execution
- PBD: Program Budget Decision
- SSLC: Secretary's Senior Leadership Council
- SLRG: Senior Leader Review Group

Figure 8-5. Department of Defense Review / Decision-Making Bodies

### 8-10. Intelligence Program Review Group

- a. The Intelligence Program Review Group (IPRG) identifies opportunities to advance the U.S. Government's intelligence strategy. It evaluates potential program changes from a mission perspective, considers tradeoffs, and forwards issue analyses to the ESLRG for consideration.
- b. The Director, CAPE, and the Executive Director for Intelligence Community Affairs co-chair the IPRG. Members include representatives of all executive branch organizations that manage or oversee intelligence capabilities.

### 8-11. Defense Acquisition Board and Joint Requirements Oversight Council

- a. The USD (AT&L), with the Defense Acquisition Board and Joint Requirements Oversight Council (JROC), help link the acquisition process to planning, programming, and budgeting. Serving as a key adviser to the SECDEF and DEPSECDEF, the USD (AT&L) participates in all resource decisions affecting the baselines of major acquisition programs, including costs, schedules, and performance.
- b. The JROC helps forge consensus underlying the CJCS's statutory advice to the SECDEF on program and budget proposals. The JROC also helps the Director of the Army Budget (DAB) and USD

(AT&L) articulate military needs and validate performance goals and program baselines at successive milestones of each DAB program.

- c. For more detail on the JROC, see Chapter 10.

## Section III

### The Army Planning, Programming, Budgeting, and Execution Process

#### 8-12. Army's Primary Resource Management System

The PPBE process serves as the Army's primary resource management process. A major decision-making process, PPBE interfaces with joint strategic planning and with planning conducted by OSD. Linking directly to OSD programming and budgeting, the PPBE process develops and maintains the Army portion of the defense program and budget. PPBE supports Army planning, program development, and budget preparation at all levels of command. Similarly supporting program and budget execution, it provides feedback to the planning, programming, and budgeting processes.

#### 8-13. Planning, Programming, Budgeting, and Execution Concept

- a. The PPBE process ties strategy, program, and budget all together. It helps build a comprehensive plan in which budgets flow from programs, programs from requirements, requirements from missions, and missions from national security objectives. The patterned flow from end purpose to resource cost defines requirements in progressively greater detail.

- b. Long-range planning creates a vision of the Army 20 years into the future. In the 2- to 10-year mid-term, long-range macro estimates give way to a specified size, composition, and quality of operational and support forces. Derived from joint strategic planning and intermediate objectives to achieve long-range goals, this operational and support force provides the planning foundation for program requirements.

- c. In the mid-term, guided by force requirements, the integrated program-budget process distributes projected resources. It seeks to support priorities and policies of the senior Army leadership while achieving balance among Army organizations, systems, and functions. For the 0- to 2-year near-term, the integrated process converts program requirements into budget requests for manpower and dollars. When enacted into appropriations and manpower authorizations, these resources become available to carry out approved programs.

- d. By formally adding execution to the traditional emphasis on planning, programming, and budgeting, the Army emphasizes concern for how well program performance and financial execution apply allocated resources to meet the Army's requirements.

- e. Documents produced within the PPBE process support defense decision-making, and the review and discussion that attend their development help shape the outcome. For example—

- (1) The Army helps prepare the SECDEF's Defense Planning Guidance (DPG) and planning documents produced by the Joint Strategic Planning System (JSPS). Army participation influences policy, strategy, and force objectives considered by the SECDEF and the CJCS, including policies for development, acquisition, and other resource-allocation issues.

- (2) ACOM commanders, PEOs, and heads of other operating agencies similarly influence positions and decisions taken by the SECARMY and CSA. Commanders and heads of agencies develop and submit force structure, procurement, and construction requirements as well as assessments and data to support program and budget development. Through periodic commanders' conferences held by the CSA, they also make their views known on the proposed plan, program, and budget.

- (3) CCDRs influence Army positions and decisions through ACOM commanders serving as commanders of ASCCs, who integrate operational requirements of the CCMD into their program and budget submissions. CCDRs also highlight requirements in an IPL that receives close review during program development.

#### 8-14. Planning, Programming, Budgeting, and Execution Objectives

The main objective of the PPBE process is to establish, justify, and acquire the fiscal and manpower resources needed to accomplish the Army's assigned missions in executing the NMS. Phase by phase objectives follow—

- a. Conduct planning to size, structure, man, equip, train, and sustain the Army force to support the NMS.
- b. Analyze integrated programming and budgeting, to—
  - (1) Distribute projected manpower, dollars, and materiel among competing requirements according to Army resource allocation policy and priorities, making sure that requirements get resourced at defensible, executable levels.
  - (2) Convert resource allocation decisions into requests for congressional authorization and appropriations.
- c. Execute programs to apply resources to achieve approved program objectives, and adjust resource requirements based on execution feedback.
- d. Oversee budget execution, to manage and account for funds to carry out approved programs.

### **8-15. Control of Planning, Programming, and Budgeting Documents**

- a. Papers and associated data sponsored by the DOD PPBE process give details of proposed programs and plans. The proposals often state candidate positions and competing options that remain undecided until final approval.
- b. Access to such tentative material by other than those directly involved in planning and allocating resources would frustrate the candor and privacy of leadership deliberations. Moreover, access by private firms seeking DOD contracts would imperil competition and pose serious ethical, even criminal, problems for those involved. For these reasons, DOD closely controls documents produced through the DOD PPBE process and its supporting databases. Thus, OSD restricts access to DOD and other governmental agencies directly involved in planning, programming, and budgeting Defense resources, primarily OMB.
- c. Exceptions to the limitations described require SECDEF approval. After coordination with the General Counsel, Army proponents may request an exception, but only for compelling need. Statutes and other procedures govern disclosure of information to Congress and the General Accountability Office (GAO).
- d. Guidance in DODD 7045.14 gives the secretaries of the MILDEPS, CJCS, the Under Secretaries and Assistant Secretaries of Defense, Director, CAPE, and the Director, Operational Test and Evaluation designation as the approval authorities for disclosing PPBE documents and data outside the DOD and to other government agencies directly involved in the defense planning and resource allocation process. This disclosure authority is restricted to PPBE documents and data generated by the offices and organizations they oversee.
- e. Major PPBE and PPBE-related documents and material requiring restricted access include--
  - (1) Planning Phase:
    - (a) Defense Planning Guidance (DPG)
    - (b) Guidance for Employment of Forces (GEF)
    - (c) The Army Plan (TAP)
  - (2) Programming Phase:
    - (a) Fiscal Guidance.
    - (b) POM.
    - (c) FYDP documentation including FYDP annexes.
    - (d) IPs (for example, major IPs, and cover briefs).
    - (e) Proposed MILDEP program reductions (or program offsets).
    - (f) Tentative issues in the form of draft IPs process at OSD.
  - (3) Budgeting Phase:
    - (a) FYDP documents for the BES and PB, including procurement, RDT&E, and construction annexes.
    - (b) RMD which are implementing instructions from the SECDEF on his final decisions on programs.
    - (c) Automated Program and Financing Statements.
    - (d) Reports generated by the automated CIS.
    - (e) DD Form 1414, Base for Reprogramming Actions.
    - (f) DD Form 1416, Report of Programs.
    - (g) Congressional data sheets.
    - (h) Management Initiative Decisions (MID).



**Section IV**

**Leading Army Planning, Programming, Budgeting, and Execution System Phases**

**8-16. Secretarial Oversight**

- a. Responsible for PPBE oversight and Army-wide policy development, the Assistant Secretary of the Army (Financial Management and Comptroller) (ASA (FM&C))—
  - (1) Oversees the PPBE process and develops and issues Army-wide PPBE policy.
  - (2) Serves as appropriation sponsor for all appropriations (funds) except Army National Guard (ARNG) and U.S. Army Reserve (USAR) appropriations, whose sponsors are the CNGB and Chief, Army Reserve (CAR).
- b. Functional Oversight. Principal officials of the Office of the Secretary of the Army (OSA) oversee operation of the PPBE process within assigned functional areas and provide related policy and direction.

**8-17. System Management**

ASA (FM&C) manages the PPBE process, with the HQDA DCS G-3/5/7, Director, Program Analysis and Evaluation (DPAE), and Military Deputy for Budget and Execution acting as advisers. The Assistant Deputy Chief of Staff (ADCS) G-3/5/7, the DPAE, and the DAB manage functional phases of the process, each establishing and supervising policies and procedures necessary to carry out phase functions.

**8-18. Planning Phase**

- a. HQDA DCS G-3/5/7. Responsible for operations and planning functions with the Assistant Deputy G-3/5/7, as follows—
  - (a) Manages the PPBE planning phase.
  - (b) Co-chairs the Planning Program Budget Committee (PPBC) with the DPAE and DAB.
  - (c) With the Military Deputy for Budget, OASA (FM&C) and the G-8, co-chair the Three-Star Budget, Requirements, and Program Board (BRP).
  - (d) Guides the work of Program Evaluation Groups (PEG) on planning and readiness matters to include requirements determination, prioritization, and the integration of security cooperation issues per the Army International Activities Plan (see Table 8-2).

**Table 8-2. Managers for Manpower and Force Structure Issues**

Issue	Manager
Force structure/Unit Identification Code (UIC)/Resource Organization (Command) Code (ROC)	G-3/5/7
Military Manpower (Active)	G-1
Army National Guard Manpower	Director ARNG
U.S. Army Reserve Manpower	Chief AR
Civilian (End Strength and Full Time Equivalents)	G-1
Individuals Account	G-1
Army Management Headquarters Activities (AMHA)	G-1
Joint and Defense Accounts	G-1

The functional proponents outlined above and their supporting PEGs bear responsibility for setting the funding level of validated military requirements and validating and funding nonmilitary requirements generated by new equipment for unit set fielding, force modernization, or other new mission or doctrine.

- (e) Assesses capabilities, deficiencies, and risks of the POM force at the end of the current POM.
  - (2) Serves as the principal adviser to the Chief of Staff, Army (CSA) on joint matters, NSC matters, and the politico-military aspects of international affairs, as follows—
    - (a) Provides HQDA with strategic analysis pertaining to national security issues involving international and regional arms control treaties, agreements, and policies.
    - (b) Plans for employment of Army forces to meet strategic requirements and shape Army forces for the future.
    - (3) Serves as overall integrator of Army transformation, as follows—

(a) Makes sure that military requirements reflect future Army Strategic Plan (ASP), other planning guidance, and policy, and that the capability and applicability of total Army forces remain synchronized with the NSS, national defense strategy, and National Military Strategy (NMS).

(b) Provides the HQDA focal point for the organization, integration, and synchronization of decision making, as well as for requirements definition, force structuring, training developments, and prioritization.

(4) Prepares the Army Vision (AV), ASP, Army Planning Guidance (APG), and Army Campaign Plan (ACP) sections of The Army Plan (TAP); coordinates the publication of the Army Program Guidance Memorandum (APGM) with the DPAE. In addition—

(a) Defines Army planning assumptions.

(b) Sets requirements and priorities based on guidance from the SECDEF, Secretary of the Army (SECARMY), and CSA and priorities of the CCDRs.

(c) Sets objectives to meet requirements and overcome shortfalls.

(5) Monitors and reports on current operations as follows—

(a) Develops and coordinates policy, programs, and initiatives to achieve directed levels of individual, leader, and unit training readiness for the Army.

(b) Oversees Army readiness reporting requirements and the reporting of Army readiness to provide an accurate picture for prioritization and resource allocation decisions within HQDA and externally.

(c) Assesses and coordinates support to CCDRs and, through the Army Service Component Command (ASCC), provides the operational link between each combatant command (CCMD), HQDA, and the JS.

(6) Performs all mobilization functions.

(7) Provides the HQDA focal point for executing military support to civil authorities.

(8) Executes the Continuity of Operations Program (COOP) for HQDA and OSD, the Army Infrastructure Assurance Program, and the Domestic Preparedness Program which provides support for special events.

(9) Provides support for special events.

(10) Provides the vision and strategy and manages the development of models and simulations.

(11) Develops policy and acts as the principal adviser to the CSA for information operations.

(12) Serves as proponent of the Training PEG.

(13) Serves as proponent of programs within the FYDP, including: 1-Strategic Forces, 2-General Purpose Forces, 4-Mobility, 10-Support of Other Nations, and 11-Special Operations Forces.

(14) Serves as resource proponent for tactical intelligence, Army subprogram 3-Intelligence and proponent of Army subprogram 8-Training.

(15) Manages force structure issues and manages functional requirements and program and performance for designated accounts of the Operation and Maintenance, Army (OMA) appropriation (see Tables 8-8 through 8-14).

b. HQDA DCS G-8. Responsible for the execution of approved materiel requirements, as follows—

(1) Provides the HQDA focal point for program development, materiel integration, and assessments like the QDR [renamed DSR].

(2) With the ASA (ALT), prepares the Research, Development, and Acquisition Plan (RDAP), which is represented by the database for the FYDP augmented for the extended planning period (EPP).

(3) Prepares the Army's Equipment Modernization Strategy (AEMS), the Army Equipment Program in support of the PB, the Army Equipping Guidance and helps prepare Army input to OSD's Defense Program Projection.

(4) Serves as proponent of the Equipping PEG.

(5) With the Military Deputy for Budget, OASA (FM&C) and the G3/5/7, co-chair the Three-Star Budget, Requirements, and Program Board.

(6) Manages functional requirements for Research, Development, Test, and Evaluation (RDT&E) and procurement appropriations.

### **8-19. Integrated Programming and Budgeting Phase**

The DPAE and DAB jointly manage the integrated programming and budgeting phase to produce a combined POM and Budget Estimate Submission (BES).

a. DPAE. The Army DPAE takes the lead on programming matters and—

(1) Provides the SECARMY and CSA with independent assessments of program alternatives and priorities.

(2) Provides analytical and administrative support for PPBE forums.

## ARMY PLANNING, PROGRAMMING, BUDGETING, AND EXECUTION PROCESS

- (3) Co-chairs the PPBC and the Two-Star BRP with the ADCS G-3/5/7 and the DAB.
- (4) Exercises overall responsibility at HQDA for Army program development in support of the POM and FYDP.
- (5) With the ADCS G-3/5/7 and DAB, guides and integrates the work of PEGs throughout the PPBE process.
- (6) With functional proponents—
  - (a) Prepares Army responses to OSD programming guidance documents.
  - (b) Structures the APGM and Technical Guidance Memorandum (TGM) to articulate direction and guidance from the DPG and senior Army leadership.
  - (c) Develops the Army program, including review of CCDR integrated priority lists (IPL) and program submissions of the Army Commands (ACOM), Program Executive Offices (PEO), and other operating agencies.
  - (7) Codifies and submits to OSD the approved Army program in the POM.
  - (8) Serves as HQDA point of contact for the POM and FYDP within HQDA, and with OSD and the JS.
  - (9) Manages the management decision execution packages (MDEP) architecture.
  - (10) Serves as host activity manager of the PPBE enterprise system in coordination with ASA (FM&C), appropriation sponsors, manpower managers, the OSD Comptroller, OSD Director, CAPE, and Department of the Treasury, and—
    - (a) Through the PPBC, establishes a PPBE Strategic Automation Committee (PSAC) to implement configuration management of the PPBE enterprise system and oversee long-term plans for investing in information technology (IT) to improve the performance of PPBE functions.
    - (b) Maintains the resource management architecture for automated support of PPBE processes and information systems and their integration into a common PPBE database. In particular: hosts the web services that provide coordination for the common data architecture, including PEs, Army PE (APE), resource organization (command) codes, the SSN-LIN Automated Management and Integrating System (SLAMIS) and, in coordination with the Defense Finance and Accounting Service (DFAS), the Army Management Structure Code (AMSCO); maintains an integrated data dictionary of data elements in the PPBE data element structure and disciplines its use without re-keying by database users and component databases; and controls data entry and makes sure that PPBE data elements are consistent not only internally for programming, budgeting, and execution but, also externally with reporting requirements of the Standard Data Collection System (SDCS), Service Support Manpower System (SSMS), and Comptroller Information System (CIS) or their successors.
    - (c) Maintains the official database position for Army Program and Budget Guidance (PBG) and through the SDSCS, SSMS, and CIS, or their successors, updates OSD resource management databases with data that reflect the POM, BES, and the PB. Affected data includes the Army BES for manpower, Army appropriations, and Army-managed defense appropriations.
    - (d) Ensures that the Army portion of FYDP submissions to OSD includes defense appropriations managed by the Army and that force structure and manpower information match positions in the force structure and accounting databases for the Active Army, ARNG, USAR, and civilian work force.
    - (e) Issues the PBG to the Army Commands, PEOs, PMs, and other operating agencies and Direct Reporting Units (DRUs) after each PPBE phase.
  - (11) Provides feedback to each CCDR as to the resource status of the command's issues on forwarding the combined POM / BES to OSD.
- b. DAB. The DAB takes the lead on budgeting matters and:
  - (1) Co-chairs the PPBC and the Two-Star BRP with the ADCS G-3/5/7 and DPAE.
  - (2) Establishes budgeting policy and processes.
  - (3) Guides and integrates the work of the PEGs on budget matters.
  - (4) Reviews and consolidates the ARNG and USAR budgets with the Active Army budget.
  - (5) Provides feedback to each CCDR on major budget issues (MBI) affecting the command's resource requirements.
  - (6) Justifies the Army budget before OSD, OMB, and Congress.
  - (7) Maintains liaison and acts as point of contact with Congressional appropriations committees except for civil works issues.
  - (8) With the DPAE and data proponents, performs system and data management functions.

- (9) Serves as proponent of FYDP program 6-Research and Development and program 7-Central Supply and Maintenance.
- (10) Manages functional requirements and program and performance for designated appropriation accounts.
- (11) Manages the data architecture of APE and elements of resource (EOR).
- (12) Maintains and issues TOA controls for Army appropriations for the BES and the PB cycles.
- (13) Translates final budget decisions into program changes, posting PEs, Army PEs (APE), MDEPs, and command distributions, as required, updating the PPBE database to produce the PB position submitted to OSD and Congress.
- (14) Manages the issue cycle to formulate IPs challenging the Service program requests and MBI processes. The IPs from the SECDEF challenge the service program requests with suggested changes.
  - (a) Maintains coordination between the USD (C) and HQDA.
  - (b) Makes sure that adjustments to fiscal controls are correct on all records for each IP (verifying corresponding manpower controls, however, is a HQDA DCS G-1 responsibility).
  - (15) Gives special attention to any IP under appeal since the DEPSECDEF may, on review, revise pending adjustments.
- (16) When the SECDEF makes his final decision on change to the Service programs he issues RMDs which directs the Services to change their programs to comply with his resourcing decisions.
  - c. ADCS G-3/5/7. The ADCS G-3/5/7 ensures the optimal allocation of army resources by evaluating the integrated programming-budgeting phase for compliance with The Army Plan (TAP) and Army priorities. Additionally, Co-chairs the PPBC and the Two-Star BRP with the DAB and DPAE.

### 8-20. Execution Phase

- a. Military Deputy for Budget and Execution. For the ASA (FM&C), the Military Deputy for Budget and Execution—
  - (1) Reviews program performance and, specifically, oversees Cost and Performance Measures designed to provide the senior Army leadership with a corporate view of business efficiencies and program accomplishment.
  - (2) Applies funds appropriated by Congress to carry out authorized programs.
  - (3) Through the DAB, manages the PPBE execution phase.
- b. DAB. The DAB manages the PPBE Execution phase and, during financial execution—
  - (1) Establishes funding policy and processes.
  - (2) Supervises and directs financial execution of the congressionally approved budget.
  - (3) Allocates funds appropriated by Congress and monitors their execution
  - (4) Oversees accounting for and reporting on use of Army-managed funds to OSD and Congress by appropriation. As applicable to each appropriation, includes FYDP program, PEs, APEs, project number, budget line item number (BLIN), Standard Study Number (SSN), quantities, budget activity groups (BAG), activity groups (AG), budget sub-activity groups (SAG), element of resource (EOR), and financing data. Also as applicable to an appropriation, accounts for and reports on the use of the manpower-by-manpower category.
  - (5) With functional proponents and within stated restrictions and specified dollar thresholds, reprograms funds as required to meet unforeseen requirements or changes in operating conditions.
  - (6) With the Defense Finance and Accounting Service (DFAS):
    - (a) Oversees the development and maintenance of standard Army systems in support of financial accounting; and oversees implementation of the same standard Army systems in support of distribution, accounting, and reporting of funds.
    - (b) Makes sure that execution reports meet HQDA management information needs.
  - c. DPAE. During programmatic execution, the DPAE monitors how programmed resources are applied to achieve approved objectives to gain feedback for adjusting resource requirements.
  - d. The ADCS G-3/5/7. The ADCS G-3/5/7 ensures the optimal allocation of Army resources by evaluating the execution phase for compliance with TAP and Army priorities.

**Section V**

**Supporting Responsibilities in the Army for Planning, Programming, Budgeting, and Execution System**

**8-21. Headquarters Department of the Army Principal Officials**

- a. The Assistant Secretary of the Army (Acquisition, Logistics, and Technology) (ASA (ALT))—
  - (1) Represents the Army on the DAB, the Nuclear Weapons Council Standing Committee, and the Conventional Systems Committee.
  - (2) Integrates the development and acquisition of materiel into all phases of the PPBE process.
  - (3) With the HQDA DCS G-8, helps prepare the Research, Development, and Acquisition Plan (RDAP).
  - (4) Manages functional requirements and program and performance for RDT&E and procurement appropriations, the Chemical Agents and Munitions Destruction, Army appropriation, and designated miscellaneous accounts, as well as the contract operations account of the Operation and Maintenance, Army (OMA) appropriation.
- b. The Assistant Secretary of the Army (Installations, Energy and Environment) (ASA (IE&E)) exercises responsibility for, and oversees, all matters and policy related to installations, housing, installation-related-military construction, real estate and environment, safety, and occupational health.
- c. The Assistant Secretary of the Army (Manpower and Reserve Affairs ((ASA (M&RA))—
  - (1) Oversees Army manpower requirements determination and resource allocation for all Army components across all major Army Commands (ACOM) and separate agencies (Active, Guard, Reserve, Joint, and Defense).
  - (2) Reviews policies and programs pertaining to readiness, resource allocation, training, force structure, and professional and leader education and development.
- d. Administrative Assistant to the Secretary of the Army (AASA)—
  - (1) Plans, programs, budgets, and accounts for the execution of resources for HQDA and its field operating and staff support agencies.
  - (2) Serves as proponent of the Organizing PEG.
- e. Chief Information Officer and Army G-6 (CIO / G-6)—
  - (1) Serves as Program Integrator for IT.
  - (2) Serves as proponent of the Army FYDP subprogram 3-Communications.
  - (3) Makes sure through advice and technical assistance that Army acquires IT and manages information resources in a manner that implements the policies, procedures, and goals of the Army Knowledge Management Strategic Plan.
  - (4) Validates IT requirements and monitors the performance of IT programs throughout all phases of the PPBE process.
  - (5) Develops, maintains, and facilitates the IT architecture, the Army Knowledge Enterprise Architecture (AKEA), across the Army.
- f. HQDA DCS G-1—
  - (1) Develops human resource programs, budgets, and activities to execute life-cycle functions of manning, well-being, personnel technologies, Soldier-oriented R&D, and personnel transformation.
  - (2) Serves as proponent of the Manning PEG.
  - (3) Serves as proponent of FYDP program 9-Administration.
  - (4) Manages issues related to Army manpower accounts except for ARNG and USAR manpower and manages functional requirements and program and performance for the military pay, Army appropriation, and for designated personnel accounts and manpower-only accounts of the OMA appropriation.
- g. HQDA DCS G-2—
  - (1) Prepares, justifies, and submits the program and budget for the Army portion of the National Foreign Intelligence Program (NFIP) per the policy, resource, and administrative guidance of the Director of Central Intelligence and DOD NFIP Program Managers. The Director of Central Intelligence is also responsible under statute and presidential order to do the following: develop, approve, and present to POTUS an annual budget for the NFIP for inclusion in the PB for transmittal to Congress pursuant to OMB guidance; and participate in the development by the SECDEF of the annual budgets for the Joint Military Intelligence Program (JMIP) and the Tactical Intelligence and Related Activities (TIARA).
  - (2) Serves as Army Staff lead for integrating intelligence, surveillance, and reconnaissance (ISR) matters into all phases of the PPBE process.

## HOW THE ARMY RUNS

(3) Serves as the resource proponent for operational and strategic intelligence of Army FYDP subprogram 3-Intelligence.

(4) Manages functional requirements and program and performance for Security Programs of the OMA appropriation.

(5) Serves as PEG Program Integrator for national and military intelligence program matters

h. HQDA DCS G-4—

(1) Develops and resources Army-wide logistics operation programs for strategic mobility, supply, maintenance, war reserves and prepositioning, aviation, munitions, transportation, distribution, readiness, and integrated logistics support (ILS).

(2) Integrates and balances between acquisition and logistics the sustainment functions of readiness, supply, services, maintenance, transportation, aviation, munitions, security assistance, and related automated systems.

(3) On behalf of the AAE—

(a) Develops policies for, and oversees, the PPBE of ILS.

(b) Makes sure that PEOs have programmed and incorporated supportability requirements into the acquisition and fielding of new systems.

(4) Serves as proponent of the Sustaining PEG.

(5) Manages functional requirements for the Procurement of Ammunition, Army appropriation and the Army Working Capital Fund and manages functional requirements and program and performance for Logistics Operations accounts of the OMA appropriation, including those for base operations.

i. Assistant Chief of Staff for Installation Management (ACSIM)—

(1) Develops and directs planning, programming, and budgeting of installation management functions and the funding of installation-related military construction, housing, environmental protection, and facilities operation and sustainment.

(2) Provides ACSIM validation of requirements for managing and funding Army installations.

(3) Serves as proponent of the Installations PEG.

(4) Manages functional requirements and program and performance for military construction appropriations and environmental restoration as well as Installation Management Operations and Maintenance appropriations.

j. Chief of Engineers (COE)—

(1) Supports and promotes resource requirements of the engineer regiment.

(2) Represents and promotes resource requirements of the U.S. Army Corps of Engineers (USACE).

(3) Acts for SECARMY in executing SECARMY Executive Agent responsibilities for military construction to include construction for the Air Force, Navy, National Aeronautics and Space Administration (NASA), and selected DOD activities and foreign nations.

(4) Manages functional requirements and program and performance for the Homeowners Assistance Fund, Defense.

k. The Surgeon General (TSG)—

(1) Represents and promotes resource requirements of the U.S. Army Medical Department.

(2) Manages functional requirements and program and performance for reimbursable medical manpower of the OMA appropriation.

l. Chief, National Guard Bureau (CNGB). Through the Director of the Army National Guard (DARNG)—

(1) Plans and administers the budget of the ARNG and serves as appropriation sponsor for ARNG appropriations.

(2) Serves as proponent of the ARNG subprogram, FYDP program 5-Guard and Reserve Forces.

(3) Manages ARNG manpower issues and manages functional requirements and program and performance for ARNG appropriations and ARNG accounts of the Operation and Maintenance, Army National Guard appropriation.

(4) Serves as Program Integrator for the statutory, defense, and Army requirements of the ARNG.

(5) Provides technical assistance to Title 10 PEGs and monitors actions to integrate into all phases of the PPBE processes the statutory, defense, and Army requirements of the ARNG.

(6) Tracks ARNG program performance during budget execution.

m. CAR—

(1) Plans and administers the budget of the USAR and serves as appropriation sponsor for USAR appropriations.

(2) Serves as proponent of the USAR subprogram, FYDP program 5-Guard and Reserve Forces.

# ARMY PLANNING, PROGRAMMING, BUDGETING, AND EXECUTION PROCESS

- (3) Manages USAR manpower issues and manages functional requirements and program and performance for USAR appropriations and USAR accounts of the Operation and Maintenance, U.S. Army Reserve appropriation.
- (4) Serves as Program Integrator for the statutory, defense, and Army requirements of the USAR.
- (5) Provides technical assistance to Title 10 PEGs and monitors actions to integrate into all phases of the PPBE processes the statutory, defense, and Army requirements of the USAR.
- (6) Tracks USAR program performance during budget execution.

## 8-22. Army Commanders

- a. Commanders of ACOMs, PEOs, and heads of other operating agencies:
  - (1) Plan, program, and budget for assigned missions, responsibilities, and functions.
  - (2) Document manpower in their subordinate organizations per allocated manpower levels.
  - (3) Execute the approved ACOM or agency program within allocated resources, applying the inherent flexibility allowed by law and regulation.
  - (4) Assess ACOM or agency program performance and budget execution and—
    - (a) Account for and report on use of allocated funds by appropriation and MDEP. As applicable to each appropriation, include FYDP program, Army Management Structure Code (AMSCO), Army Program Element (APE), project number, BLIN, SSN, BA, BAGs, AGS, SAGS, and EOR. Also account for and report on use of allocated manpower by unit identification code (UIC).
    - (b) Use manpower data and financial data from budget execution in developing future requirements.
    - (c) Make sure that below threshold reprogramming remains consistent with Army priorities.
- b. Commanders of ACOMs serving as commanders of ASCCs. ACOM commanders serving as commanders of ASCCs identify and integrate with their other missions and operational requirements the requirements of the CCMD.
- c. Commander, Space and Missile Defense Command (SMDC). Serves as proponent of Army FYDP subprogram 3-Space.

## 8-23. Staff Managers and Sponsors for Congressional Appropriations

The Military Deputy for Budget and Execution, the DARNG, CAR, and designated functional managers manage and control Army resources. One set of functional managers addresses manpower and force structure issues. Another set of functional managers assists appropriation sponsors. Tables 8-3 through 8-9 list assignments of appropriation sponsors and functional managers.

**Table 8-3. Budget Activity Management Structure for Operation and Maintenance Appropriations**

Code	Description	Manager <sup>1</sup>
BA 1: Operating forces		
11	Land forces	G-3/5/7 Collective Training Division (DAMO-TRC)
111	Division	
112	Corps Combat Forces	
113	Corps Support Forces	
114	Echelon Above Corps (EAC)-Support Forces	
115	Land Forces Operations Support	
12	Land Forces Readiness	
121	Force Readiness Operations Support	G-3/5/7 Collective Training Division (DAMO-TRC)
122	Land Forces System Readiness	G-3/5/7 Training Simulations Division (DAMO-TRS)
123	Land forces depot maintenance	G-4 Directorate of Sustainment (DALO-SM)
13	Land Forces Readiness Support	
131	Base Operations Support	ACSIM Resources Division (DAIM-ZR)

# HOW THE ARMY RUNS

Code	Description	Manager <sup>1</sup>
132	Sustainment, Restoration, and Modernization (Land Forces Readiness Support)	ACSIM Resources Division (DAIM-ZR)
133	Management and Operational Headquarters	G-1 Manpower Policy, Plans, and Program Division (DAPE-PRA)
134	Unified Commands	G-3/5/7 Resources and Programming Division (DAMO-TRP)
135	Additional Activities	
<b>BA 2: Mobilization</b>		
21	Mobility Operations	G-3/5/7 Collective Training Division (DAMO-TRC)
211	Strategic Mobility	G-3/5/7 Collective Training Division (DAMO-TRC) <sup>2</sup> G-4 Directorate for Force Projection/Distribution (DALO-FP) <sup>3</sup>
212	War Reserve	G-3/5/7 Collective Training Division (DAMO-TRC) <sup>2</sup> G-4 Directorate for Force Projection/Distribution (DALO-FP) <sup>3</sup>
213	Industrial Preparedness	G-4 Directorate for Force Projection/Distribution (DALO-FP) <sup>3</sup>
214	Prepositioned Materiel Configured to Unit Sets (POMCUS)	G-3/5/7 Collective Training Division (DAMO-TRC) <sup>2</sup> G-4 Directorate for Force Projection/Distribution (DALO-FP) <sup>3</sup>
<b>BA3: Training and Recruiting</b>		
31	Accession Training	
311	Officer Acquisition	G-3/5/7 Institutional Training Division (DAMO-TRI)
312	Recruit Training	G-3/5/7 Institutional Training Division (DAMO-TRI)
313	One Station Unit Training	G-3/5/7 Institutional Training Division (DAMO-TRI)
314	Senior Reserve Officers' Training Corps	G-3/6/7 Institutional Training Division (DAMO-TRI)
315	Service Academy Base Support	ACSIM Resource Division (DAIM-ZR)
316	Sustainment Restoration, and Modernization	ACSIM Resource Division (DAIM-ZR)
32	Basic Skill and Advance Training	G-3/5/7 Institutional Training Division (DAMO-TRI)
321	Specialized Skill Training	
322	Flight Training	G-3/5/7 Institutional Training Division (DAMO-TRI)
323	Professional Development Education	G-3/5/7 Institutional Training Division (DAMO-TRI)
324	Training Support	G-3/5/7 Institutional Training Division (DAMO-TRI)
325	Base Support	ACSIM Resource Division (DAIM-ZR)
326	Sustainment, Restoration, and Modernization	ACSIM Resource Division (DAIM-ZR)
33	Recruiting, and Other Training and Education	G-1 Resource Division (DAPE-PRR)
331	Recruiting and Advertising	
332	Examining	
333	Off Duty and Voluntary Education	



## ARMY PLANNING, PROGRAMMING, BUDGETING, AND EXECUTION PROCESS

Code	Description	Manager <sup>1</sup>
334	Civilian Education and Training	G-1 Resource Division (DAPE-PRR)
335	Junior Reserve Officer Training Corps	G-1 Resource Division (DAPE-PRR)
336	Base Support-Recruiting and Examining	ACSIM Resource Division (DAIM-ZR)
<b>BA 4: Administration and Service Wide Activities</b>		
41	Security Programs	G-2 Directorate for Resource Integration (DAMI-RI)
411	Security Programs	
42	Logistics Operations	G-4 Directorate for Sustainment (DALO-SM) G-4 Directorate for Force Projection/Distribution (DALO-FP)
421	Service Wide Transportation	
422	Central Supply Activities	
423	Logistics Support Activities	
424	Ammunition Management	
43	Service Wide Support	
431	Administration	R/P-G-1 Manpower Policy, Plans, and Programs Division (DAPE-PRA)
432	Service Wide Communications	P-CIO/G-6 Program Execution Div (SAIS-ZR)
433	Manpower Management	G-1 Resource Division (DAPE-PRR)
434	Other Personnel Support	G-1 Resource Division (DAPE-PRR)
435	Other Service Support	Various
436	Army Claims and Administrative Support Activities	TJAG
437	Real Estate Management	ACSIM Resource Division (DAIM-ZR)
438	Base Support	ACSIM Resource Division (DAIM-ZR)
439	Defense Environmental Restoration Account (DERA) (FY 18-19)	None
44	Support of Other Nations	G-3/5/7 international Plans, Policy, Programs, and integration Division (DAMO-SSI)
441	International Military Headquarters	
442	Miscellaneous Support of Other Nations	
45	Closed Account	None
49	Defense Environmental Restoration Account (DERA) (FY96)	None

### Legend

Army Manpower and TOA

n BA

nn Activity Group (01 level)

nnn Budget Sub Activity

Records resources for Army Management Structure Code (AMSCO) nnn<sup>\*\*\*</sup>, where nnn shows budget sub activity (see Chaps. AO-2020a-d, h, and j, DFAS-IN Manual 37-100-<sup>\*\*\*</sup> for further information)

### Note:

5. Manager for functional requirements and program and performance except as noted.
6. Manager for functional requirements

**Table 8-4. Budget Activity Management Structure for Operation and Maintenance Appropriations-Army Manpower-Only Activity Structure**

Code	Description	Manager <sup>1</sup>
Category 8: Medical activities, manpower only-reimbursable labor		
84	Medical manpower-reimbursable	TSG Manpower and Programming Division (DASG-PAE-M) <sup>2</sup>
841	Examining activities	
846	Training medical spaces	
847	Care in Army medical centers	
849	Defense medical spaces	
Category 9: Other-manpower only		
91	Special operations forces manpower-reimbursable	G-1 Manpower Policy, and Program Division (DAPE-PRA) <sup>3</sup>
92	Defense agency manpower (military only)	
93	Outside DOD	
94	Transients, holdees, and operating strength deviation	

Legend

Manpower-only activity structure

The PPBE database generates categories 8 and 9 to meet manpower-reporting requirements. Category 8 records resources for AMSOC 84n\*\*\* where n=1, 6, or 7 shows the budget sub activity, category 9 records resources for AMSCO 9n\*\*\*\*, where n=1, 2, 3, or 4 shows the 0-1 level structure.

Note:

7. Manager for functional requirement and program except as noted.
8. Manager for functional requirements.
9. Manager for program and performance.

**Table 8-5. Budget Activity Management Structure for Operation and Maintenance Appropriation-Base Operations Support**

Code	Account	Manager <sup>1</sup>
—	****19, ****20 Child develop services, family centers	ACSIM Resource Division (DAIM-ZR)
AMSCO	****53, ****54, ****56 Environmental conservation, pollution prevention, environmental compliance	ACSIM Resource Division (DAIM-ZR)
AMSCO	****75 Ant-terrorism/Force protection	ACSIM Resource Division (DAIM-ZR)
AMSCO	****79 (Real Property Services)	
.J0	Operation of utilities	ACSIM Resource Division (DAIM-ZR)
*.M0	Municipal Services	ACSIM Resource Division (DAIM-ZR)
.N0	Facilities engineering services	ACSIM Resource Division (DAIM-ZR)
.P0	Fire and emergency response services	ACSIM Resource Division (DAIM-ZR)

## ARMY PLANNING, PROGRAMMING, BUDGETING, AND EXECUTION PROCESS

Code	Account	Manager <sup>1</sup>
AMSCO	****90 Audio visual and visual information production, acquisition, and support	P-CIO/G-6 Program Execution Div (SAIS-ZR) <sup>2</sup> ACSIM Resource Division (DAIM-ZR) <sup>3</sup>
AMSCO	****95 Base communications	P-CIO/G-6 Program Execution Div (SAIS-ZR) <sup>2</sup> ACSIM Resource Division (DAIM-ZR) <sup>3</sup>
AMSCO	****96 (Base Operations Support) (BASOPS(-))	
.A0	Real estate leases	ACSIM Resource Division (DAIM-ZR)
.B0	Supply operations and management	G-4 Directorate for Sustainment (DALO-SM)
.C0	Materiel maintenance	G-4 Directorate for Sustainment (DALO-SM)
.D0	Transportation services	G-4 Directorate for Sustainment (DALO-SM)
.E0	Laundry and dry-cleaning services	G-4 Directorate for Sustainment (DALO-SM)
.F0	The Army food service program	G-4 Directorate for Sustainment (DALO-SM)
.K0	Civilian personnel management	R/P-G-1
.L0	Morale, welfare, and recreation	ACSIM Resource Division (DAIM-ZR)
.M0	Military personnel support	R/P-G-1
.Q0	Reserve component support	ACSIM Resource Division (DAIM-ZR)
.U0	Financial management	ASA (FM&C)
.V0	Management analysis	ASA(FM&C)
.W0	Contracting operations	ASA(ALT) Plans, Programs and Resources Directorate (SAAL-RI)
.X0	IT, management and planning	P-CIO/G-6 Program Execution Div (SAIS-ZR) <sup>2</sup> ACSIM Resource Division (DAIM-ZR) <sup>3</sup>
.Y0	Administrative services	P-CIO/G-6 Program Execution Div (SAIS-ZR) <sup>2</sup> ACSIM Resource Division (DAIM-ZR) <sup>3</sup>
.10	Provost Marshal	G-3 Security, Force Protection, and Law Enforcement (DAMO-ODL)
.20	Staff Judge Advocate	ACSIM Resource Division (DAIM-ZR)
.30	Chaplain	ACSIM Resource Division (DAIM-ZR)
.40	Public affairs	ACSIM Resource Division (DAIM-ZR)
.50	Inspector General	ACSIM Resource Division (DAIM-ZR)
.60	Installation management	ACSIM Resource Division (DAIM-ZR)

## HOW THE ARMY RUNS

Code	Account	Manager <sup>1</sup>
.70	Operations	ACSIM Resource Division (DAIM-ZR)
.90	Unaccompanied personnel housing management	ACSIM Resource Division (DAIM-ZR)

### Legend

#### Base Support

Base Operations Support (BOS) applies to sub activity groups 131, 315, 325, 336, and 438

Base support refers to the resources to operate and maintain Army installations (major, minor, stations, other). It comprises two sub activity groups: Base Operations Support (BOS) and Sustainment, Restoration, and Modernization (SRM). Resources are recorded in Army Management Structure Code (AMSCO) and nnn\* yy, where nnn shows budget sub activity group (SAG) and yy designates specified subdivisions. Sometimes, resources are recorded as nnn\*yy.z0, where .z0 refers to letter accounts, as below for BASOPS (-) and SRM. (See chap A9-BSSPT, DFAS-IN Manual 37-100-\*\*\*\* for further information.)

#### Note:

10. Manager for functional requirements and program and performance.
11. Manager for functional requirements.
12. Manager for program and performance.

**Table 8-6. Budget Activity Management Structure for Operation and Maintenance Appropriations-Sustainment, Restoration, and Modernization**

Code	Account	Manager <sup>1</sup>
AMSC O	****76	
.L0	Minor construction	ACSIM Resource Division (DAIM-ZR)
AMSC O	****78 (Maintenance and Repair)	
.10	Surfaced areas (including bridges and other appurtenances)	ACSIM Resource Division (DAIM-ZR)
.20	Airfields, paved and unpaved (including bridges and other appurtenances)	ACSIM Resource Division (DAIM-ZR)
.40	Railroads (including bridges and other appurtenances)	ACSIM Resource Division (DAIM-ZR)
.50	Utility systems	ACSIM Resource Division (DAIM-ZR)
.A0	Maintenance and production facilities	ACSIM Resource Division (DAIM-ZR)
.B0	Training and operations facilities	ACSIM Resource Division (DAIM-ZR)
.C0	RDT&E facilities	ACSIM Resource Division (DAIM-ZR)
.D0	Supply and storage facilities	ACSIM Resource Division (DAIM-ZR)
.E0	Administrative facilities (including IT facilities)	ACSIM Resource Division (DAIM-ZR)
.F0	Unaccompanied personnel housing facilities	ACSIM Resource Division (DAIM-ZR)
.G0	Other unaccompanied personnel housing facilities	ACSIM Resource Division (DAIM-ZR)
.H0	Dining facilities	ACSIM Resource Division (DAIM-ZR)

## ARMY PLANNING, PROGRAMMING, BUDGETING, AND EXECUTION PROCESS

Code	Account	Manager <sup>1</sup>
.Q0	Other facilities without facility category groups (FCG)	ACSIM Resource Division (DAIM-ZR)
.R0	Airfield facilities	ACSIM Resource Division (DAIM-ZR)
.S0	Training/instruction support facilities	ACSIM Resource Division (DAIM-ZR)
.T0	Ports	ACSIM Resource Division (DAIM-ZR)
.U0	Medical and hospital facilities	ACSIM Resource Division (DAIM-ZR)
.V0	Grounds	ACSIM Resource Division (DAIM-ZR)
.W0	Community support	ACSIM Resource Division (DAIM-ZR)
.X0	Family housing	ACSIM Resource Division (DAIM-ZR)
AMSC O	****93 Demolition of real property	ACSIM Resource Division (DAIM-ZR)

Note:

13. Manager for functional requirements and program and performance

**Table 8-7. Budget Activity Management Structure for Operation and Maintenance Appropriations-Army National Guard**

Code	Description	Manager <sup>1</sup>
	BA 1: Operating forces	DARNG <sup>1</sup>
11	Land Forces	
111	Division	
112	Corps combat forces	
113	Corps support forces	
114	Echelon above corps (EAC)-forces	
115	Land forces operations support	
12	Land forces readiness	
122	Land forces system readiness	
123	Land forces depot maintenance	
13	Land forces readiness support	
131	Base operations support (land forces readiness support)	
132	Sustainment, restoration, and Modernization	
133	Management and operational headquarters	
135	Weapons of mass destruction	
	BA 4: Administration and service wide activities	DARNG <sup>1</sup>
43	Service wide support	
431	Staff management	
432	Information management	
433	Readiness and personnel administration	
434	Recruiting and advertising	

## HOW THE ARMY RUNS

---

### Legend

Army National Guard

n BA

nn Activity Group (01 level)

nnn Budget Sub Activity

---

### Note:

14. Budget Formulation Branch (NGB-ARC-BF): Manager for functional requirements and program and performance.

15. Budget Branch (DAAR-CFM): Manager for functional requirements and program and performance

---



---

**Table 8-8. Budget Activity Management Structure for Operations and Maintenance Appropriations-United States Army Reserve**

Code	Description	Manager <sup>1</sup>
	BA 1: Operating forces	CAR <sup>2</sup>
11	Land forces	
111	Divisions	
112	Corps combat forces	
113	Corps support forces	
114	Echelon above corps (EAC)-forces	
115	Land forces operations support	
12	Land forces readiness	
121	Force readiness operations support	
122	Land forces system readiness	
123	Depot maintenance	
13	Land forces readiness support	
131	Base operations support	
132	Sustainment, Restoration, and Modernization	
135	Additional activities	
	BA 4: Administration and service wide activities	CAR <sup>2</sup>
43	Service wide support	
431	Administration	
432	Service wide communications	
433	Personnel/financial administration	
434	Recruiting and advertising	

---

### Legend

U.S. Army Reserve

n BA

nn Activity Group (01 level)

nnn Sub Activity Group

---

### Note:

16. Budget Formulation Branch (NGB-ARC-BF): Managers for functional requirements and program and performance.

17. Budget Branch (DAAR-CFM): Manager for functional requirements and program and performance.

---

# ARMY PLANNING, PROGRAMMING, BUDGETING, AND EXECUTION PROCESS

**Table 8-9. Army Appropriations-Managers for Functional Requirements and Program and Performance**

Resource Identification Code	Appropriation (Fund) <sup>1</sup>	Manager for Functional Requirements (R) Manager for Program and Performance (P)
RDT&E	Investment Research, Development, Test, and Evaluation, Army	R-G-8 Programs and Priorities (DAPR-FDR) P-ASA(ALT) Plans, Programs and Resources Directorate (SAAL-RI)
ACFT (APA)	Aircraft Procurement, Army	R- G-8 Programs and Priorities (DAPR-FDR) P-ASA(ALT) Plans, Programs and Resources Directorate (SAAL-RI)
MSLS (MIPA)	Missile Procurement, Army	R- G-8 Programs and Priorities (DAPR-FDR) P-ASA(ALT) Plans, Programs and Resources Directorate (SAAL-RI)
WTCV	Procurement of Weapons and Tracked Combat Vehicles, Army	R- G-8 Programs and Priorities (DAPR-FDR) P-ASA(ALT) Plans, Programs and Resources Directorate (SAAL-RI)
AMMO (PAA)	Procurement of Ammunition, Army	R- G-8 Programs and Priorities (DAPR-FDR) R-G-4 Directorate for Sustainment (DALO-SM) P-ASA(ALT) Plans, Programs and Resources Directorate (SAAL-RI)
OPA	Other Procurement, Army	R- G-8 Programs and Priorities (DAPR-FDR) P-ASA(ALT) Plans, Programs and Resources Directorate (SAAL-RI)
	OPA 1	R- G-8 Programs and Priorities (DAPR-FDR) P-ASA(ALT) Plans, Programs and Resources Directorate (SAAL-RI)
	OPA 2	R- G-8 Programs and Priorities (DAPR-FDR) P-ASA(ALT) Plans, Programs and Resources Directorate (SAAL-RI)
	OPA 3	P-CIO/G-6 Program Execution Div (SAIS-ZR) R- G-8 Programs and Priorities (DAPR-FDR) P-ASA(ALT) Plans, Programs and Resources Directorate (SAAL-RI)
	OPA 4	R- G-8 Programs and Priorities (DAPR-FDR) P-ASA(ALT) Plans, Programs and Resources Directorate (SAAL-RI)
MCA	Military Construction, Army <sup>2</sup>	R-ACSIM Facilities Division (DAIM-FD) P-ACSIM Resources Division (DAIM-ZR)
MCNG	Military Construction, Army National Guard <sup>2</sup>	R-DARNG Engineering Directorate (NGB-AEN) P-ACSIM ACSIM Resources Division (DAIM- ZR)
MCAR	Military Construction, Army Reserve <sup>2</sup>	R-CAR Army Reserve Engineer Directorate (DAAR-EN) P- ACSIM Resources Division (DAIM-ZR)
CHEM	Chemical Agents and Munitions Destruction, Army	R- G-8 Programs and Priorities (DAPR-FDR) P-ASA(ALT) Plans, Programs and Resources Directorate (SAAL-RI)
AFHC	Family Housing, Army (Construction) Operations	R/P- ACSIM Facilities Division (DAIM-FD)

## HOW THE ARMY RUNS

Resource Identification Code	Appropriation (Fund) <sup>1</sup>	Manager for Functional Requirements (R) Manager for Program and Performance (P)
ERA	Environmental Restoration, Army and Formerly Used Test Sites	R/P-ACSIM Environmental Division (DAIM-ED)
BRAC	Base Realignment and Closure	R/P-ACSIM BRAC Office (DAIM-BO)
AFHO	Family Housing, Army (Operations)	R/P- ACSIM Facilities Division (DAIM-FD)
OMA	Operation and Maintenance, Army	See Tables 8-8 through 8-11
OMNG	Operation and Maintenance, Army National Guard	See Table 8-12
OMAR	Operation and Maintenance, Army Reserve	See Table 8-13
MPA	Military Personnel, Army	R/P- G-1 Manpower Policy, Plans, and Program Division (DAPE-PRA)
NGPA	National Guard Personnel, Army	R/P-DARNG Budget Formulation Branch (NGB-ARC-BF)
RPA	Reserve Personnel, Army	R/P-CAR Budget Branch (DAAR-CFM)
HAF-D	Homeowners Assistance Fund Defense	R/P-COE

Appropriation sponsors and functional managers' general responsibilities are as follows—

a. Manager for manpower and force structure issues. The managers for manpower and force structure issues work together to maintain a continuous exchange of information and collaboration during each PPBE phase. As appropriate, they—

(1) Coordinate instructions to the field, and the processing of requests from the field, for manpower or force changes.

(2) Align and balance manpower and unit information among such PPBE database systems as the Structure and Manpower Allocation System (SAMAS), the PPBE Enterprise System and the FYDP.

(3) Provide lead support on manpower issues to PEG chairs.

(4) Verify manpower affordability.

b. Manager for functional requirements. The manager for functional requirements—

(1) Determines the scope, quantity, and qualitative nature of functional requirements for planning, programming, and budgeting.

(2) Checks how commands and agencies apply allocated manpower and dollars to make sure their use fulfills program requirements.

(3) Prioritizes unfunded programs submitted by ACOMs, PEOs, and other operating agencies.

(4) Using Army PBG and priorities, resolves conflicts involving unfunded requirements or decrements on which ACOMs, PEOs, and other operating agencies fail to reach agreement in developing the program or budget.

(5) Recommends to the PPBC the allocation of available resources, unfunded programs, and offsetting decrements.

(6) During program and budget reviews, and throughout the process, coordinates resource changes with agencies having responsibility for affected MDEPs and with the appropriate appropriation sponsor for relevant resources.

c. Manager for program and performance. The manager for program and performance—

(1) Represents the functional program and monitors its performance during each PPBE phase.

(2) As required, helps perform the duties of the appropriation sponsor.

(3) Translates budget decisions and approved manpower and funding into program changes and makes sure that data transactions update affected MDEPs and, in coordination with the appropriation sponsors, affected appropriations.



- (4) Checks budget execution from the functional perspective.
- (5) For investment appropriations:
  - (a) Operates and maintains databases in support of the PPBE Enterprise System.
  - (b) During budget formulation, determines how changes in fiscal guidance affect budget estimates and reviews and approves the documentation of budget justification.
  - (c) During review of the budget by OSD and OMB and by Congress, serves as appropriation advocate, helps prepare the Army response to OSD IPs which are the result of IP proposals, and prepares congressional appeals.
  - (d) During execution determines fund recipients, monitors execution, performs decrement reviews, plans reprogramming, and controls below threshold reprogramming. On RDT&E and procurement matters and otherwise as required, testifies before OSD and Congress.
- d. Appropriation Sponsor. The appropriation sponsor—
  - (1) Controls the assigned appropriation or fund.
  - (2) Serves as Army spokesperson for appropriation resources.
  - (3) Helps resource claimants solve manpower and funding deficiencies.
  - (4) Issues budget policy, instructions, and fiscal guidance.
  - (5) During budget formulation:
    - (a) Bears responsibility for updating the PPBE database.
    - (b) Prepares and justify budget estimates, coordinating with functional and manpower representatives to make sure appropriate exhibits and database systems match.
    - (6) Testifies before Congress during budget justification.
    - (7) Manages financial execution of the appropriation and reprograms allocated manpower and funds to meet unforeseen contingencies during budget execution.

## Section VI Allocation of Resources

### 8-24. Recording Resources

- a. The Army MDEP serves as a key resource management tool. Collectively, MDEPs account for all Army resources. They describe the capabilities programmed over a 9-year period for the Active Army, Guard, Reserve, and civilian work force.
- b. Recording the resources needed to gain an intended outcome, an individual MDEP describes a particular organization, program, or function and applies uniquely to one of the following areas for resource management—
  - (1) Missions of Modified Tables of Organization and Equipment (MTOE) units.
  - (2) Missions of Tables of Distribution and Allowances (TDA) units.
  - (3) Acquisition, fielding, and sustainment of weapon and information systems (with linkage to organizations).
  - (4) Special Visibility Programs (SVP).
  - (5) Short-Term Projects (STP).
- c. In short, the MDEP specifies the military and civilian manpower and dollars associated with a program undertaking; displays needed resources across relevant Army commands (ACOM) and relevant appropriations; and justifies the resource expenditure.
- d. HQDA uses the MDEP to help develop programs to support the requirements, carry-out approved programs, and check program results.
- e. HQDA uses the MDEP to link decisions by the SECARMY and CSA and their priorities to:
  - (1) FYDP accounts that record Service positions in OSD.
  - (2) AMSCO accounts that record funding transactions in Army activities and installations.
- f. HQDA uses the MDEP also to link key systems within the PPBE Enterprise System, for example:
  - (1) The Structure and Manpower Allocation System (SAMAS).
  - (2) The Army Training Requirements and Resources System (ATRRS) whose product, the Army Program for Individual Training (ARPRINT), shows valid training requirements and associated training programs.
  - (3) Depot maintenance programs.

g. For investment accounts, managers for construction, RDT&E, and procurement first allocate program and budget resources by AMSCO, APEs, project number, and BLIN. They then distribute the resources to MDEPs within the resource management areas.

**8-25. Program and Budget Years Covered by the MDEP**

a. The MDEP records manpower and TOA over the 9 fiscal years (FY) needed to display the program and budget. Which program year (PY) or which BY each FY addresses, depends on whether interest in the MDEP centers on the program or budget. Figure 8-6 shows the definition and functions of an MDEP. Figure 8-7 shows the FY structure of an MDEP as applied to the FY 17-21 PB, and considers the complementary way that programmers and budgeters view resource requirements. The display shows from left to right the manpower and dollars needed to carry out missions and functions. From top to bottom, the display shows how these requirements are distributed among Army programs to form appropriation requests to Congress.

b. The MDEP shifts forward one year in the annual POM / BES submission. At the start of the cycle for the next annual POM / BES, the PPBE database drops the earliest year from the database and adds one new year. The first of the preceding years is the PY. It records resources spent in executing the budget the year before the CY. The CY shows resources in the budget being executed. The last preceding year is called the BY. It lists resources requested in the PB being reviewed by Congress.

---





## Management Decision Execution Package

**Definition:**

- A stand-alone functional package that describes a particular organization, program, or function capturing total resources over a 9-year period

**Functions:**

- What capability is resourced?
- How much is resourced?
- Why resource this capability?
- Who is responsible?
- When are resources available?

- Battlefield Observation
-  +  +  + 
- Capabilities (Survivability, Intelligence, etc.)
- DCS, G-3/5/7
- Year (Prior, Current, Budget, Program)?

**The MDEP is an Army Programming Tool**

---

Figure 8-6. Management Decision Execution Package

## FY 11-24 POM MDEP

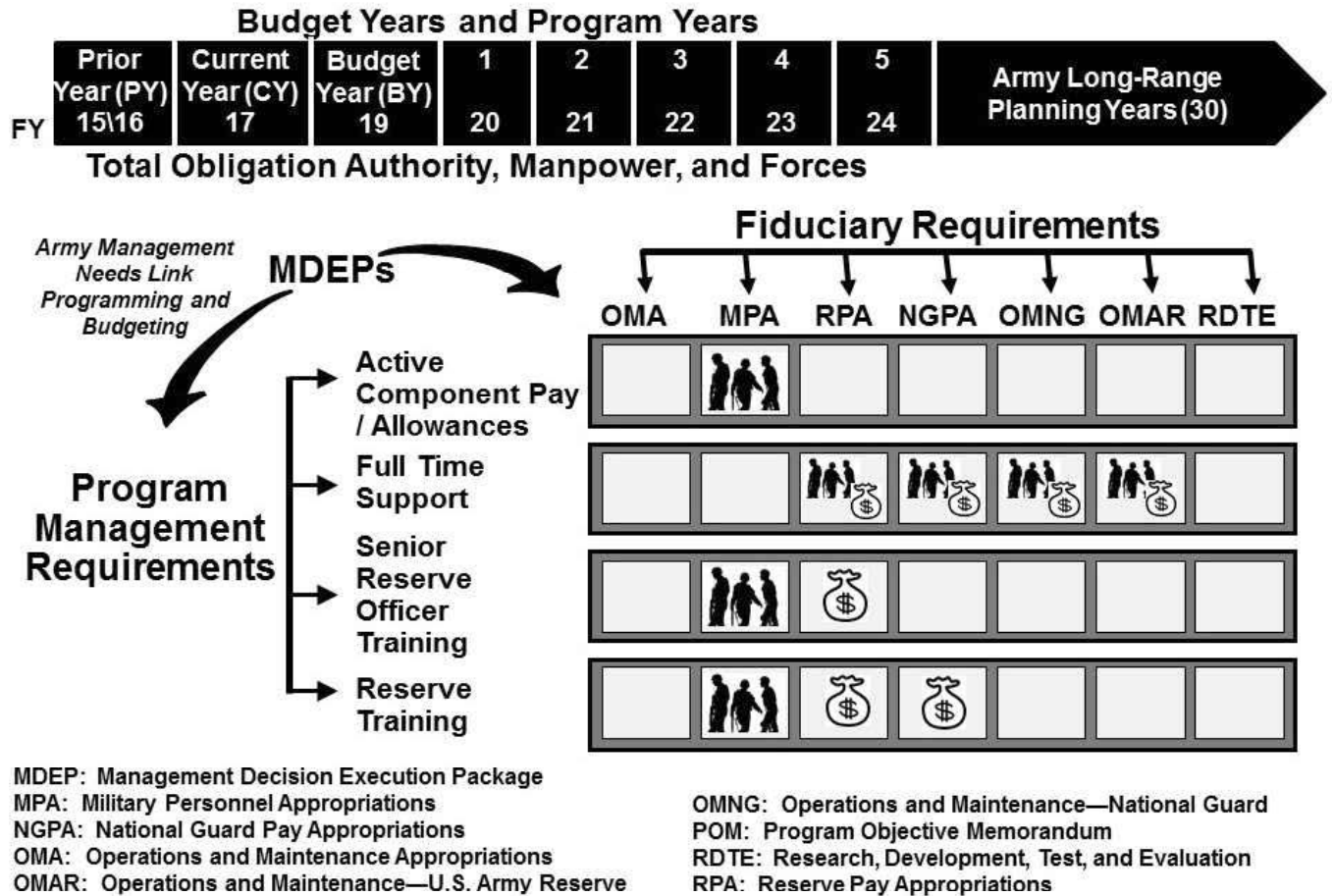

**Figure 8-7. Fiscal Year 17-21 Program Objective Memorandum Management Decision Execution Package**

### 8-26. Extent that Manpower and Dollars can be redistributed in the Management Decision Execution Package

- a. The MDEP, as just described, has both BY and PY increments. The two increments differ primarily by the flexibility the Army has with manpower and funds.
- b. During the program or POM years, HQDA is constrained by Congress on total military end strength and by FG. HQDA determines and approves civilian work year levels by balancing workload and available funding. Similarly, HQDA restricts program dollars only by TOA, not by individual appropriation. The distinctions allow redistributing previously programmed manpower and dollars to meet changing requirements. In later POM or budget submissions, for example, HQDA can, as needed, move PY resources between MDEPs, appropriations, and APEs.
- c. Once HQDA sends the BES to OSD, OSD must approve any changes to manpower and dollars. Even tighter controls govern changes in manpower and funding in the BYs after the PB has gone to Congress.
  - (1) HQDA can redistribute previously budgeted manpower and dollars between MDEPs or commands and agencies, but must leave current budgeted dollars unchanged until CY appropriations become law.
  - (2) Some flexibility during execution permits financing unbudgeted requirements to meet unforeseen needs or changes in operating conditions. Even so, Congressional rules and specified dollar thresholds severely restrict spending for purposes other than those originally justified and approved. In addition,

during execution, HQDA can transfer military and civilian manpower within appropriations without a corresponding transfer of funds.

### 8-27. How Flexibility Affects the Management Decision Execution Package

a. *Frequent Change in MDEP Resources.* Competition at each stage of program development and budget formulation can produce frequent change in an MDEP's resource levels. Decisions resulting from OSD review of the POM/BES will further change amounts initially approved. Sometimes decisions may even affect requests in the PB already before Congress. Authorization and appropriation decisions by Congress often change amounts requested in the PB. Budget execution sometimes results in different rates and quantities of expenditure from those planned, and, at times, it results in different purposes.

b. *Keeping MDEP Resources Current.* Program and budget analysts continually update MDEPs through their respective feeder systems to reflect the position of the last program or budget event. The kinds of changes described require that resource managers continually weigh how the stream of program and budget actions affect the MDEP and how a change in the PY or BY portion of the package may affect the out years. Managers continually ask, "In what ways do the changes: alter MDEP resource levels; shift resources between years; and affect resources in related MDEPs?"

c. *Army Management Structure (AMS).* The AMS serves as a second major resource recording structure. Based on congressional appropriations, the AMS relates program dollars and manpower to a standard classification of activities and functions per DFAS-IN Manual 37-100-\*\*\*\* (where \*\*\*\* stands for the CY, e.g., 2016). AMSCO help record the data in the detail needed for budgeting, execution, and accounting.

### 8-28. Other Structures

Other fiscal management structures include the 01 level BA structure for operation and maintenance appropriations shown in Tables 8-8 through 8-14, SSN and BLIN for weapon systems, and project numbers for military construction automated support. The automated Army PPBE System supports Army PPBE functions and DOD PPBE data submissions to OSD, OMB, and Congress. Known simply as the PPBE database, it encompasses forces, funds, and manpower and serves as the database of record for Army resources.

a. *PPBE Database.* The PPBE database organizes and registers 9 years of dollar and manpower data used in the process, and 12 years of forces data. It gathers manpower and dollar data through keys tied to the MDEP, appropriation, PEs, APEs, and other identifiers including the command or resource organization code. HQDA uses the database to—

- (1) Support user analysis.
- (2) Build and record the combined POM / BES.
- (3) Prepare the Army portion of the FYDP to reflect the POM / BES and later the PB.
- (4) Report consistent Army resource positions to OSD through the Select and Native Programming (SNaP) Data Collection System, SDCS, SSMS, and CIS.
- (5) Issue ACOMs PBG reflecting the FYDP resource position after each FYDP update.
- (6) Provide MDEP execution and expenditure information.

b. *Future System Enhancement.* The Planning, Programming and Budgeting (PPB) Business Operating System (BOS) standardizes and better integrate the transactional automated information systems used in the HQDA level programming and budgeting processes. These systems are core to the PPBE business processes of the headquarters for gathering programmatic requirements, balancing resources and delivering the Army's program budget to OSD. The BOS streamlines programming and budgeting business processes and significantly improves strategic analysis capabilities. The BOS provides architecting, reengineering, and consolidating of HQDA systems, feeder database systems, and the business processes associated with them. BOS has improved capabilities, eliminated redundancies and reduced overall costs of operations.

## Section VII

### Army Planning, Programming, Budgeting, and Execution Deliberative Forums

#### 8-29. Army Decision Committees and Processes

a. Program Budget Assessment Team (PBAT) is a working-level forum that meets throughout the PPBE process. The PBAT will assist the PPBC Council of Colonels and the PEGs by disposing of low-level resource issues, within its authority. The PBAT will—

(1) Review resource change requests (accepted during the PEG process), Concept Plans, and other changes to resources within its authority, with a particular focus on manpower issues.

(2) Prepare and coordinate resource recommendations on those issues selected for presentation to the PPBC Council of Colonels for action.

(3) Monitor the activities of the other PPBE decision forums.

(4) The PBAT will have four co-chairs from the following organizations:

(a) Chief Budget Formulation Division, Management and Control Directorate, ASA (FM&C)

(b) Chief Resource Development Branch, Resource Division, DCS G-1 Programs and Resources

(c) Chief Program Budget Guidance Branch, Force Accounting and Document Division, DCS G3/5/7 FM

(d) Deputy Division Chief, Program Development Division, PA&E

b. The PPBC Council of Colonels is co-chaired by the Chief, Resource Analysis and Integration Division, G-3/5/7; Chief Program Development Division, PAED; and the Chief, PPBE Integration, ASA(FM&C). The PPBE Council of Colonels is a continuing forum that meets throughout the PPBE process. This forum represents the PPBC and serves as the normal entry point for all resourcing issues presented to them for decision, either at their level or at a higher level. The PPBC Council of Colonels will —

(1) Act as a gatekeeper for other issues with resourcing implications.

(2) Package proposals, frames issues and recommendations, and coordinates all issues with resourcing implications to be presented to higher-level decision forums.

(3) Oversee implementation of senior level PPBE decisions and guidance within HQDA and may issue additional guidance to ensure prompt and proper implementation.

(4) Monitor the activities of the other PPBE decision forums.

(5) Membership of the PPBC Council of Colonels includes COL/GS15 Secretariat and Army Staff representatives from the PEGs and PEG integrators. Other Secretariat and Army Staff representatives attend as required to ensure synchronization and transparency of the PPBE process.

(6) The co-chairs of the PPBC Council of Colonels also co-chair Colonel Budget Requirements and Program forum.

c. Planning, Program, Budget Committee (PPBC) has three co-chairs, one of whom presides over the forum depending upon the subject matter under consideration - the ADCS G-3/5/7 for planning, the DPAE for programming, and the DAB for budgeting and execution. The PPBC serves the PPBE process in both a coordinating and executive-advisory role. It provides a continuing forum in which planning, program, and budget managers review, adjust, and recommend courses of action on relevant issues. The PPBC may return the results of committee deliberations to the Army Staff or Secretariat for action. It may pass them, in turn, to the SRG for review or approval. Among its responsibilities, the PPBC:

(1) Maintains overall discipline of the PPBE process.

(2) Oversees the PPBE schedule, with each chair controlling the chair's respective portion of the schedule.

(3) Monitors force management and preparation of TAP, POM/BES, and PB.

(4) Makes sure that Army policy remains internally consistent and that program adjustments remain consistent with Army policy and priorities.

(5) Maintains the PPBE Strategic Automation Committee to implement configuration management of the PPBE Enterprise process and to oversee long-term plans for investing in IT to improve the performance of PPBE functions.

(6) As required, set up other standing committees or working groups to resolve issues that arise in managing the program or budget.

(7) Membership of the PPBC includes Secretariat and Army Staff representatives from the PEGs and PEG integrators. Other Secretariat and Army Staff representatives attend as required to ensure synchronization and transparency of the PPBE process.

- (8) The co-chairs of the PPBC also co-chair 2-Star Budget Requirements and Program forum.
- d. Colonel Budget, Requirements, and Programs (BRP) are gatekeepers for issues with year of execution resourcing implications and packages proposals, frames issues, and coordinates matters that go before the 2-Star and 3-Star BRP.
- e. 2-Star BRP serve in an executive-advisory role enforcing discipline of resourcing process and ensuring resourcing decisions align with Army priorities. The 2-Star BRP recommends POM / BES solutions to the 3-Star BRP.
- f. 3-Star BRP resolves resource allocation issues, synchronizes decisions with POM / BES, and serve as the key 3-Star level forum for working time-sensitive issues. The 3-Star BRP is co-chaired by the Military Deputy to the ASA (FMC), the ADCS G3/5/7 and the G-8. 3-Star BRP membership includes 3 Star GO/SES level representatives from the Secretariat and ARSTAF.
- g. Army Management Action Group (AMAG) was established by the Secretary of the Army in June 2014 to provide an Army level discussion and decision forum similar to the Defense Management Action Group (DMAG).
- (1) The Under Secretary of the Army and the VCSA are the AMAG co-chairs. The Deputy Under Secretary of the Army and the Director of the Army Staff are permanent members of the AMAG. The co-chairs determine other regular or ad hoc attendees as required. The AMAG:
- (a) Addresses questions of enterprise-level strategy, policy, or management that have cross cutting implications throughout the Army.
- (b) Serves as the primary deliberative body for all documents, decisions, and components of the Army Plan
- h. Senior Review Group (SRG) serves as the senior Army leadership decision making forum and is chaired by the SECARMY and the CSA with representation from all the Secretariat and ARSTAF organizations and the ACOMS. The SRG:
- (1) Sets policy and approves guidance and priorities.
- (2) Reviews and approves the Army POM/BES
- (3) Approves prioritization of Army programs. See Figure 8-8 for Army Decision Committees and Processes

### PPBE Decision Committees / Processes

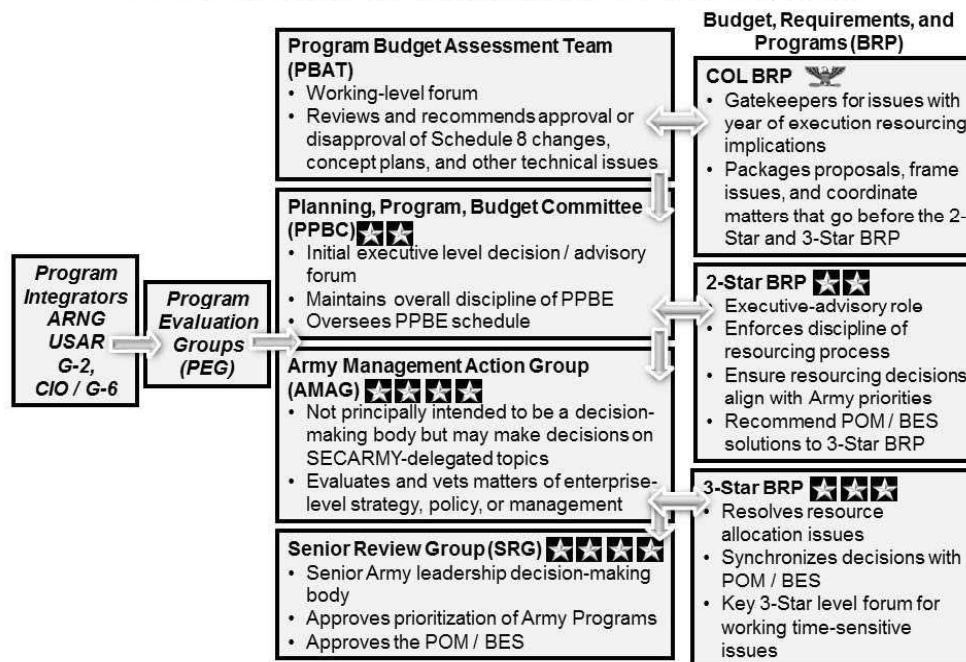

Figure 8-8. Planning, Programming, Budgeting, and Execution Decision Committees and Processes

**8-30. The Program Evaluation Groups**

a. Program Integrators. The ARNG, USAR, G-2, and CIO / G-6 serve as program integrators to the PEGs. Program integrators provide technical assistance and monitor actions to integrate priorities and statutory, defense, and Army requirements for the ARNG, AR and IT programs into the Army's overall program.

b. PEGs. HQDA uses six PEGs to support PPBE (see Figs 8-9 and 8-10). Each PEG is co-chaired by a representative of the Secretariat and a representative of the PEG's proponent, who provide the PEG with executive and administrative support. Permanent members include representatives of ASA (FM&C) appropriation sponsors, G-3/5/7 program prioritizers and requirements staff officers (RSO), and G-8 PAE program integrators.

(1) PEGs program and monitor resources to perform Army functions assigned by 10 USC, Subtitle B, Army, and to support the CCMDs and OSD-assigned executive agencies. Each PEG administers a set of MDEPs within one of the following functional groupings: Manning (MM), Training (TT), Organizing (OO), Equipping (EE), Sustaining (SS), and Installations (II).

(2) Each PEG, subject to existing PBG, sets the scope, quantity, priority, and qualitative nature of resource requirements that define its program. They monitor PEG resource transactions and, as required, make both administrative and substantive changes to assigned MDEPs. MDEP proponents, subject matter experts, and, as appropriate, representatives of commands and agencies participate in PEG deliberations.

(3) PEGs, assisted by program integrators, help HQDA functional proponents—

- (a) Build TAP and the Army program and help convert the program into budget-level detail.
- (b) Maintain program consistency, first during planning and later when preparing, analyzing, and defending the integrated program-budget.
- (c) Track program and budget performance during execution.
- (d) Keep abreast of policy changes during each phase of the PPBE process.

**Program Evaluation Groups**

PEG Name	Proponent	Co-Chair for Policy Determination	Co-Chair for Requirements Determination	Appropriation Sponsor*	Program Integrator
Organizing	AASA	ASA (M&RA)	AASA		
Manning	DCS G-1	ASA (M&RA)	DCS G-1	ASA (FM&C)	G8 PA&E, G-3/5/7
Training	DCS G-3/5/7	ASA (M&RA)	DCS G-3/5/7		
Equipping	DCS G-8	ASA (ALT)	DCS G-8		
Sustaining	DCS G-4	ASA (ALT)	DCS G-4		
Installations	ACSIM	ASA (IE&E)	ACSIM		

AASA: Administrative Assistant to the Secretary of the Army  
 ACSIM: Assistant Chief of Staff for Installation Management  
 ASA(ALT): Assistant Secretary of the Army (Acquisition, Technology, & Logistics)  
 ASA (IE&E): Assistant Secretary of the Army (Installations, Energy, & Environment)  
 ASA(M&RA): Assistant Secretary of the Army (Manpower & Reserve Affairs)  
 PA&E: Program, Analysis, & Evaluation

\* Includes CNGB & CAR

**Figure 8-9. Program Evaluation Groups**

# PEG Functions

<p><b>Organizing (OO)</b></p> <ul style="list-style-type: none"> <li>• Provides minimum essential generating forces for peacetime sustainment and training, and wartime mobilization and power projection capabilities for operating forces</li> <li>• Supports special programs that meet the needs of the Army</li> </ul>	<p><b>Equipping (EE)</b></p> <ul style="list-style-type: none"> <li>• Provides resources for the integration of new doctrine, training, organization, and equipment for developing and fielding warfighting capabilities for the Active Army, ARNG and USAR</li> <li>• Focuses mainly on materiel acquisition which comprises Research, Development, Test &amp; Evaluation (RDT&amp;E) and procurement of weapons and equipment</li> <li>• Considers operating and support costs to field weapons and equipment, as well as the cost of combat development</li> </ul>
<p><b>Manning (MM)</b></p> <ul style="list-style-type: none"> <li>• Provides the Active Army, Army National Guard (ARNG) and U.S. Army Reserve (USAR) with authorized personnel by grade and skill</li> <li>• Integrates the personnel authorizations for the ARNG and USAR</li> </ul>	<p><b>Sustaining (SS)</b></p> <ul style="list-style-type: none"> <li>• Provides resources to sustain operations of the Active Army, ARNG and USAR, stressing worldwide readiness.</li> <li>• Scope embraces strategic mobility, reserve stocks, industrial preparedness, central supply, and internal operations of depots' materiel maintenance</li> <li>• Includes measures to assure the quality and timeliness of strategic logistics systems, manage weapons systems, provide security assistance, conduct logistical long-range planning, and reshape logistics</li> <li>• Addresses measures to streamline business operations, improve information management structure, further the integration, sharing, standardization, and interoperability of information systems</li> </ul>
<p><b>Training (TT)</b></p> <ul style="list-style-type: none"> <li>• Provides resources for Active Army, ARNG and USAR unit readiness (to include medical units) and unit collective training (ground OPTEMPO and the flying hour program, fixed wing aircraft operation and maintenance, combat training centers (CTC), mobilization, theater security cooperation (TSC) activities and military contingency operations</li> <li>• Provides for collective training, institutional training (initial entry training, leader development, professional development, functional training), and officer acquisition (United States Military Academy (USMA), Reserve Officer Training Corps (ROTC), Officer Candidate School (OCS))</li> <li>• Supports multi-national force compatibility through integrated training, military exercises, and command control exchanges with allies and coalition partners</li> <li>• Deals with programs, systems, and activities to satisfy intelligence requirements of the President of the United States (POTUS) and Secretary of Defense (SECDEF) as well as those of the senior leadership; these are requirements funded in the Army portion of the National Foreign Intelligence Program (NFIP) under Program 31 and intelligence support to national agencies under Program 9 (Equipping PEG manages most requirements for tactical intelligence and related activities (TIARA) managed by G-8 FD under Program 2, and 4 through 10, as well as acquisitions to meet other intelligence and electronic warfare (IEW) requirements</li> </ul>	<p><b>Installations (II)</b></p> <ul style="list-style-type: none"> <li>• Provides resources to support Active Army, ARNG and USAR installations—the operational and service support centers where Soldiers, families and civilians work, live, and train</li> <li>• Plans and programs installation funding for base support, military construction, family housing, base realignment and closure, and environment restoration programs</li> <li>• Base support is provided in two parts:             <ul style="list-style-type: none"> <li>✓ Base operations support (BOS) consisting of base operations (BASOPS), anti-terrorism, force protection, family programs, environment, and audio visual base communications</li> <li>✓ Sustainment, restoration and modernization providing for maintenance, demolition, improvement or replacement of facilities and infrastructure</li> </ul> </li> <li>• Provides for minimal essential workforce in support of installation management and continuously seeks to leverage current strength by converting non-core military to civilian employees for contract, where appropriate</li> </ul>

Figure 8-10. Program Evaluation Group Functions



## Section VIII

### Army Planning, Programming, Budgeting, and Execution—Planning

#### 8-31. The Army Plan

See Chapter 2, Strategy.

#### 8-32. Required Capability Determination

a. See Chapter 10, Capability Requirements and Materiel System Research, Development, and Acquisition Management, for details on the Joint Capabilities Integration and Development System (JCIDS).

b. Beginning in October and November, in the early stages of program development, requirements staff officers (RSO) work with PEGs to ensure that funded programs have a clearly definable and documented link to military requirements or leadership designated capabilities. Together, PEGs and their RSOs attempt to strengthen linkages of programs meeting this criterion and to terminate those failing to do so. From January, when formal preparation of the program gets under way, through April, these efforts continue during deliberations to approve the individual MDEPs that make up each PEG program. The aim is to make sure the unfolding PEG program links to validated military requirements and leadership-designated capabilities.

c. If unresolved at the PEG level, a program earmarked for termination is forwarded through the ADCS G-3/5/7 to the PPBC for decision.

#### 8-33. Army Research, Development, and Acquisition Plan

The G-8 with the ASA (ALT) prepares the Army Research, Development, and Acquisition Plan (RDAP) to analyze requirements for battlefield and infrastructure capabilities and rank those requirements in priority order. The RDAP matches the requirements to materiel solutions, that is, to RDT&E and procurement programs.

a. The RDAP is a 15-year plan for developing and producing technologies and materiel to advance Army modernization. Imposing mandatory TOA controls, the plan restricts modernization to those efforts that are both technically and fiscally achievable. The process truncates requirements developed through unconstrained planning into an RDA program that, within limited resources, maximizes warfighting capabilities and supporting infrastructure.

b. The RDAP is represented by the G-8 RDA database called Force Development Information and Integration System (FDIIS). FDIIS provides information to the RDA program as a required set of MDEPs arrayed in 1-n order by G-8 and ASA (ALT). Each MDEP describes a program, function, or organization and the dollars and system quantities needed. It not only covers the 5-year FYDP but also the 9-year EPP.

c. A continuous process, the RDAP focuses on periodic revisions to the RDA database. Revisions typically occur during preparation of the CY combined POM / BES (Feb to Aug) and the PB (Sep to Jan). During these periods, HQDA adjusts the FYDP years, or first 5 years of the RDAP. Then, the Army's RDA community adjusts the final 9 years making sure progression from POM / BES to the PB and EPP is not only affordable, but also executable.

d. Each December, TRADOC provides HQDA its recommendations on materiel requirements, arriving at the recommendations through a Capability Needs Analysis (CNA). The process takes into account such guidance as the NMS and the TAP, the AEMS, and IPLs of the CCDRs. The CNA compares future capabilities required by the total force against the fiscally constrained budgeted force. The comparison determines force modernization needs that TRADOC rank orders according to their contribution to mission accomplishment.

## Section IX

### Integrated Programming-Budgeting Phase

#### 8-34. Army Programming and Budgeting

An integrated decision process, Army programming-budgeting produces a combined POM / BES. In conjunction with OSD review, Army integrated programming and budgeting supports development of the

PB. Once the PB goes to Congress, the Army presents and defends its portion of the budget in congressional hearings.

### 8-35. Guidance

a. The primary product of the OSD planning phase is the DPG which provides key strategy, policy and limited programmatic guidance to the services and defense agencies.

b. TGM. G-8's DPAE complement the APGM with a TGM outlining program intent with respect to allocating resources to attain the Army vision. The TGM also provides coordinating instructions to guide PEGs during the POM / BES build. Additional, PEG-by-PEG guidance lays out programming priorities for specific programs set by the SECARMY and CSA and, for some programs, specifies a particular level of funding.

c. FG. Before completion of the POM / BES build, OSD issues FG establishing the Army's TOA over the PYs. DPAE then apportions the TOA to the PEGs for building their portion of the program. The guidance includes inflation factors and other administrative instructions.

d. PBG. DPAE issues PBG typically twice each year, after forwarding the combined POM / BES to OSD for review and after the PB is forwarded to Congress. An enterprise product, the PBG is produced jointly by ASA(FM&C)'s Budget Formulation Division (SAFM-BUC-F) and the G-8's Program Budget Data Management Division (DAPR-DPI) in coordination with G-3/5/7's Force Accounting and Documentation Division (DAMO-FMP). The PBG provides resource guidance to major ACOMs, PEOs, and other operating agencies. Narrative guidance instructs commands and agencies, in addressing resource requirements, such as those related to flying hours, ground operating tempo (OPTEMPO), and rates for fuel, inflation, and foreign currency. A related automation file reflects the resource status of each command and agency. Commands and agencies use their PBG resource information to update their databases for the forthcoming PPBE cycle.

f. Integrated Program-Budget Data Call. HQDA publishes a multivolume Resource Formulation Guide (RFG) to facilitate the PPBE process. Issued in the fall, RFG volume 3 (Integrated Program-Budget Data Call) describes the data ACOMs, PEOs, and other operating agencies must submit to HQDA to prepare the POM / BES. Commands and agencies may propose changes to their resources over the PYs. Volume 3, however, requires that changes remain zero-sum within the command or agency.

g. Programming Data Requirements. Before each POM submission, OSD updates a web-based manual entitled Programming Data Requirements (PDR). The PDR provides instructions for preparing and submitting data, requirements, and program justifications to support component POMs. Prescribing formats and exhibits, its instructions describe programming data requirements and some budgeting data, which components submit using OSD's Select and Native Programming (SNaP) Data Collection System.

h. POM Preparation Guidance. As required, HQDA issues RFG volume 4 augmenting OSD PDR with additional guidance for preparing the POM.

i. BES Preparation Guidance. Two OSD budget guidance documents affect content of the BES. Volume 2 of the DOD Financial Management Regulation prescribes various exhibits and displays to be used in presenting the budget. The Annual Budget Call Memorandum provides supplemental information such as current rate and pricing guidance. Complementing these documents, ASA (FM&C) also issues administrative instructions for preparing the Army's BES.

### 8-36. Army Resource Framework

The Army Resource Framework Hierarchy shown in Figure 8-11 is designed to organize the Army's resources in a consistent manner to facilitate resource decision-making in all PPBE cycles.

### 8-37. Program Objective Memorandum Preparation

a. Start-Up. The annual integrated programming-budgeting phase of the process starts in Oct as OSD reviews the recently forwarded change proposals. In developing the Army program, programmers translate planning decisions, OSD programming guidance, and congressional guidance into a comprehensive allocation of forces, manpower, and funds. In doing this they integrate and balance centrally managed programs for manpower; operations; research, development, and acquisition; and stationing and construction. Concurrently, they incorporate requirements presented by ACOMs, PEOs, and other operating agencies for manpower, operation and maintenance, housing, and construction.

b. Initial Programmatic Review. From October through December, HQDA-

(1) Reviews the existing program to determine program deficiencies.

## Army Resource Framework Hierarchy

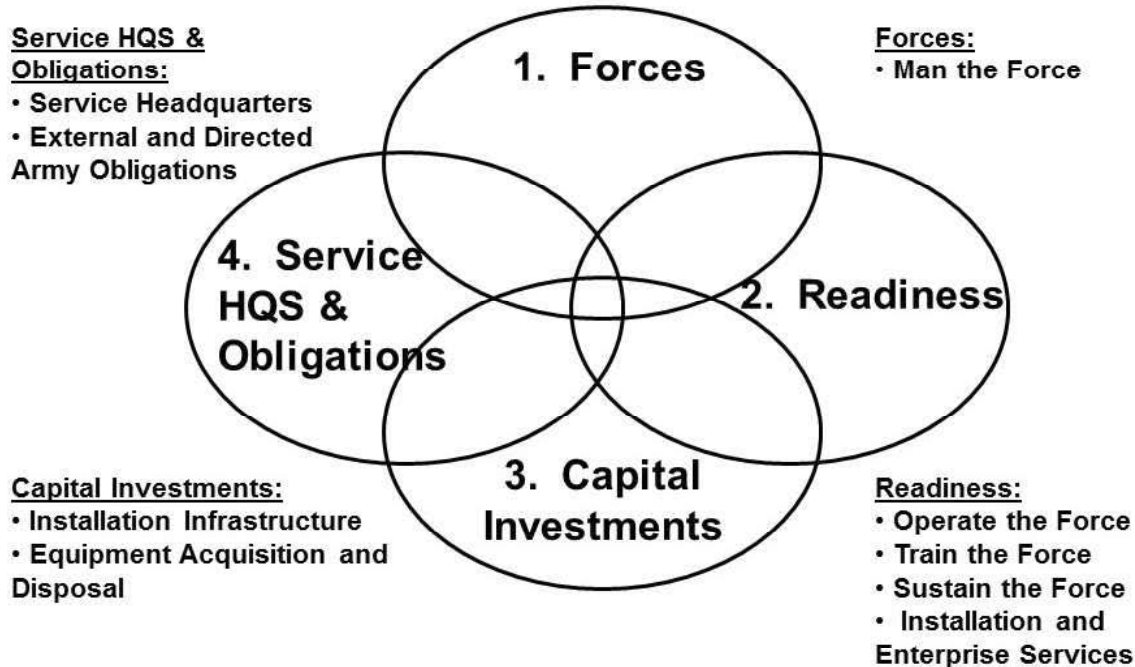

Source: Army Program Guidance Memorandum (APGM), 16 March 2015

Figure 8-11. Army Resource Framework Hierarchy

- (2) Sorts existing MDEPs by PEGs.
  - (3) Establishes force structure and civilian manpower authorizations.
  - (4) Responds to changes recorded in and IPs generated by the OSD program and budget review.
- c. Preparing the Database.
- (1) Formal preparation of the POM / BES starts once the PB goes to Congress. This usually occurs after the first Monday in January but not later than the first Monday in February. As a start point, DPAE establishes a base file in the PPBE database that reflects the PB resource position. Afterwards, in a series of zero-sum adjustments that leave resource levels in the PB unchanged for the BYs, HQDA revises the database. The adjustments—
    - (a) Update earlier estimates with new information and revise them for inflation.
    - (b) Move resources between and among current AMSCO and MDEP structures.
    - (c) Consolidate or otherwise restructure individual programs through rolls and splits to make the overall Army program more manageable.
    - (d) Re-price existing programs as needed and, when required by modified resource levels, identify offsetting deductions as bill payers.
  - (2) Figures 8-12, 8-13, and 8-14 show timelines for POM / BES, PPBE, and Program & Budget.

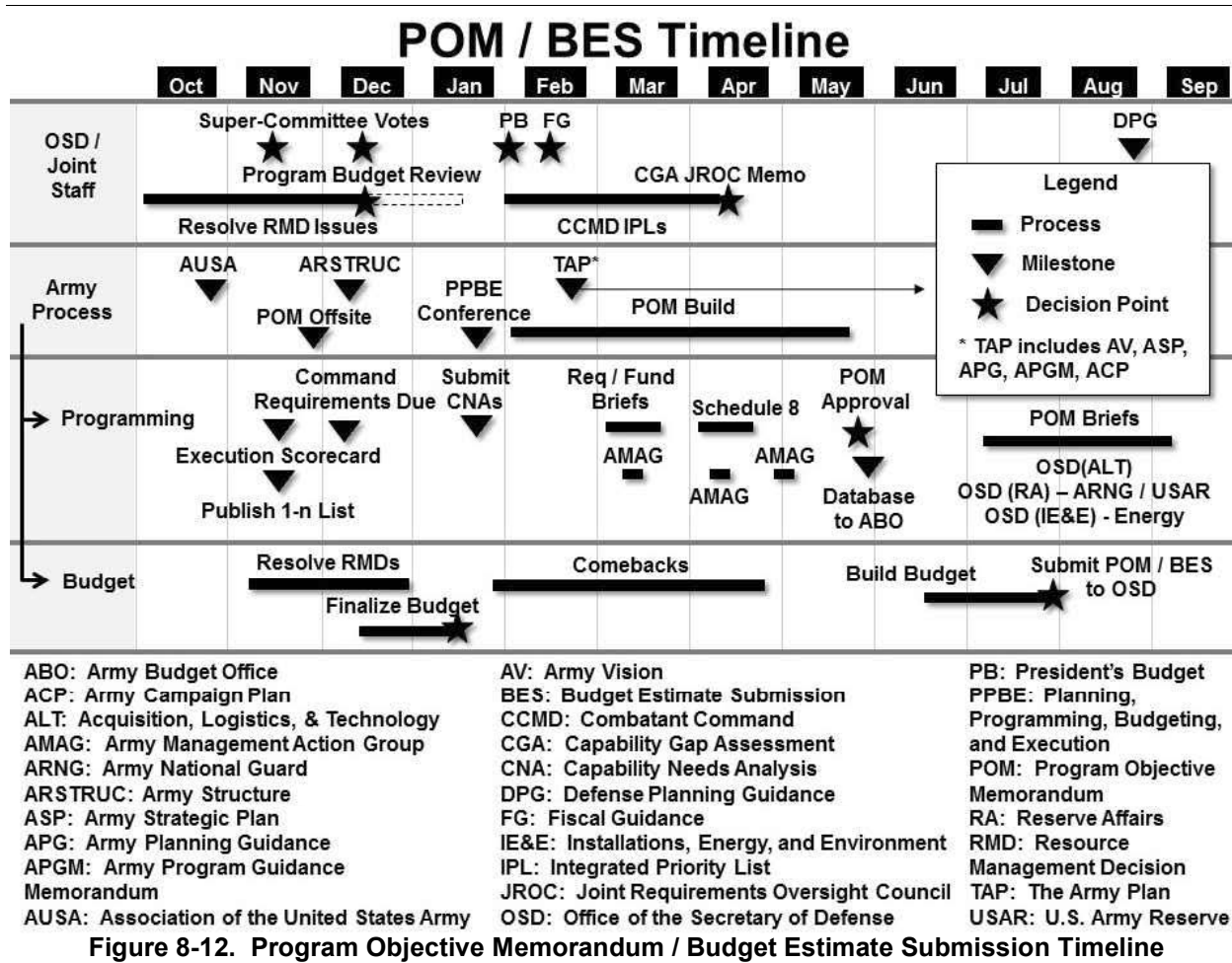

d. Command participation. ACOMs participate in the PPBE process as do PEOs, which report through the Army Acquisition Support Center (ASC). These and other operating agencies make mission and operating requirements known through Commander's Narratives, Command-Requested Changes, and additional data submissions prescribed by RFG volume 3. ACOM commanders serving as commanders of ASCCs integrate operational requirements of the CCMD into their program and budget input. In addition, CCDRs highlight their pressing requirements in an IPL that receives close review during program development by HQDA, the JS, and OSD.

e. Use of PEGs.

(1) As mentioned, HQDA packages program requirements into MDEPs, each associated with one of six resource management areas. HQDA then assigns each MDEP to a PEG to help build and track the Army POM that forms the Army portion of the DOD FYDP.

(2) PEG POM-building activity begins in the fall and peaks March through May of the following year.

(3) PEGs administer assigned MDEPs. They set the scope, quantity, priority, and qualitative nature of resource requirements that define each PEG program. They monitor PEG resource transactions, making both administrative and substantive changes to their MDEPs as required. In the process, PEGs review assigned MDEPs in terms of TOA guidance. They review command and agency requested requirements submitted via Schedule 1s and their POM. At the same time, PEGs review IPLs of the CCMDs as well as resource needs expressed by the supporting ASCC. PEGs relate these command operating requirements to HQDA guidance as well as to existing MDEPs and new initiatives.

(4) Meanwhile, program integrators provide technical assistance to the PEGs and monitor actions to integrate priorities and statutory, defense, and Army requirements for their respective programs.

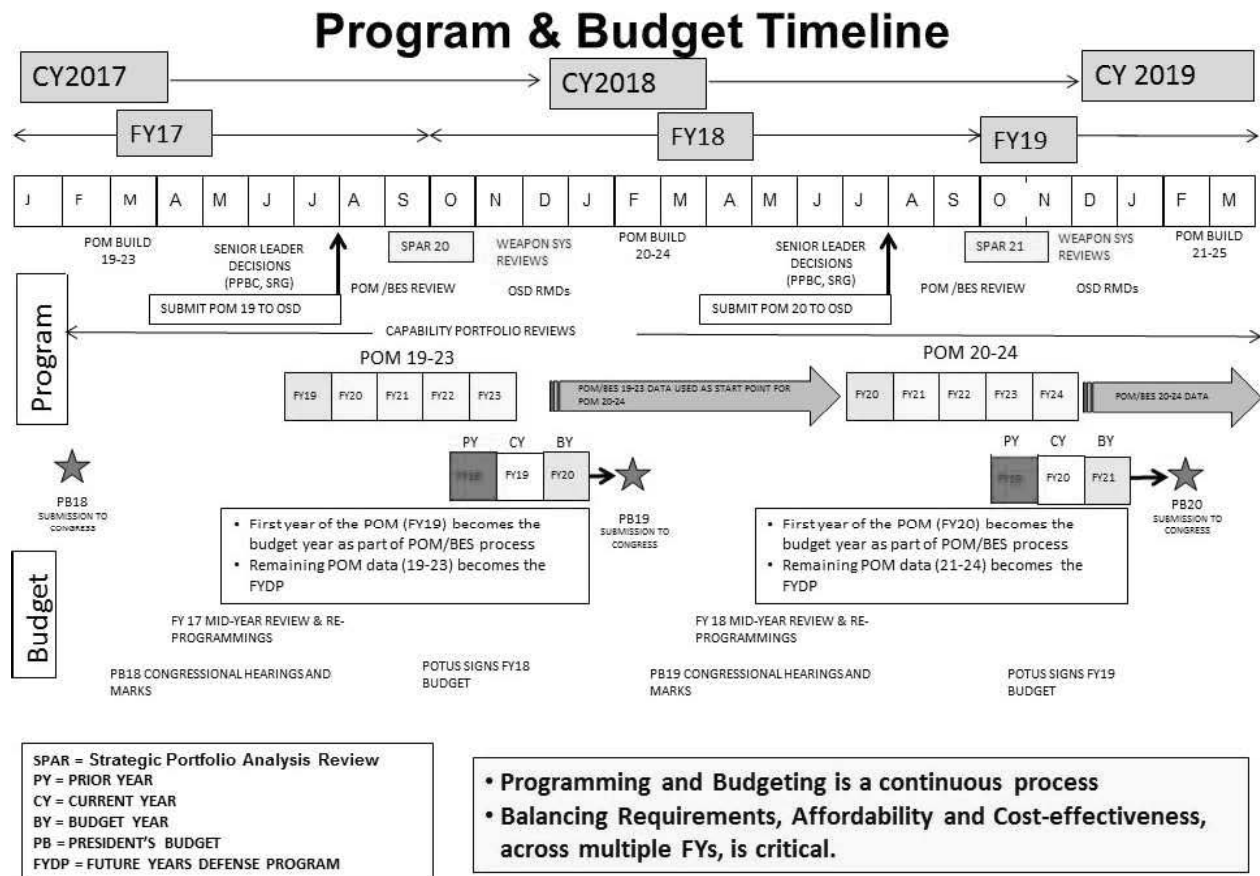

Figure 8-13. Planning, Programming, Budgeting, and Execution Timeline

- (5) Based on review of military requirements related to their Title 10 area of responsibility, each PEG builds an executable program characterized by affordability, continuity, and balance. In the process, the PEG—
- Validates requested changes submitted by ACOMs, PEOs, and other operating agencies.
  - Reconciles conflicts involving unfunded requirements or decrements on which commands fail to reach agreement.
  - Recommends the allocation of available resources and offsetting decrements to support approved unfunded programs.
  - Rank orders validated programs as PEG input to G-3/5/7's overall POM 1-n prioritized program list.
  - Evaluates HQDA, command, and other agency zero-sum realignments that reallocate programmed resources to meet existing shortfalls and changed requirements.
  - Coordinates resource changes with appropriate Service, DOD, and non-DOD agencies when required.
  - Makes sure that proposed reallocations conform to legal restraints and Army policy and priorities, avoid imprudently high risk, and maintain the ability to execute mandatory programs and subprograms.
  - Prices programmatic decisions that the Army can defend during review by OSD, OMB, and the Congress.

## Program and Budget Timeline

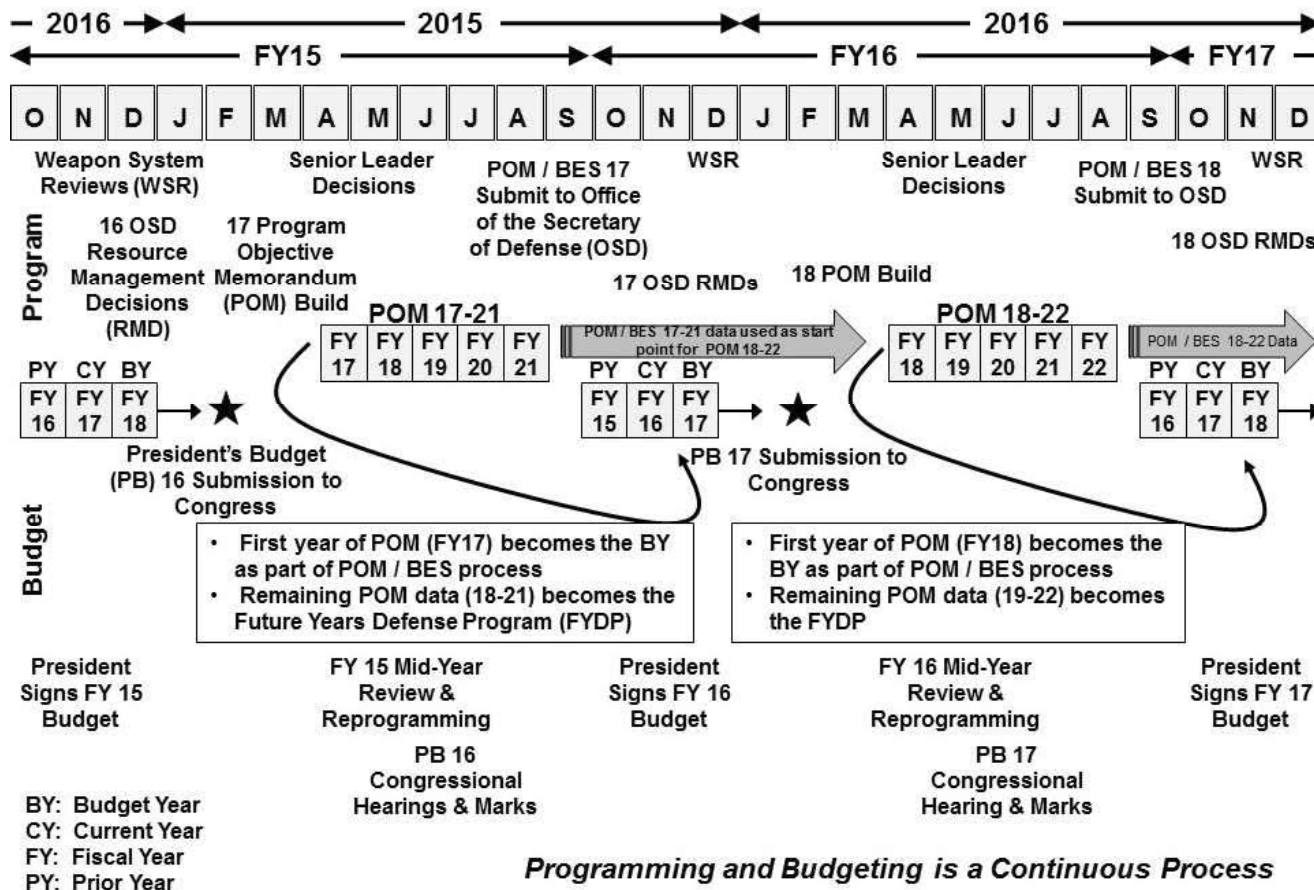

Figure 8-14. Program & Budget Timeline

f. Internal Program Review. The PPBC meets periodically throughout the POM / BES build to review and adjust the developing program, devising courses of action and recommendations on relevant issues as appropriate. The Senior Review Group (SRG), in turn, convenes early in the process to approve guidance and, at key stages, to ratify PPBC decisions.

g. POM. The annual POM, which documents the program decisions of the SECARMY as influenced by the CSA's recommendations, presents the Army's proposal for a balanced and integrated allocation of its resources within specified OSD fiscal and manpower constraints. POM subject matter remains relatively constant from cycle to cycle, but varies as required to address special issues. The FY 2017-2021 POM included an introduction and discussion of forces, investment, operations and support, infrastructure-environmental, infrastructure-defense agencies, manpower and personnel, Defense Working Capital Fund, and CCDR IPLs.

### 8-38. Program and Budget Correlation

The POM defines what the Army intends to do over the 5-year program period. It uses the MDEP to package required resources by mission, function, and other program objectives. Throughout program development, however, both programmers and budgeters make sure that programmatic decisions receive proper costing and that Army resource decisions can be defended during budget reviews conducted by OSD, OMB, and Congress. Working closely together, programmers and budgeters help the senior Army leadership consider all relevant information before the leaders make resource allocation decisions. The approach precludes the need, later in the integrated process, to revisit most issues. Moreover, it presents a near seamless transition from program to budget.

## 8-39. Budget Estimate Submission Preparation

a. HQDA prepares the BES concurrently with the POM, historically submitting the combined POM / BES to OSD in August every year. Beginning with the FY17 submissions, the POM/BES will be submitted in mid-July with a target submission date of mid-June for submissions beginning in with the FY18 submissions. The BES covers the first year of the program approved by the SECARMY and CSA.

b. One or more events may cause HQDA to re-address certain POM / BES decisions. For example, during program-budget preparation, Congress reviews the budget for the upcoming FY. The review requires that the Army track resultant Congressional actions and make appropriate adjustments in the BES. Also, after completing the POM, changes occur in rates and prices available during POM build. The later information often requires altering such rates and prices as those for the Army Working Capital Fund, pay, fuel, or inflation.

## 8-40. Office of the Secretary of Defense Program and Budget Reviews

OSD begins review of the combined POM / BES soon after their submission. The Program Review is conducted until Oct-Nov followed by the Budget Review which continues until late December. The review concludes when the administration makes final PB decisions.

a. Issues center on compliance with the DPG, the overall balance of service programs, and late-breaking significant issues.

b. As issues arise, representatives of HQDA principal officials meet with their OSD counterparts. The Army representatives present the Army position and try to clarify the issue. If possible, the issue is resolved at this level.

c. Upon completion of the Program Review, after review officials have debated and decided program issues, the DEPSECDEF issues one or more RMDs directing specific changes to program positions of the submitted POM. After the Budget Review and before completing the budget, if it is needed, the DEPSECDEF publishes a Summary RMD along with a memorandum describing the disposition of programmatic issues.

d. Budget issues are decided through draft IPs. Focusing on proper pricing, reasonableness, and program execution, an IP may be based on errors or on strength of justification. It may result from analytical disagreement or, it may be motivated by cost savings or changes in policy. After reviewing the IP responses, the SECDEF issues RMDs which are final decisions directed by the SECDEF telling the services to change their program requests to align them with the SECDEF's decisions.

e. After the DEPSECDEF or USD (C) has signed the RMDs, each service selects as MBIs certain adverse resource decisions. Army MBIs center on decrements to specific initiatives or broad issues that would significantly impair its ability to achieve its program intentions. An MBI addresses the adverse impact that would occur if the decrement were to prevail. At the end of the process, the SECARMY and CSA meet with the SECDEF and DEPSECDEF on MBI. After the meeting, the SECDEF decides each issue, if necessary meeting with the OMB or the President to request additional funds or recommend other action.

## 8-41. President's Budget

a. In December, OSD normally issues a final RMD, an OSD memorandum incorporating any changes from deliberations on MBI, thus completing the review process.

b. After implementing the final resource distribution at the BA and object class level, Army sends the information to OSD. OSD forwards the information as the Army's portion of the Defense budget to OMB and OMB incorporates the Defense budget into the PB. The PB covers PY obligations and updated resource estimates for the CY. During the annual POM/BES cycle, the PB covers TOA estimates for the BY.

## 8-42. Justification

a. Congressional Budget Hearings.

(1) During budget justification, the Army presents and defends its portion of the PB before Congress. The process proceeds formally and informally under the staff supervision of the Chief of Legislative Liaison and ASA (FM&C).

(2) After the President formally submits the budget, the Army provides detailed budget justification to the authorization and appropriations committees. First, however, appropriation sponsors will have

prepared material in Army justification books to conform to decisions of the President and SECDEF and congressional requirements for formats and supporting information. Justification books undergo internal Army review by ASA (FM&C) and are then sent to OSD for final review.

(3) The Senate Armed Services Committee (SASC) and House Armed Services Committee (HASC) conduct authorization hearings for the various programs and appropriations. Concurrently, the Army's budget request goes before the Senate Appropriations Committee (SAC) and House Appropriations Committee (HAC). In these hearings, the SECARMY and CSA normally testify first. Then with assistance from ASA (FM&C)'s Budget Liaison Office and the Office, Chief of Legislative Liaison (OCLL), appropriation sponsors and functional proponents present and defend the details of the budget.

b. Legislative approval and enactment.

(1) When Congressional committees complete their review, the Senate and House vote on the committee bills. Differences between the Senate and House versions are resolved in joint conference.

(2) Budget justification ends when the President signs the authorization and appropriation bills for the coming FY. Enacted into law, Army appropriations provide the legal authority to incur obligations and make payments.

c. Continuing Resolution Authority (CRA). When Congress fails to pass an appropriation by the end of September, it may pass a continuing resolution. CRA derives from emergency legislation that authorizes the funding of government operations in the absence of appropriations. A temporary measure, the CRA usually restricts funding to the PY level and prohibits new initiatives. HQDA separately publishes specific policy on how the Army will operate under the CRA. Failure to pass either an appropriation or CRA could result in a temporary shutdown of government operations. Normally, however, until an appropriation or CRA is enacted, DOD would continue minimum essential operations based on national defense requirements.

### Section X

#### Army Budget Execution Phase

##### 8-43. Management and Accounting

During execution, the Army manages and accounts for funds and manpower to carry out approved programs. The Army checks how well HQDA, ACOMs, PEOs, and other operating agencies use allocated resources to carry out program objectives. Through the Army Joint Reconciliation Program, the Army strengthens financial accounting and management to make sure financial reports accurately reflect the results of budget execution. The Army, OSD, OMB, and Congress apply execution feedback to adjust resource requirements during deliberation on the Army's budget.

##### 8-44. Financial Management

The budget execution process applies funds appropriated by Congress to carry out authorized programs. This process first entails apportioning, allocating, and allotting funds. It then entails obligating and disbursing the funds and then reporting and reviewing the effectiveness of executing them. The procedure also involves performing in-progress evaluations and making necessary course corrections to reallocate resources to meet changing requirements that develop during execution. Known as reprogramming, making course corrections involves financing unbudgeted requirements that result from changed conditions unforeseen when submitting the budget and having higher priority than the requirements from which funds are diverted.

a. Funds Control.

(1) The OSD-level Enterprise Funds Distribution (EFD) system is a web-based system which combines Congressional tracking with funds distribution to the Army and contains specific instructions on funds control. EFD has standardized funding authorization documents (e.g., Obligation Authority (OA) letters, DD440 documents, DD460 documents and annual operating budget for Working Capital Funds appropriated funding). The three ERP systems provide the Army an integrated enterprise-wide system to provide decision-makers with better data and to comply with legal and mandatory reporting requirements. As "mixed systems," these three systems perform financial management functions to better support their primary missions and system functions. The ERP systems include—



## ARMY PLANNING, PROGRAMMING, BUDGETING, AND EXECUTION PROCESS

(a) General Fund Enterprise Business System (GFEBS). GFEBS is a Chief Financial Officers Council-certified commercial-off-the-shelf (COTS) Enterprise Resource Planning (ERP) system that provides the Army and DOD relevant, reliable, and timely financial information across the full spectrum of operations. GFEBS distributes funds to the various commands, tracks the execution of funds, and provides functionality in six core financial areas: general ledger management; payment management; receiving management; funds management; cost management; and reporting. GFEBS is helping the Army standardize and streamline its financial business processes to provide continuous access to financial information, as well as contribute an important element in the development of an Army integrated enterprise-wide system. GFEBS is designed to integrate seamlessly into the Army's IT environment, and also includes significant business process reengineering, change management, and business case analysis support components. GFEBS processes financial, real property, cost management, and performance data, and then integrates this data for decision support. GFEBS' primary objectives include improving performance; standardizing financial and business processes; ensuring capabilities exist to meet future needs; and complying with statutory and regulatory accounting requirements. Specifically, GFEBS' goals are as follows: provide decision support information to sustain Army capabilities; provide analytic data and tools to support institutional adaptation; reduce the cost of business operations; and improve accountability and stewardship.

(b) Logistics Modernization Program.

(c) Global Combat Support System-Army.

(2) Several events must occur before the Army can execute its programs for a new FY under a new appropriations act:

(a) OMB must apportion the appropriations, which provides obligation / budget authority. An apportionment distributes funds by making specific amounts available for obligation.

(b) The Department of the Treasury must issue Treasury Warrants providing cash in the Army's checking account.

(c) The USD (Comptroller) must release program authority.

b. Apportionment.

(1) An apportionment requires a specific request. Using SF 132, Apportionment and Reapportionment Schedule, the ASA (FM&C) Funds Control Officer (SAFM-BUC-E) prepares the request within 5 days of the availability of an appropriations act or in response to approved reprogramming requests, supplementals, or rescissions. OSD approves or revises the apportionment requests and submits them to the OMB for approval. OMB approves, changes, or disapproves the requests and returns apportionments through OSD to the Army for entry into GFEBS. OMB apportions the following:

(a) Operating Accounts-Operation & Maintenance (O&M), Military Personnel (MILPERS), and Army Family Housing, Operations (AFHO)-on a fiscal quarterly basis

(b) Investment accounts-RDT&E, Procurement, Military Construction (MILCON), and Army Family Housing (Construction) (AFHC))-at the start of the FY rather than on an incremental basis, funding the entire amount of the appropriation.

(2) The apportionment determines the Budget Authority (BA) available in GFEBS. For the operating accounts-even after releasing the entire program to the command-it is the cumulative amount of BA issued to commands and agencies by quarter that determines the execution level for the appropriation.

c. Program Release.

(1) For investment accounts, the Army releases program and budget authority in equal amounts. Actual expenditure, however, depends on OSD program controls wherein the USD (Comptroller) gives the Army specific program releases that further control expenditures.

(a) For the RDT&E appropriation, the program is released at the PE level (SD Form 440, RDT&E Program/Fund Authorization). These are the same levels as those authorized and appropriated by Congress and reported in the DD Form 1414, Base for Reprogramming Actions and DD Form 1416, Report of Programs, which are provided to Congress to show execution changes to appropriated amounts.

(b) For the procurement appropriations (Aircraft, Missiles, Weapons & Tracked Combat Vehicles, Ammunition, and Other Procurement), the program is released at the budget line item (BLIN) level (SD Form 440).

(c) Both the MILCON and the AFHC appropriations are released at the project level (OSD Format 460 for Military and Family Housing Construction accounts) as contained in the conference report accompanying the Military Construction Appropriations Act.

Program releases for the operating accounts (Operation and Maintenance (O&M) and Military Personnel (MILPERS)) are contained in the obligation authority (OA) letter issued by the USD (Comptroller). OSD issues a separate OA letter for Army Family Housing (Operations) (AFHO).

d. Allocation, Obligation, and Reconciliations. Guided by HQDA appropriation sponsors and using the GFEBS, ASA (FM&C) allocates apportioned funds to commands and agencies. Then:

(1) ACOMs and other operating agencies, in turn, make funds available to subordinate commands and installations by an allotment. Allotments authorize users to place orders and award contracts for products and services to carry out approved programs.

(2) Installations obligate funds as orders are placed and contracts awarded. They authorize payments as materiel is delivered or as services are performed.

(3) Installations, commands, and appropriation sponsors conduct joint reconciliations. Reconciliations make sure financial statements and reports accurately represent the results of the apportionment, allocation, and allotment program. Reconciliations also make sure payments align properly with supporting obligations. The Deputy Assistant Secretary of the Army (Financial Operations) (SAFM-FO) manages the Army's Joint Reconciliation Program.

e. Changes from the PB. After appropriations are enacted, appropriation sponsors and the Army Budget Office review the legislation to determine changes to the submitted budget. Changes include congressional adds, denial of programs, and changes to submitted funding levels. Changes also include identification of congressional special interest items, undistributed reductions, and any language relating to execution of the programs. Army applies such changes to amounts loaded into the GFEBS. Appropriation sponsors must determine how to spread any undistributed reductions. In addition, they may also have to spread some unapplied reductions in the appropriations act, which are distributed to the Services (and appropriations) during the program review cycle using IPs that challenge the service programming requests. For those reasons, the actual funding level for a particular project, BLIN, PEs, APEs, or BA may not be finally set until several months into the new FY. This is so even if the appropriations act is passed before October 1, and the ultimate initial funding level for individual programs will almost certainly be less than shown in the joint conference reports.

f. Funding Letters for Operations and Maintenance (O&M) and Army Family Housing (Operations) (AFHO). HQDA issues funding letters to commands and agencies for the OMA and AFHO appropriations. The ARNG and USAR issue their own funding letters for their O&M appropriations. The letters indicate funded programs and give guidance on how the programs should be executed. The funding letters also provide an audit trail from the resource position in the PB to the revised, appropriated position. The OMA letter outlines the funding posture and goals set by the senior Army leadership for command execution. Preparing and issuing the funding letter takes about 60 days after the appropriations act is passed.

### **8-45. Revised Approved Program for Research, Development, Test, and Evaluation**

HQDA issues a Revised Approved Program (RAP) for the RDT&E appropriation. The RAP shows Congressional changes at both the PE and project level. In addition, the RAP spreads general reductions at the project level. It includes the amounts set aside for the Small Business Innovation Research Program (SBIR) and the Small Business Technology Transfer Pilot Program (STTR). The RAP also includes amounts withheld by the USD (C) and HQDA and provides language on Congressional restrictions and special interest items. Because of the level of detail and the extensive information included, the RAP does not become available until several months after the appropriations act is enacted.

### **8-46. Obligation and Outlay Plans**

a. During December and January, ASA (FM&C), in coordination with field activities and appropriation sponsors, develops obligation plans for each appropriation. Outlay plans are developed unilaterally at the ASA (FM&C) level. Obligation plans address unexpired funds. Outlay plans address unexpired, expired and no-year funds.

b. ASA (FM&C) sends completed outlay plans to the USD (C). Although the USD (C) discontinued a requirement to submit obligation plans, the Army continues their use internally since OSD still reviews Army obligation rates and requests rationale for execution rates that fall outside normal parameters.

c. The Transparency Process and the Secure Sheet process provide visible and auditable requirements, acquisition cycle and delivery of equipment to Congress. This system tracks the funding and procurement quantities from request through delivery to the unit. It also tracks the changes and capture the reasons and justifications for adds and / or decrements to component level allocations. It tracks the changes to distributions to include the reasons and justifications for how the increases / decreases were applied to component level allocations.

d. Based on command estimates of annual obligations, both obligation and outlay plans tie to obligation and outlay controls in the PB. The importance of the outlay plan is that it relates directly to the projected amounts the Treasury must borrow to maintain proper balances to meet expected disbursements (outlays).

## 8-47. Financing Unbudgeted Requirements

a. Congress recognizes the need for flexibility during budget execution to meet unforeseen requirements or changes in operating conditions, including those to address minor, fact-of-life financial changes. Congress accepts that rigid adherence to program purposes and amounts originally budgeted and approved would jeopardize businesslike performance or mission performance. Thus, within stated restrictions and specified dollar thresholds, Congress allows federal agencies to reprogram existing funds to finance unfunded requirements. Typically, reprogramming diverts funds from undertakings whose requirements have lower priority than the new requirements being financed.

b. Congressional reprogramming language specifying budget authority limits, which varies by appropriation, controls the Army's ability to move budget authority within appropriations (below threshold reprogramming). Moving the program in excess of specified limits requires Congressional approval via a formal reprogramming request (DD Form 1415, Reprogramming Action). Moving amounts between appropriations (transfer authority) always requires a formal reprogramming request.

c. Provided reprogramming authority is not required, another way to finance unfunded requirements is to apply obligation authority harvested from joint reconciliations. This means using unexpired funds originally obligated against a contract or order but identified as excess to the need and subsequently de-obligated. Reutilizing funds in this way gives allotment holders greater leverage in executing the budget and increases the buying power of the Army's financial resources.

d. The Omnibus Reprogramming procedure consolidates all non-emergency DOD prior approval reprogramming actions, except for construction accounts, into one very large reprogramming action. It identifies all DOD reprogramming requirements at one time. This allows the Congress and DOD to set priorities for limited funding and to make smarter decisions.

## 8-48. Oversight of Non-Appropriated Funds

Applying various methods, the ASA (FM&C) also oversees non-appropriated funds (NAF). One method is by participating on the Morale, Welfare, and Recreation (MWR) Board of Directors. The Deputy Assistant Secretary of the Army (Financial Operations) is a voting member of the MWR Executive Committee. In addition, the Principal Deputy Assistant Secretary of the Army (FM&C) chairs the Audit Committee, and the Chief Resource Analysis and Business Practices serves on the Investment Subcommittee. Through these positions the ASA (FM&C) influences virtually all aspects of MWR financial policy. As part of the responsibility of overseeing NAF, the ASA (FM&C) presents NAF issues to the SECARMY and CSA for decision.

## Section XI

### Program Performance and Review

## 8-49. Program Implementation

ACOMs, PEOs, and other operating agencies carry out the approved program within manpower and funds provided. They review budget execution and account for and report on the use of allocated funds by appropriation and MDEP. As applicable to each appropriation, they include FYDP program and

subprogram, AMSCO, APE, project number, BLIN, SSN, BA, BAG, and EOR. They also account for use of allocated manpower by UIC. The manpower and financial data obtained help commands and agencies develop future requirements.

### 8-50. Performance Assessment

a. ASA (FM&C) oversees the Cost & Performance Portal (CPP) which collects Army financial and performance data from disparate Army data systems, centralizes the data into a single data warehouse, and displays analytic information through various reports and graphical displays. The CPP is accessible to all Army users including resource managers, functional experts, and senior leaders through web-based interfaces with the ability to login via the Army cost accounting codes (CAC).

b. The CPP provides real-time, relevant, accurate and transparent financial and performance information to senior leaders and HQDA staff to support decision-making.

### 8-51. Review of Selected Acquisition Systems

The means for checking system program performance include milestone reviews of designated acquisition programs conducted by ASA(ALT) using the ASARC and Major Automated Information Systems Review Council (MAISRC).

### 8-52. Joint Reconciliation Program

This program applies the skills of those responsible for various aspects of financial management. The skills include those of accountants, budget and program analysts, contracting professionals, logisticians, and internal review auditors. The program applies these combined skills to verify the validity of unliquidated obligations, contractor work in progress, billing status, and the continued need for goods and services not yet delivered. The program achieves dollar savings by identifying and canceling obligations for goods and services no longer needed or duplicative. The program also reconciles current appropriations to verify the correctness of amounts obligated. In addition, the program assures the liquidation of appropriations to be canceled by the end of the FY.

## Section XII

### Summary, Key Terms, and References

#### 8-53. Summary

The PPBE process ties strategy, program, and budget all together. It helps build a comprehensive plan in which budgets flow from programs, programs from requirements, requirements from missions, and missions from national security objectives. The patterned flow from end purpose to resource cost defines requirements in progressively greater detail.

#### 8-54. Key Terms

a. *Program Objective Memorandum*. The final product of the programming process within the DOD, the DOD Component's POM displays the resource allocation decisions of the Military Departments in response to and in accordance with planning and programming guidance (DODD 7045.14).

b. *Future Years Defense Program*. Program and financial plan for the DOD as approved by the Secretary of Defense. The FYDP arrays cost data, manpower, and force structure over a 5-year period (force structure for an additional 3 years), portraying this data by major force program for DOD internal review for the program and budget review submission. It is also provided to the Congress annually in conjunction with the President's budget (DODD 7045.14).

#### 8-55. References

- a. DODD 7045.14 Implementation of the Planning, Programming, and Budgeting System.
- b. CJCS Instruction 3100.01B, Chairman's JSPS.
- c. AR 1-1, PPBE Process.

## Chapter 9

### Resource Management

#### Section I Introduction

##### 9-1. The Need for Resource Management

a. Resource management (RM) is the direction, guidance, and control of financial and other resources. It involves the application of programming, budgeting, accounting, reporting, analysis, and evaluation. The 2018 APS and 2011 SECARMY Memo, "Consideration of Costs in Army Decision-Making," emphasize the need for effective RM throughout the Army. Because the Army has a large and complex set of missions to execute and a limited set of resources with which to accomplish its missions and supporting tasks, the necessity to maximize the spending power of every dollar the Congress appropriates to the Army becomes paramount. Further, because the Army is vested with the public's trust and confidence for defending the Nation, all Army leaders have an incumbent responsibility to exercise effective and responsible stewardship for all the resources that have been entrusted to them. As such, responsible, effective, and efficient RM is an integral part of all Army leaders' duties and functions and is essential for maintaining the Army's readiness to accomplish its assigned missions.

b. RM at the strategic level must address the issues of affordability, required force capabilities, and the entire supporting structure. Resource managers at this level must also deal with the larger questions of whether particular programs are needed, how they serve the specific missions assigned to the Army, and whether the strategies designed to accomplish the mission are correct and necessary. Programmatic and financial resource perspectives examine the efficiency with which funds are allocated and spent and how effectively particular programs are managed and integrated. At the program level this process encompasses the ways in which the Soldiers, civilians, facilities, equipment, information, time, and funds are integrated into the Army.

c. Implicit in this programmatic RM perspective is the recognition that everyone participates in a resource decision stream that requires some of these decisions, once made, to remain unalterable. For example, placing a new facility at an installation typically requires a minimum of two or more years. The time to train instructors and then Soldiers on a new piece of equipment varies with the complexity of the equipment. Ordering the secondary spares for new end items requires time. Integrating all three of these resource decisions requires that the irreversibility of the decision must be considered; otherwise, new facilities could be constructed at one installation for a new piece of equipment and for Soldiers to be trained on that equipment, while the equipment and Soldiers have actually been placed on another installation.

d. More importantly, this unalterable decision base creates a receivables stream such as aircraft, training packages, equipment shops, displaced equipment, and so forth of substantial proportion. Reconfiguring these receivables without considering the previous decision rationale may well create RM disconnects which tend to surface in OSD resource review forums and congressional hearings.

##### 9-2. Key Players in Army Resource Management

a. Congress. Central to the function of obligating the Government to make a payment is the power invested by the U.S. Constitution in the Congress for the following: to raise revenue and borrow money (U.S. Constitution Article I, Section 8, Clause 1-2); to raise and support armies; and to provide and maintain a navy (U.S. Constitution Article I, Section 8, Clause 12-13), and no money shall be drawn from the Treasury but in consequence of appropriations made by law (U.S. Constitution Article I, Section 9, Clause 7). To meet these requirements Congress passes authorization and appropriation acts as described above.

## HOW THE ARMY RUNS

b. Office of Management and Budget (OMB). OMB assists the President of the United States (POTUS) in overseeing the preparation of the federal budget and in supervising its administration in federal agencies. It evaluates, formulates, and coordinates management procedures and program objectives within and among federal departments and agencies. It also controls the administration of the federal budget, while routinely providing POTUS with recommendations regarding budget proposals and relevant legislative proposals. Additionally it plans, conducts, and promotes evaluation efforts that assist POTUS in assessing federal program objectives, performance, and efficiency. Finally, OMB also oversees and coordinates the Administration's procurement, financial management, information, and regulatory policies (for details on OMB, visit <http://www.whitehouse.gov/omb/>).

c. Under Secretary of Defense (Comptroller) (USD (C)). Within the OSD there is appointed an USD(C) who advises and assists the Secretary of Defense (SECDEF) in exercising budgetary and fiscal responsibilities. As such, the USD (C) supervises and directs the preparation of DOD budget estimates and establishes and supervises the execution of policies and procedures to be followed in connection with organizational and administrative matters relating to: preparation of budgets; fiscal, cost, operating, and capital property accounting; and progress and statistical reporting. Finally the USD(C) establishes and supervises the execution of policies and procedures relating to the expenditure and collection of funds administered by DOD and establishes uniform fiscal terminology, classifications and procedures used in the DOD's fiscal management. The USD (C) is the DOD Chief Financial Officer (CFO) (for details on the Office of the USD (C), visit <http://www.dtic.mil/comptroller/>).

d. Secretary of the Army (SECARMY). Subject to the authority, direction, and control of the SECDEF and subject to the provisions of section 3013 of Title 10, USC, the SECARMY is responsible for, and has the authority necessary to conduct all affairs of the Department of the Army (DA), including the following functions:

- (1) Recruiting
- (2) Organizing
- (3) Supplying
- (4) Equipping (including research and development)
- (5) Training
- (6) Servicing
- (7) Mobilizing
- (8) Demobilizing
- (9) Administering (including the morale and welfare of personnel)
- (10) Maintaining
- (11) The construction, outfitting, and repair of military equipment
- (12) The construction, maintenance, and repair of buildings, structures, and utilities and the acquisition of real property and interests in real property necessary to carry out the responsibilities specified
- (13) Further, subject to the authority, direction, and control of the SECDEF, the SECARMY is also responsible to the SECDEF for the following: the functioning and efficiency of the DA; the effective and timely implementation of policy, program, and budget decisions and instructions of POTUS or the SECDEF relating to functions of HQDA; and the performance of the functions of the HQDA so as to fulfill the current and future operational requirements of the unified Combatant Commands. As such the SECARMY can be considered the Army's top resource manager because of the position's inherent decision-making authority over the affairs of HQDA.

e. Assistant Secretary of the Army (Financial Management & Comptroller) (ASA (FM&C)). Within the OSA there is appointed an ASA (FM&C) who exercises the comptroller functions of the HQDA and advises the SECARMY on financial management as directed by 10 USC Sec. 3016 (see Fig 9-1 for the organization of the Office of the ASA (FM&C)).

(1) Military Deputy for Budget. The Military Deputy for Budget is responsible for the Department of the Army's budget execution. The Director for Army Budget reports directly to the Military Deputy for Budget.

(2) Director of the Army Budget (DAB). See Chapter 9, PPBE.

(3) Deputy Assistant Secretary of the Army (Financial Operations) (DASA (FO)). The DASA (FO) is responsible for: policies, procedures, programs, and systems pertaining to finance and accounting activities and operations; Army financial management systems and data integration activities; Army programs for management control, internal review and audit compliance, the Government Travel Charge Card, and fraud, waste and abuse; and other management evaluation activities. To accomplish its missions and functions, the Office of the DASA (FO) is organized into three directorates (Accountability

and Audit Readiness, Internal Review, and Finance and Accounting Oversight. Additionally, the U.S. Army Financial Management Command, a HQDA Field Operating Agency (FOA), is under the control of the DASA (FO).

## Assistant Secretary of the Army (Financial Management and Comptroller)

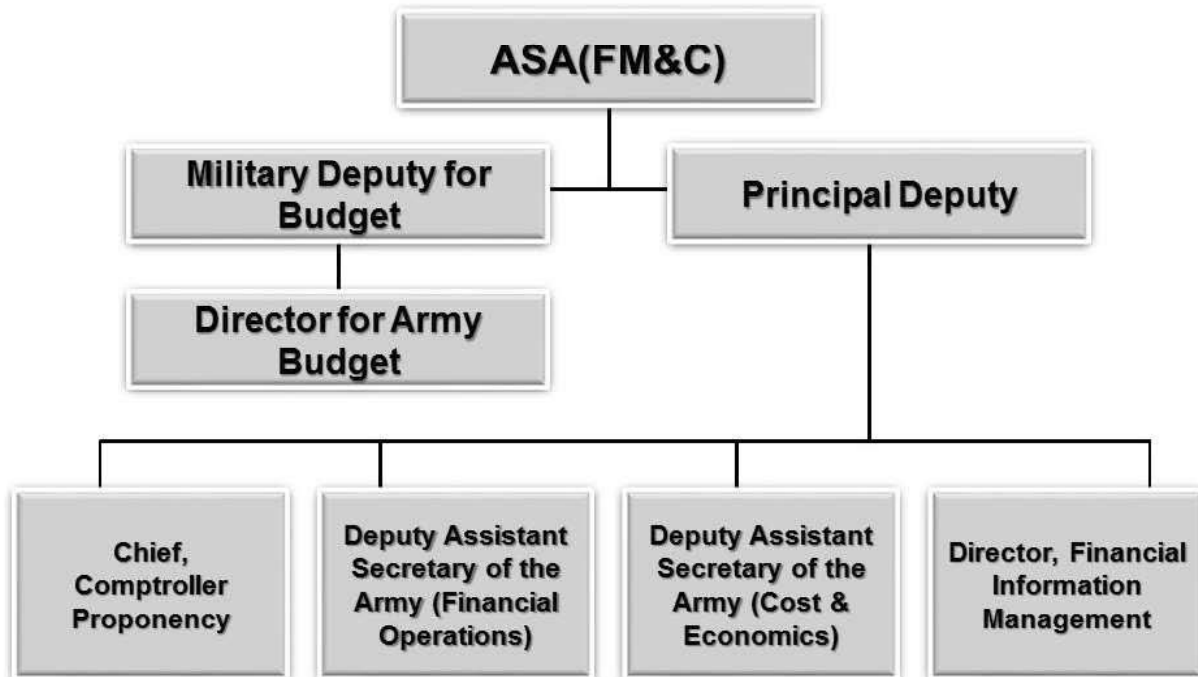

**Figure 9-1. Office of the Assistant Secretary of the Army (Financial Management and Comptroller)**

(4) Deputy Assistant Secretary of the Army for Cost and Economics (DASA (C&E)). The DASA (CE) is responsible for implementing the Army Cost and Economic Analysis Program through the development and promulgation of cost and economic analysis policy, cost estimating models, and cost databases for Army wide use. DASA (C&E) conducts component cost analysis for weapons and automated information systems (AIS) and manages the Army Cost Review Board and Army Cost Position. DASA (C&E) is responsible for conducting force structure, operations and support (Operations Tempo (OPTEMPO)), personnel, and installation cost analyses. Other functions include implementation of the Army Activity Based Costing / Management Strategic Plan, management of the Army Cost Research Program, and review and approval of CBAs.

(5) Director, Financial Information Management. The Director is responsible for advising, coordinating, and directing actions to achieve financial business transformation Army wide; capitalizing on on-going programs and projects; ensuring compatibility with and interoperability between Army financial systems and Defense systems; and incorporating advances in Army information technology, communications, and Government processes and systems. She serves the Army Financial Management community as Chief Architect and Chief Information Officer as well as the functional proponent for the General Fund Enterprise Business System (GFEBS) (for details on the Office of ASA (FM&C), visit <http://www.asafm.army.mil/>).

f. Commanders of Army Commands (ACOM) & heads of other operating agencies. Commanders of ACOMs and commanders and heads of operating agencies (e.g., Program Executive Offices (PEO), Program Managers (PM), and President, National Defense University) are responsible for developing,

justifying, presenting, and defending programs supporting their assigned missions and responsibilities. Further, they are accountable for ensuring approved program budgets are properly executed and certified. This responsibility includes ensuring accounting and fund status reporting for appropriated and non-appropriated funds is accomplished in accordance with fiscal law and governing regulations and policies.

### 9-3. A Framework to Help Study Resource Management

a. For the study of the internal workings of the Army's RM System and how it functions, it helps to use the "Four A's" model:

- (1) Acquire resources.
- (2) Allocate those resources according to the priorities generally considered in terms of dollars and manpower.
- (3) Account for those resources with a system that provides a decision support and tracking capability for the program and budget functions, and a system that performs accounting for fiscal compliance required by statutes.
- (4) Analyze the execution of those resources and implement course corrections as required.

b. These functions—acquire, allocate, account, analyze—are performed in a closed-loop process. Though it is recognized that there are other models that describe the elements of RM, for this discussion the "4-A's" model is sufficient.

## Section II Acquire Resources

### 9-4. Acquiring The Fiscal Resources For The Army

Described in detail in Chapter 9, the Army's Planning, Programming, Budgeting, and Execution (PPBE) process provides the means by which the Army justifies and acquires its resources from Congress. After authorization and appropriations acts are signed into law, several interrelated functions are performed by OMB, the U.S. Treasury, the Office of the Under Secretary of Defense (Comptroller) (OUSD (C)) and OASA (FM&C) to acquire the Army's financial resources and distribute them to the field for execution. Figure 9-3 graphically portrays this process.

a. Apportionment.

(1) An apportionment requires a specific request. Using SF 132, Apportionment and Reapportionment Schedule, the ASA (FM&C) Funds Control Officer (SAFM-BUC-E) prepares the request within 5 days of the availability of an appropriations act or in response to approved reprogramming requests, supplemental appropriations, or rescissions. OSD approves or revises the apportionment requests and submits them to the OMB for approval. OMB approves, changes, or disapproves the requests and returns apportionments through OSD to the Army for entry into GFEBS. OMB apportions the following:

- (a) Operating Accounts-Operation & Maintenance (O&M), Military Personnel (MILPERS), and Army Family Housing, Operations (AFHO)-on a fiscal quarterly basis
- (b) Investment accounts-RDT&E, Procurement, Military Construction (MILCON), and Army Family Housing (Construction) (AFHC))-at the start of the FY rather than on an incremental basis, funding the entire amount of the appropriation.

(2) The apportionment determines the Budget Authority (BA) available in GFEBS. For the operating accounts—even after releasing the entire program to the command—it is the cumulative amount of BA issued to commands and agencies by quarter that determines the execution level for the appropriation.

(3) Apportionment requests. Apportionment is a process for the administrative control of appropriations and funds. It is also a distribution of a specified amount of Obligation Authority (OA) in an appropriation / fund that is available for specified time periods (for example, fiscal quarter), activities, projects or a combination thereof as approved by the OMB. The amounts so apportioned limit the obligations that may be incurred by the Army. After Congress passes an appropriation bill and POTUS signs it into law, the OASA (FM&C) submits an apportionment of funds request through OUSD (C) to OMB. OMB reviews the request, adjusts the amounts as may be necessary based on their analysis of prior Army spending patterns, approves the request, and transmits the approved request back down through OUSD (C) to the OASA (FM&C). Within OASA (FM&C), the HQDA Funds Control Officer loads the approved apportioned amounts into the GFEBS. GFEBS is the official funds control management system of the DOD and is



used throughout the Army financial management community to control the fund distribution process (see Fig 9-2).

b. Program documents. In addition to the approved apportionment mentioned above, OUSD (C) may issue further restrictions on using the OA provided in the apportionment document by withholding amounts for specific programs. These restrictions come to HQDA via an OA letter (for Operations and Maintenance (O&M), Military Personnel (MILPERS), and Army Family Housing Operations (AFHO) appropriations), a DD Form 440 (for Procurement and Research, Development, Test, and Evaluation (RDT&E) appropriations), or a DD Form 460 (for the MILCON appropriations).

### 9-5. Treasury Warrants

After POTUS signs the appropriations bill(s), the U.S. Treasury issues appropriations warrants to establish bank accounts on the books of the U.S. Treasury for each appropriation. The Treasury Warrant is a financial controlling mechanism and gives the Army the authority to disburse funds (e.g., write a check to pay for an obligation) from those accounts. Without this authority, the Army cannot make any payments citing the non-warranted appropriation.

## Section III Allocate Resources to the Field

### 9-6. Fund Distribution and Control

Passing funds through command channels and making the commander responsible for their control is the basic tenet by which the Army's funding distribution system operates. In this case the use of the term "funds" implies that the authority to create obligations, for which the U.S. Government (USG) has to pay, has been granted. Distribution of funds is any documented action that makes funds available for obligation. This distribution is made in a stated amount for specific purposes and to a specific organization for a specific time period. The commander's authority to incur obligations is received on a funding document, which specifies the appropriation and budget program for which the funds may be used, and identifies applicable statutory limitations. This process is used to facilitate control over funds and the reporting of violations of laws and directives. Today, IMCOM centrally controls BASOPS funding.

a. The Distribution Procedure. After obtaining OA from OMB and OUSD (C), HQDA directs major commands and other subordinate operating agencies to execute their approved budgeted programs (see Fig 9-2). Using the GFEBS, the HQDA Funds Control Officer in the OASA (FM&C) allocates program authority and OA to ACOMs and operating agencies based upon guidance from the appropriation sponsors. ACOMs and operating agencies in turn sub-allocate or allot to the appropriate subordinate organization (for example, installation, major unit, PM, and so forth) where the program will actually be executed by obligating for such things as payroll, travel orders, contracts, purchase orders, and so forth. Although this funds distribution system is a means of controlling obligations and fixing responsibility, the policy is to minimize the formal distribution and to fund an operation at the highest practical level. As an example, the MPA appropriation is held and controlled centrally at HQDA, whereas the OMA appropriation is decentralized through the ACOMs to the installations.

b. Funding Guidance. Along with program authority and BA moved out to Army activities through the GFEBS, HQDA normally issues additional specific spending guidance at the beginning of the FY. The appropriation sponsors for OMA and AFHO issue annual funding letters to ACOMs with required or specialized fiscal guidance that is to be used in the execution of the budget for the FY. ACOMs and operating agencies may also issue specific funding guidance to their subordinate commanders and activities for the execution of their programs and budgets. The Chief of the Army Reserve (CAR) issues a funding guidance letter to subordinate U.S. Army Reserve (USAR) activities for executing the Operations and Maintenance, Army Reserve (OMAR) appropriation and the Reserve Personnel, Army (RPA) appropriation. Likewise, the Director of the Army National Guard (DARNG) issues a funding guidance letter to subordinate Army National Army Guard (ARNG) activities, principally the state adjutants general, for executing both the Operations and Maintenance, Army National Guard (OMNG) appropriation and the National Guard Personnel, Army (NGPA) appropriation.

## Funds Distribution Process



Figure 9-2. Fund Distribution Process

### 9-7. Fund Authorization Document

Using the **General Fund Enterprise Business Systems (GFEBS)**, the HQDA Funds Control Officer issues FADs to allocate OA and program authority to ACOMs and operating agencies. The ACOMs and operating agencies in turn use GFEBS to issue FADs to their subordinate activities (for example, installations) to allot OA and program authority. For the procurement and RDT&E appropriations, an approved program document accompanies the FAD to provide further administrative limitations on the use of those funds.

### 9-8. Fund Allowance System

Some ACOMs and operating agencies have implemented a fund allowance system whereby the lowest formal distribution of funds is at the ACOM / operating agency level with funding allowances being issued to subordinate installation commanders or activity heads. The advantages of this system are that it allows more flexibility in fund control and lessens the possibilities of reportable statutory violations. Commanders are still responsible for assuring the execution of their mission remains within the provided fund allowance and violations of that guidance may warrant administrative disciplinary action. Exceeding this funding allowance does not constitute a statutory violation but could cause an over-obligation or over-expenditure of the ACOM allotment provided on the Funding Authorization Document. Nevertheless, individuals responsible for exceeding their allowances will be named responsible for any resultant ADA violations.

**9-9. Delegation of Funding Authority**

Commanders to whom funds are made available may delegate authority to establish and maintain such administrative controls as may be necessary to comply with the provisions of federal fiscal law and Department financial management regulations. This may be done keeping these key points in mind:

- a. Delegation of authority must be in writing (verbal or telephonic authorizations will not be recognized except in emergency circumstances (e.g., those jeopardizing health and/or safety of the command) and must be confirmed in writing as soon as possible).
- b. Authority may be delegated to a named individual or a position as long as the authority is vested in a readily identifiable person at all times.
- c. Delegation of authority does not relieve commanders of their fiscal responsibilities under the law.

**9-10. Special Classified Programs**

Classified programs may be compartmentalized for security reasons. Specific funding distribution procedures have been created to accommodate the unique security requirements of such programs. Generally, the VCSA must approve the use of the procedures.

**9-11. Secretary of the Army Representation Funds**

Congress gives the SECARMY a specific level of authority to be used for emergency and extraordinary expenses from within the OMA appropriation. These authorities are identified under limitations entitled with the limit code .0012, described in AR 37-47, Representation Funds of the Secretary of the Army. The utilization of these authorities are very closely monitored and fall under audit responsibilities of the Army Audit Agency to ensure that funds used under these authorities are solely for the purposes intended and approved by the SECARMY. The rules for using the authorities are very specific and exceptions to deviate should be obtained from higher headquarters. A brief description of these authorities is provided below.

- a. Limitation .0012 (Miscellaneous Expenses, Category A). For official representation expenses, as authorized by the SECARMY, in connection with official functions at times of national holidays; dedication of facilities; visits of distinguished guests; purchase of floral wreaths, decorations, and awards upon occasions of national holidays and similar observances in foreign countries; and gifts and mementos by the authorized host, costing not more than \$200 each, used in connection with official ceremonies or functions. Commanders of ACOMs, their subordinate commanders, and installation commanders are authorized to present gifts or mementos in circumstances that they personally document as being a necessary part of the event or occasion being observed.
- b. Limitation .0014 (Miscellaneous Expenses, Category B). For miscellaneous expenses, other than for official representation, not provided for in other appropriations. Examples of these expenses are awards for emergency rescues, witness fees for the Armed Services Board of Contract Appeals, and settlement of meritorious claims.
- c. Limitation .0015 (Criminal Investigation Activities, AR 195-4). For emergency and extraordinary expenses in support of the worldwide expenses of the U.S. Army Criminal Investigation Command's activities.
- d. Limitation .0017 (Intelligence Contingency Funds, AR 381-141). For expenses related to worldwide intelligence activities.
- e. Limitation .0019 (Compartmented Special Operations, SECARMY Letter of Instruction (proponent HQDA, G-3/5/7). For emergency and extraordinary expenses related to worldwide-compartmented operations.

**Section IV****Account for the Use of Resources****9-12. Legally Using the Resources to Accomplish the Mission**

This section gives a brief overview of the controlling principles used in accounting for the use of fiscal resources. Title 31, USC, Section 1301(a) states that "Appropriations shall be applied only to the objects for which the appropriations were made except as otherwise provided by law." Congress initially enacted this statutory control in March 1809. The act, generally referred to as the Purpose Statute, was passed as a part of a reorganization of the War, Navy, and Treasury Departments to limit the discretion of the

executive branch in spending appropriations. To preclude the misappropriation/misspending of funds, a body of laws, regulations, court decisions, and rules has evolved over many years to direct how fiscal resources will be used to accomplish the Army's missions and tasks. Because Congress provides funds in specific amounts for specific purposes through the enactment of public law, the expenditure of those funds must be within the boundaries established by the law. The term "administrative control of funds," as required by law is used to identify those actions, events, or systems that are required to ensure essentially three things:

- a. Funds are used only for the purposes for which they were intended.
- b. Amounts of funds in excess of that available, are neither obligated, neither disbursed nor further distributed.
- c. The agency head is capable of fixing responsibility in the event of violations of either of the first two.

### 9-13. Availability of Appropriations for Obligations

Congress determines how long an appropriation or fund may be used, that is, new obligations may be made against the specified appropriation or fund. Most appropriations used by the Army have a limited time period for which new obligations can be made against them. Note: In the past Congress has made exceptions to the normal periods of availability of appropriations such as making two year or "X" year O&M appropriations, three-year RDT&E appropriations, as well as continuing with the normal periods of availability.

a. Annual Appropriations. These appropriations, generally having a one-year period of availability to be obligated, include:

- (1) Operation and maintenance appropriations like OMA, OMNG, OMAR, and AFHO.
- (2) Military personnel appropriations like MPA, NGPA, and RPA.

b. Multi-Year Appropriations. These appropriations having a multi-year period of availability include:

- (1) The RDT&E appropriation is available for two years.
- (2) Procurement appropriations (e.g., Aircraft Procurement, Army; Missile Procurement, Army; Procurement of Weapons and Tracked Combat Vehicles (WTCV), Army; Procurement of Ammunition, Army; and Other Procurement, Army (OPA)) are available for three years.

(3) MCA; MILCON, National Guard (MCNG); MILCON Army Reserve (MCAR); and Army Family Housing Construction (AFHC) are available for five years.

c. "No-year" Appropriations. These appropriations and funds have an unlimited period of availability. Examples include the appropriation for Base Realignment and Closure (BRAC) and the Army Working Capital Fund (AWCF).

d. Expired Appropriations. Once an appropriation's period of availability is over for incurring new obligations, it is considered "expired." For five years after an appropriation expires (i.e. no new obligations can be incurred) both obligated and un-obligated balances of that appropriation shall be available for adjusting and liquidating (that is, disbursing against a previously incurred obligation) obligations properly charged to the account. As an example, the FY 18 OMA appropriation has a period of availability for obligation from 1 October 2018 through 30 September 2019. The appropriation has a five-year expiration period from 1 October 2018 through 30 September 2022.

e. Cancelled Appropriations. After the fifth year of expiration an appropriation is canceled on the books of the U.S. Treasury. The appropriation is no longer available for any purpose, for example, accounting adjustments. Obligated and un-obligated balances are canceled. Using the FY 18 OMA example above, it would cancel on 30 September 2022. Note: If an obligation adjustment, such as a final settlement to a disputed contract, has to be made from what is now a canceled appropriation, then the payment is made out of the activity's current year appropriation subject to several limitations such as total amounts of such transactions cannot exceed 1% of the current appropriation and cannot exceed the un-liquidated balance of the initial, now cancelled, appropriation.

### 9-14. Properly Obligating the Resources

An obligation is the action taken to establish a liability against the USG that will ultimately result in a disbursement from the U.S. Treasury. There are several principles that must be followed in executing and accounting for obligations. The foundations for these principles are contained in Title 31 Money and Finance of the USC. While only the most important "obligating" principles are outlined here, the entire listing is provided in the DOD Financial Management Regulation 7000.14-R or in DFAS-IN Regulation 37-1 (Finance and Accounting Policy Implementation).

- a. Bona fide need of the current FY. A determination must be made that supplies or services required pursuant to contracts entered into or orders placed obligating an annual appropriation are intended to fill a bona fide need of the current FY. There are provisions when lead-time is an important factor to obligate funds in the current year for a subsequent year delivery.
- b. Intent of Performance. Contracts entered into or placed for supplies or services are executed only if there is a bona fide intent on the part of the contractor (or other performing activity) to commence work promptly or to perform the contract in accordance with its terms and conditions (to include beginning date).
- c. Assure Availability. The responsible official must ensure that proper funds are available before binding the USG in an agreement with a second party, which will result in an obligation for which the Government is required to pay.
- d. Documentary Evidence. Each obligation recorded in the official record must be supported by proper documentary evidence. These may be originals, duplicates, or copies of appropriate documents so long as signatures are visible. A memorandum of telephone conversation or an electronically received written message may be used temporarily until the actual document is received.
- e. Charge Immediately. Obligations, when incurred, must be charged immediately to the applicable account. The recording of obligations incurred cannot be deferred until additional funds are received. The obligation must be recorded even if there are insufficient funds to cover it, thereby incurring a statutory violation, which must then be reported through command channels. Failure to record an obligation will not obviate a suspected violation of the ADA statute.
- f. Prompt Adjustment. Any adjustment to previously recorded obligations, either as an increase or decrease, must be entered in the accounts as soon as the necessity for an adjustment is evident and the amount can be determined.

**9-15. Anti-Deficiency Act**

Chapters 13 and 15 of USC Title 31 contain prohibitions with respect to the legal use of funds and establish punitive provisions in the event there are violations. When the ADA was codified into the USC, its provisions were incorporated into a number of sections of Title 31. The sections that are most frequently cited are sections 1341, 1342, and 1517.

- a. How Anti-deficiency Act Violations Occur. Generally, ADA violations may occur when:
  - (1) Funding authority is issued in excess of the amount available and the excess amount is obligated or expended.
  - (2) There are violations of the special and recurring statutory limitations or restrictions on the amounts for which an appropriation or fund may be used.
  - (3) There are violations of statutory or regulatory limitations on the purposes for which an appropriation or fund may be used.
  - (4) Obligations are authorized or incurred in advance of funds being available.
  - (5) Obligations or expenditures of funds do not provide for a bona fide need of the period of availability of the fund or account and corrective funding is not available.
- b. Administrative and criminal penalties for ADA violations. The person who caused the violation may be subject to discipline, to include suspension without pay or removal from office (31 USC 1349 and 1518). The Army's implementation procedures of these statutes are contained in DFAS-IN Regulation 37-1 (Finance and Accounting Policy Implementation). If an action is taken knowingly and willfully and results in a conviction for violating the ADA, the person may be fined up to \$5000, imprisoned for not more than two years, or both (31 USC 1350 and 1519).

**9-16. Accounting for the Obligation**

- a. Legal Mandate to Account for Funds. By law the DOD is required to maintain accounting systems that provide:
  - (1) Complete disclosure of the financial results of the Department's activities.
  - (2) Adequate financial information the Department needs for management purposes.
  - (3) Effective control over, and accountability for, assets for which the Department is responsible.
  - (4) Reliable accounting results that will be the basis for:
    - (a) Preparing and supporting the Department's budget requests.
    - (b) Controlling the Department's budget execution.
    - (c) Providing financial information POTUS requires.

(d) Suitable integration of the Department's accounting with the central accounting and reporting responsibilities of the Secretary of the Treasury.

b. Defense Finance Accounting System (DFAS). As can be surmised, if the DOD is required to account for the ways it spends its funds, so too does the Army have to account in the same way for how it uses its funds. Most of the financial management accounting required by the Army is performed by DFAS. This organization was established in January 1991 to reduce the cost and improve the overall quality of DOD financial management through consolidation, standardization, and integration of finance and accounting operations, procedures, and systems. DFAS took over responsibility for five finance and accounting centers and 338 installation finance and accounting offices that belonged to the military services and Defense agencies. Through its mandated consolidation efforts, DFAS now consists of a headquarters located in Washington, D.C., five centralized sites located in Indianapolis (formerly the U.S. Army Finance and Accounting Center), Cleveland, Columbus, Denver, Kansas City, and 20 field sites or Operating Locations (OPLOCs). Personnel staffing levels were reduced from 31,000 in 1992 to the current level of 18,000. Since 1991 DFAS has consolidated and standardized 324 finance and accounting systems down to 109 systems in 1998. In the future DFAS expects to reduce down to 32 systems.

c. Accounting systems used by the Army. The Army and its subordinate activities use a number of the remaining accounting systems operated by DFAS. The principal system used is GFEBs. Other accounting systems are used by the Research, Development and Acquisition activities, the U.S. Army Corps of Engineers, and the Army National Guard.

### 9-17. The Army Management Structure

a. The AMS serves as a second major resource recording structure. Based on congressional appropriations, the AMS relates program dollars and manpower to a standard classification of activities and functions per DFAS-IN Manual 37-100-\*\*\*\* (where \*\*\*\* stands for the CY, e.g., 2018). AMSCO help record the data in the detail needed for budgeting, execution, and accounting.

b. The AMS provides a RM language and coding structure that is based on congressional appropriations. It relates program dollars and manpower to a standard classification of activities and functions required and used by Congress as they deliberate on Army programs and budget requests. GFEBs has initiated a term called functional area which combines the first six digits of the old AMS Codes (AMSCO) and the Management Decision Execution Package (MDEP) to help record data in the detail needed for budgeting, execution, and accounting. Army activities use the AMS to record obligations and disbursements in the requisite accounting system. The details for constructing the accounting and classification codes for all funds received by the Army are contained in DFAS-IN Manual 37-100-xx, where the "xx" indicates the last two digits of the FY. For instance the AMS for FY 2018 would be outlined in DFAS-IN Manual 37-100-18. Using the AMS coding structure assists Army activities to fulfill federal accounting requirements. A simple illustration translating an accounting classification code (e.g., purchase request, Temporary Duty (TDY) orders, etc.) would be the following accounting fund cite on a supply purchase transaction at Fort Sill: 21 2 2020 57-3106 325796.BD 26FB QSUP CA200 GRE12344019003 AB22 WORNA S34031.

### 9-18. Year-End Certification of Accounts

Since DFAS was established, the subordinate Defense Accounting Office (DAO) has had the responsibility for preparing and monitoring "accounting reports" at the installation. Commanders who receive FADs authorizing them to incur obligations not in excess of certain amounts and for specific purposes have a legal requirement to "certify the status" of those funds as of 30 September, that is, the end of FY. Commanders may delegate the authority to certify FY-end reports to the Deputy Commander, Chief of Staff, Garrison Commander, or Director of RM.

a. The DAO will make the certification on the "accounting reports" substantially as follows: "I hereby certify that the attached reports and associated schedules include all transactions received which have been properly recorded and are supported by subsidiary accounting records."

b. The DAO will forward the certification to the Commander or a designated representative, who, in turn, will make the following certification: "I hereby certify that the attached reports and schedules include all known transactions. Those meeting the criteria of 31 USC 1501(A) have been obligated and are so reported. All reports and schedules for all transactions for the fiscal year ended September 30, \_\_\_\_\_, are correct and are supported by subsidiary accounting records. All individual upward obligation and open

allotment disbursement adjustments in excess of \$100,000 of expired appropriations have been properly approved and are on file for audit purposes.”

c. Certifications are required for all appropriations and for any reimbursable activity performed by the command or agency. The ASA (FM&C) certifies all Army appropriations to the U.S. Treasury.

**Table 9-1. Translating an Accounting Code**

Code	Data Element Treasury Symbol:	Translation
21	Department Code	Department of the Army
8	Period Availability	FY 2018
2020	Basic Symbol	OMA Appropriation
57	Operating Agency	TRADOC
3106	Allotment Serial Number	(a locally assigned code)
325796.BD	AMSCO or Project Account	BASOPS (-), Director of Logistics
26FB	Element of Resource	Supplies - Army Managed / DWCF item
QSUP	MDEP	Installation Supply Operations
CA200	Functional Cost Account	Commercial Activities - contract furnished supplies
GRE1234019003	Standard Document Number	(a locally assigned code)
AB22	Account Processing Code	(a locally assigned code)
WORNAA	Unit Identification Code (UIC)	Fort Sill Garrison
S34030	Fiscal Station Number	DFAS OPLOC, Lawton, OK

**Section V**  
**Analyze the Use of Resources**

**9-19. A Change in Responsibilities**

The Chief of Staff, U.S. Army (CSA) charged Army leaders with the responsibility to evaluate or analyze and report on the effectiveness of program and budget accomplishment. These evaluations and reports relate funds and personnel inputs in output terms to the Army’s Title 10 responsibilities. In 2003 DOD, the MILDEPs, and agencies renamed their RM processes to the PPBE process.

**9-20. Execution Reviews**

Using the information presented by the accounting systems and other data feeder systems, functional, programmatic and fiscal managers along with commanders track the course of program and budget execution in their organization or functional area. Inherent in this analysis is the need to judge program performance and effectiveness, to consider the need for more resources to accomplish the specified program, and finally to consider reallocation of resources to higher priority missions and programs. This process takes place at all of the resourcing echelons of the Army.

**9-21. Headquarters, Department of the Army Quarterly Reviews**

The Army conducts quarterly reviews of program performance and fiscal execution focusing on strategic priorities and performance metrics. The OASA (FM&C) is responsible for the conduct of the quarterly reviews.

**9-22. Shifting Resources**

During the course of analyzing the execution of resources, there often arises the need to shift resources outside the boundaries of programs for which Congress authorized and appropriated funds. Examples of such real life events may be an emerging contingency operation, storm damage to an installation, increasing cost of installation utilities, accelerating the procurement of an item to achieve an economic savings, new bills resulting from a newly assigned mission, and so forth. The congressional committees concerned with DOD’s operations have generally accepted the view that rigid adherence to the amounts

justified for budget activities, appropriations, or for subsidiary items or purposes may unduly jeopardize the effective accomplishment of planned programs in a businesslike and economical manner.

a. Reprogramming procedures have been worked out with the congressional committees (House and Senate Appropriations and Authorization Committees (and for intelligence related items, the House and Senate Select Intelligence Committees)) to accommodate different degrees of interest in the reprogramming of funds; that is, certain reprogramming requires prior approval by the appropriate committees of Congress, while others require advance notification, and still others are provided notice after the fact. Reprogramming reapplies funds from one project to another within the same appropriation or transfers funds from one appropriation to another to resolve financial shortfalls or to adjust programs to meet unforeseen requirements. The process is subject to designated dollar thresholds and congressional requirements for advance approval or notification. No transfers (shifts between appropriations) are allowed without prior consent of Congress and must be requested in writing by the submission of the Congressional Reprogramming Request (DD 1415).

b. Other flexibility is obtained through additional laws, committee reports, or by requesting supplemental appropriations. The OASA (FM&C) manages the reprogramming process for Army appropriations.

### **9-23. Analyzing the “Accounting Books”—Joint Reconciliation Program**

The Joint Reconciliation Program is an effort combining the skills and expertise of accountants, budget and program analysts, contracting professionals, logisticians, internal review auditors, and DFAS personnel for the purpose of verifying the validity of un-liquidated obligations, contractor work in progress, billing status, and validating the continued need for goods and services that have not yet been delivered. The reconciliation must be performed by all commands and, when performed properly, will result in real dollar savings through the identification and cancellation of nonessential goods and services, reconciliation of current appropriations to ensure the correctness of amounts obligated, and liquidation of appropriations expiring at the end of the FY.

a. The primary objectives of the Joint Reconciliation Program are to “harvest” OA by:

- (1) De-obligating funds supporting invalid obligations.
- (2) Eliminating the use of current funds to pay liabilities arising from appropriations that expired.
- (3) Reconciling and liquidating delinquent travel advances.
- (4) Eliminating and avoiding Unmatched Disbursements (UMD).
- (5) Eliminating and avoiding Negative Un-Liquidated Obligations (NULO).

b. As a result of performing effective joint reconciliation, commands increase their purchasing power which directly enhances mission accomplishment. Purchasing power is increased in that:

- (1) Canceled account liabilities are reduced.
- (2) Current OA is harvested for reutilization.
- (3) Erroneous payments and over payments are identified and eliminated.
- (4) Visibility over contractor Work-in-Process (WIP) and Contract-in-Process (CIP) is increased.
- (5) Delinquent travel advances are eliminated.

c. Additionally, joint reconciliation increases the Army’s stewardship credibility with Congress. The integrity and accuracy of financial records has improved and the cycle time for processing financial transactions has been reduced. History has proven that using a thorough and intense joint reconciliation program is an excellent investment of time and resources and adds value to financial management, logistics, and procurement activities.

## **Section VI Improving Management and Business Practices in the Army**

### **9-24. Efforts to Improve Army Management**

Since the early 1980s, major legislative and Army management initiatives have introduced an unprecedented focus on performance and results. These initiatives all point to the transition to more outcome-oriented program management and performance budgeting.

### **9-25. Federal Manager’s Financial Integrity Act of 1982**

a. The FMFIA requires all federal agencies to establish and maintain effective accounting and administrative controls to provide “reasonable assurance” that:



- (1) Obligations and costs are in compliance with applicable laws.
  - (2) Funds, property, and other assets are safeguarded against waste, loss, unauthorized use or misappropriation.
  - (3) Revenues and expenditures are properly recorded and accounted for.
- b. The Act also requires agency heads to submit an annual statement to POTUS and the Congress indicating whether agency management controls are reasonable and, where they are not, material weaknesses are identified and corrective actions are taken.

**9-26. Chief Financial Officer Act of 1990**

- a. The CFO Act was enacted to implement more effective financial management practices in the federal government. Its key purpose is to provide more accurate, timely, and reliable financial information for decision-makers through improved accounting systems, integrated functional and financial management, and strengthened internal controls. The law also establishes initial requirements for the “systematic measurement of performance” by shifting the management focus from resource acquisition to resource execution—not in terms of obligation and outlay rates, but in how well taxpayer dollars are spent.
- b. A major provision of the Act mandated the preparation of audited annual financial statements for revolving funds, trust funds, and substantially commercial activities. The law designated ten federal agencies—including HQDA—as pilots for comprehensive, agency-wide financial statements covering all operations and activities. As the first DOD pilot under the CFO Act, the Army broke new ground in a number of important areas—for example, physical inventory policy, valuation of assets, interface between military pay and personnel systems, the incorporation of outcome-oriented program performance measures in financial reports, and the restructuring of the management control process. The U. S. Government Accountability Office (GAO) and congressional committees have acknowledged Army efforts and improvements. However, the Army cannot by itself achieve full compliance with the standards of the CFO Act. The resolution of long-term problems with financial systems is a DOD-wide effort and there must be government-wide accounting principles and standards to support both management decision-making and public accountability.

**9-27. Government Management Reform Act of 1994**

- a. GMRA implements the requirements for audited annual financial statements “covering all accounts and associated activities of each office, bureau, and activity of the agency” for all federal agencies. Beginning in 1998, and annually thereafter, the Secretary of the Treasury, in coordination with the Director of the OMB, is required to submit to POTUS and Congress government-wide audited financial statements that cover all accounts and associated activities of the executive branch of the federal government. With the end of the CFO Act pilot project and full implementation of reporting under the Act, the Army continues working to implement the letter and the spirit of the legislation and to improve all aspects of Army financial management and stewardship.
- b. The most recent financial report for the USG can be viewed online at <http://www.gao.gov/financial.html>
- c. The most recent financial statement for the Army can be viewed online at <http://comptroller.defense.gov/cfs/index.html>

**9-28. Government Performance and Results Act of 1993**

- a. The GPRA is major management reform legislation and a critical step in the inevitable transition to more outcome-oriented program management and performance budgeting. As noted above, the CFO Act intended to integrate financial and functional systems to provide better information for decision makers and shift management focus to how well taxpayer dollars are spent. Although implementation of the CFO Act and audited financial statements have led to significant improvements in financial reporting, the law itself provided only limited guidance with regard to its provisions for “the systematic measurement of performance”.
- b. The GPRA builds on the CFO Act and establishes the framework for full integration of financial and functional data in all phases of the resourcing cycle. GPRA was implemented to improve government-wide programs by linking resource expenditures to results achieved. OSD has implemented GPRA by establishing corporate and annual performance goals, and linking specific performance measures to each goal. The most recently completed Quadrennial Defense Review (QDR) serves as DOD's strategic plan in accordance with the GPRA requirements.

c. The purpose of the GPRA is to increase public confidence in the federal government and improve program effectiveness and public accountability by systematically holding agencies accountable for achieving program results. The law also is intended to improve congressional decision-making by providing more objective information on the relative effectiveness and efficiency of federal programs and spending. The AFR contains the Management's Discussion and Analysis section that provides executive-level information on the Department's history, mission, organization, key performance activities, analysis of the financial statements, controls and legal compliance and other challenges facing the Department. The APR will be included in the Congressional Budget Justification and provides the detailed performance information and description of results by performance measures. The Summary of Performance and Financial Information, formerly the DOD Citizen's Report, summarizes the Department's financial and performance information from the AFR and the APR, making the information more transparent and accessible to Congress, the public, and other key constituents. All three reports are available at the DOD Comptroller's website: <http://comptroller.defense.gov/reports.html>.

d. Through its PPBE process, the Army reviews and monitors its strategic plans and mission objectives. The PPBE process supports the Army's implementation of the GPRA by using The Army Plan (see Chapter 2, Strategy).

### **9-29. Federal Financial Management Improvement Act of 1996**

This law builds upon and compliments the acts discussed above. It requires auditors to report as part of their report on agencies' annual financial statements whether the agencies' financial management systems comply substantially with requirements. These three requirements are critical for ensuring that agency financial management activities are consistently and accurately recorded, and timely and uniformly reported throughout the federal government:

- a. Federal financial management systems requirements;
- b. Applicable federal accounting standards; and
- c. The USG Standard General Ledger at the transaction level.

### **9-30. Management Controls**

a. Management controls are the procedures established to ensure accomplishment of objectives and guard Army resources against fraud, waste, and abuse. Numerous audit and inspection reports, however, continue to find serious management control deficiencies in DOD and the Army. This damages the Army's reputation as stewards of public resources and hinders its ability to compete effectively in Congress for additional resources. Congress has made clear that their emphasis on management controls will continue.

b. Army Regulation 11-2, Management Control, establishes policies and guidelines for implementing the provisions of the Federal Financial Management Improvement Act. It describes the Army's current management control process which was restructured effective in FY 95 to reduce the administrative burden, to provide commanders and managers with greater flexibility in scheduling and conducting their evaluations, and to make them directly accountable for the effectiveness of their management controls. The restructured process requires management control evaluations only for the most critical controls (the "key management controls") and encourages commanders and managers to use existing review and oversight processes wherever possible to accomplish evaluations.

### **9-31. Improving Business Practices**

a. An essential element of RM is the process of reviewing, revising and reengineering the business practices of the Army to increase revenues, reduce costs, and leverage Army assets. Several tools have been developed to assist in furthering business practices improvements:

(1) The Business Practices Initiatives focus on Army operations to avoid or reduce costs, generate and collect revenues, leverage assets, streamline and consolidate functions, form partnerships, and use the latest technology to help the Army better utilize scarce resources.

(2) The development of initiatives under the focused leadership of the BSIT Forum is intended to support transformation of the business sides of the Department of the Army, resulting in a more efficient and effective business environment from which the total Army is supported.

(3) The Legislative Program expedites processing of viable, high payoff, reengineering legislative proposals through OSD, OMB, and Congress.

(4) The Non-Appropriated Fund (NAF) Financial Oversight prepares policy guidance and conducts reviews of NAF finances and encourages NAF activities to operate more like a business.

(5) The Waiver Program facilitates preparation, coordination, and submission of waiver requests to gain exceptions to certain policies or regulations on a case-by-case basis to improve processes.

b. The Army is implementing new and improved business practices to bridge the gap between Army resources and Army requirements. Many private sector business practices “make sense” for the DOD and can potentially be applied to optimize the use of Army resources. The overall objective is to stretch available resources by generating revenues, reducing costs, leveraging assets, and improving the delivery of service.

c. A major example of the successful use of business practices to bridge the gap between Army resources and requirements is in the area of real property assets (land and facilities). Historically, the Army relied primarily upon APFs (MILCON Funds) to build, modify, and upgrade Army facilities. The Army also relied upon APFs (Operating Funds) to maintain and repair the real property assets. The lack of sufficient funds allows construction of only the most critical facilities and causes a backlog of maintenance and repair that ultimately reduces the useful life of Army assets. As the size of the Army was reduced during the 1990’s, the Army began to dispose of real property assets that were underutilized and no longer needed. There is a significant cost associated with maintaining assets, even when the assets are maintained at a minimal level. This disposal effort is continuing. However, a problem surfaces when facilities are needed, but there are insufficient APFs to construct, modify, or maintain them.

d. To address this problem, the Army began using a new private sector tool – Public Private Ventures (PPV). PPVs can take many forms - the Residential Communities Initiative (RCI) Program; Armament Retooling and Manufacturing Support Program (ARMS); leasing initiatives that use Title 10, Section 2267 authority; Morale, Welfare, and Recreation (MWR) Program initiatives; utilities privatization; and energy saving projects. PPVs are unique because they involve a significant contribution of private capital and expertise to meet Army resource needs and the private sector requirements for successful business ventures must also be met. With the PPV approach, the Army is not buying a specified product in the traditional sense. The Army is selecting a private sector “partner” to work jointly on a solution that will line up both with Army requirements and those for commercial success.

e. The past several years have witnessed a quantum leap forward in the planned use of PPVs as a tool to bridge the gap between Army resources and requirements for real property assets. The Congress has repeatedly shown its general support for using this tool by passing very significant enabling legislation in areas such as housing privatization, utilities privatization, energy savings, and enhanced lease authority. These PPV efforts will have a prominent role in the way the Army manages its real property assets in the future and the Army will succeed if PPVs are part of a sound strategic plan; the Army adequately weighs the long-term implications of actions; and the Army realizes that PPVs make new and different demands on program and financial managers.

f. The Army is also wrestling with similar RM issues for activities supported by NAF. Base closures, troop realignments, and declining APF support create a challenging environment for NAF. Policy decisions for NAF must take into account a RM strategy that considers the interrelationship between APFs and NAF. Coordination between the NAF and APF communities is essential to ensure appropriate execution of both the appropriated and NAF programs. For example, a facility built as a NAF major construction project may be authorized APFs for maintenance and repair support. In such instances, a one-time NAF expenditure could result in a significant and continuing APF operating expense. Conversely, reduction of APF support for NAF activities can force dramatic changes in the level of quality-of-life programs available to Soldiers and their families.

g. Enabling and encouraging improved operating efficiency, better use of information, implementation of private sector practices, and enhanced utilization of Army resources through asset leveraging is essential to maximizing the use of The Army’s scarce resources. Improving business and operating practices is not only complementary to financial reform, but is in the spirit of reinventing government and the “battle on bureaucracy,” and is absolutely necessary to fully support Army transformation to meet future challenges.

### 9-32. Cost Management

a. CM must play a critical role in support of decision-making in order to maintain the maximum number of well-trained and properly equipped forces possible. CM allows the Army to maintain the maximum capability possible in the face of the constant reduction of dollars available to resource the force. This is an unfamiliar war, fought on an unfamiliar battleground by commanders and leaders generally new to the

weapons needed to win. CM, focused on the activities necessary to produce the products or services required for mission success, is the most important war-fighting doctrine available for employment. Given full understanding of the potential of CM and complete knowledge and use of its working parts, the cost war can be won.

b. The Army has chosen to implement Activity Based Costing (ABC) as a tool to assist the local manager in maximizing scarce resources and as a means of continuous process improvement. The Army Implementation Plan mandates CM / ABC implementation in the Army's eleven support business areas. These business areas are Acquisition, BASOPS, Civilian Human Resources (CHR), Contracting, Depot Maintenance, Information Support, Institutional Training, Ordnance, R&D Laboratories, Supply Management, and Test & Evaluation.

c. CM principles offer commanders greater flexibility in mission execution by providing more information in the decision-making process. Planning and the ABC model provide the foundation for CM. Use of the model in the commitment and review cycle enables commanders and other senior leaders to conserve resources within individual operations. By reducing the costs of individual operations, the manager has flexibility with funds during the execution year. These available funds must be identified early in the FY to enable execution of other priority missions. CM / ABC provides a mechanism for accomplishing the mission within the funds provided.

d. Army Cost Management Steering Group (CMSG). The CMSG is the Army's governance body charged with informing and influencing the implementation of cost management policy, strategy, key capabilities, and best practices that align and enable Army Leadership priorities. Army-wide support is needed to successfully implement cost management and meet the various information needs across department (see USA Memo, "Establishment of the Army Cost Management Steering Group, dtd 22 Oct 2014 @ [https://cpp.army.mil/portal/page/portal/Cost\\_Performance\\_Portal/ CPP\\_Main\\_Page/Cost%20Management/CM\\_Steering\\_Group>About\\_CMSG](https://cpp.army.mil/portal/page/portal/Cost_Performance_Portal/ CPP_Main_Page/Cost%20Management/CM_Steering_Group>About_CMSG)).

### 9-33. Cost Modeling

CM / ABC focuses managerial skills and action at all levels on the results of a cost modeling process that presents useful, accurate cost data based on the activity (a product or service) that the manager wishes to accomplish. Traditional cost accounting systems and processes in DOD do not provide the same focus. Instead, they focus cost models on bags of money that are available to accomplish grossly defined categories of expenditures. Amounts of money are allocated to the bag by passing down a limit or budget, then managers at all levels use up the money until someone tells them that the budget is exhausted. This is and has been the conventional way of operating. In fact, using up the entire budget allocated down to low levels in the organization has generally been viewed as a good thing. The budget has come to be thought of as an entitlement to spend. This is far from a desirable way to operate at a functional level. The objective should be to use as little money as possible to achieve a defined level of quality and thereby have as much money as possible available to allocate to other command priorities. These available funds must be identified early in the FY to enable execution of other priority missions.

### 9-34. Planning

a. Managers at all levels should accurately plan their future resourcing needs just as tactical commanders plan combat engagements in order to win the next battle and the overall campaign. Relative CM/ABC success should be measured based on how much and how often that manager can reduce the resourcing need over time while accomplishing the required tasks to an acceptable level of quality. Resources saved in the production of one product or service are then available to commanders to redirect to high priority tasks otherwise destined to be unfunded. The CM / ABC process, focused on important activities, in conjunction with other leadership tools, provides the manager the information needed to know how much something needed really costs and provides a structure to do something about the unit cost of producing it.

b. Integration of CM / ABC practices into the twenty-first century Army is designed to enhance decision making at all levels. This requires a cultural change within the Army, recognizing that CM/ABC is a necessary discipline for all managers and decision makers both military and civilian. Effective CM/ABC practices will assist us in understanding the true costs of producing goods and services, improving operations, and linking execution to Army strategies. CM / ABC fully supports continuous improvement to achieve the most efficient organization. Therefore it is useful in streamlining cost competition (competitive

sourcing), productivity and performance programs, and perhaps most of all, decision making by local managers. Executing CM / ABC doctrine controls costs and improves efficiency and effectiveness.

c. The support business areas will continue to be vital to the mission of the Army. CM / ABC is the Army's tool to maximize the effectiveness of existing fiscal resources. Aggressive, proactive management of existing resources is the best way to provide resources for higher priority mission needs such as improved mission support services, quality of life, and force retention.

d. Successful implementation of CM / ABC combines strong leadership support, a cycle of commitment and performance review, employee empowerment, and motivational incentives. With Army leadership serving as strong advocates, the CM / ABC culture establishes goals and encourages participative behavior to achieve improved performance.

### 9-35. Building an Activity Based Costing Model

a. An ABC model is needed because the traditional cost accounting system used by the DOD does not allow the assignment of all relevant costs to a product or service (activity). For example, a commander should know the total cost of activities under his control (e.g. the cost of overhauling a tactical vehicle, or training a Soldier in a new Military Occupational Specialty (MOS), or renovating a set of family quarters). More importantly, the manager that has the power to influence costs must know and understand them. By analyzing them and the process that produces them, the effective manager is prompted to discover numerous changes that will affect costs. The manager should expect subordinates to understand, explain, and improve cost performance. Unfortunately, a process of collecting and allocating costs that contribute to the creation of a product or service is not readily available. An ABC model needs to be built based on the real way the production mechanism functions in each business area and location. Building a specific model is a time consuming but necessary function to be able to deal with real data vice a template model, provided by others, that can produce only theoretical or standard costs. The creation and regular updating of a specific model is often viewed as too much work and therefore not attempted. The loser is the manager faced with more requirements than assets to get them done.

b. A process to build a model has to be used to capture and allocate costs. A useful model is built by allowing the people who do the work to build their model using a simple question and answer walk-through of what they do each day in performing their mission. All relevant costs are then allocated to the product or service that the tasks produce. No salary or other relevant expense can be left out. Managerial tasks commonly referred to as overhead and other costs have to be considered. On the other hand, precision, carried to an extreme, can overly complicate the process and diminish usefulness of the results. This outcome has been observed in many initial attempts at creating a useful cost model. Together, CM and the ABC model give the manager a structure to be as cost effective as possible.

c. A concrete example of the CM / ABC process at work: During the FY's first quarter CM performance review, the first-line manager in the vehicle maintenance shop presented the second quarter spending plan. During previous reviews under similar circumstances, the manager stated that his organization would need many hours of overtime in the second quarter to immediately repair vehicles returning from an extended deployment. For this review, because of an understanding and use of cost management and the cost model that represents their business process, the manager has become conscious of all costs and consistently tries to reduce them. The culture of the workforce has been changed to include reduced cost into the definition of mission success. To that end, additional time and effort can be spent better allocating work throughout the workforce and managing the second quarter's employee leaves more carefully. The manager also gave priority to repair only the vehicles that commanders deemed most critical to have repaired right away. This extra effort resulted in no overtime being required in the second quarter which can now be briefed as a unit cost for vehicle repair that was below the planned level. This identified alternative process, discussed in the performance review, will be recognized for possible wider application throughout the organization.

### 9-36. Using the Activity Based Costing Model

a. Once a model is built and is repetitively presenting unit cost results, a managerial process to use the data has to be implemented. Leaders with power to change the way things function must view the unit cost data, be presented with managers' analyses, and approve or create new work processes and direct their implementation.

b. A regularly scheduled performance review and planning meeting can be the single vehicle to do all these things. The manager is presented with the data, preferably by the individuals responsible for

spending the money to produce the product, and its correctness is evaluated. The best results are usually reached if the first line manager is the person explaining what the costs are and why his planned resource needs were either exceeded or improved upon. Since the overall goal is to reduce unit costs without sacrificing performance, that discussion ensues. It is important to remember that this same manager previously presented his spending plan, using his ABC model as the basis, for the quarter that is now being reviewed.

c. The commander or senior manager should be the leader at the review as this is the person who has the ultimate authority to implement procedural changes that result in cost reductions in the process under scrutiny. The commander is also the one that will reallocate the savings produced to higher priorities. An integral part of the overall methodology must be to provide incentives for managers at all levels to think and work smarter.

d. In the previous example, the commander may choose to divide the money now available for reallocation between the desire to pay for another need and to provide a reward to the manager that is helping win the cost war. The commander might ask the first line manager and the next level supervisor what is needed to improve the function of the organization that produced this improvement. The commander could choose to buy that new forklift for Supply that they have needed for a while but have not had the funds to buy. All this can happen at the same performance review thereby reducing the number of subsequent meetings that need to take place.

e. Commanders focus on the tactical component of CM / ABC by managing cost and performance throughout the cycle of planning and review to achieve continuous improvement. Leadership sets efficiency challenges to be achieved through the managing of activities (CM / ABC), processes, and cost. Gaining a better understanding of cost and performance will better enable managers to achieve the strategic goals set by Army leadership.

### **9-37 Cost Commitment and Review**

a. The cycle of commitment and review is the key for each business area to practice CM / ABC successfully. This process has been established through prototypes and is depicted in Figure 9-3.

b. Managerial costing requires commanders and senior managers to provide the leadership support and need for CM / ABC information. The necessity to pull or lead the cost reconnaissance process creates an atmosphere of cost awareness throughout the command. A cycle of forecasting and after-action review provides frequent feedback and accountability that drives continuous improvement and allows for the most efficient use of resources.

c. A good way to look at the cycle of commitment and review of cost managing in the future is by analogy to Command, Control, Communications, Intelligence (C3I) used in the tactical Army. The same principles can be applied to inform decision-makers in ways that lead to improved execution. This can easily fit the emerging requirements of better cost management.

d. ABC represents the intelligence or information gathering process. In battlefield management, these are the intelligence technologies that acquire information for war fighters. Cost warrior pull recognizes the war fighter as the customer of the management information system. The cost warrior will command what needs to be measured and how to present the information. Cost forecasting recognizes the value and importance of projecting the current cost situation into the future in order to control future spending. In financial terms this means that the cost control system should facilitate forecasting, what if analysis, and simulation. After-action cost review completes the cycle by considering actual mission execution and communicating the results. In financial terms, this means that cost warriors must ultimately be measured and held accountable for cost performance. The trend of cost based performance metrics should be expected to show continuous improvement.

e. Effective development of CM / ABC should provide an important weapon for winning the cost war. Strategies, tactics, and weapons that improve the command, control, and communication of cost will be important.

## Cycle of Commitment and Review

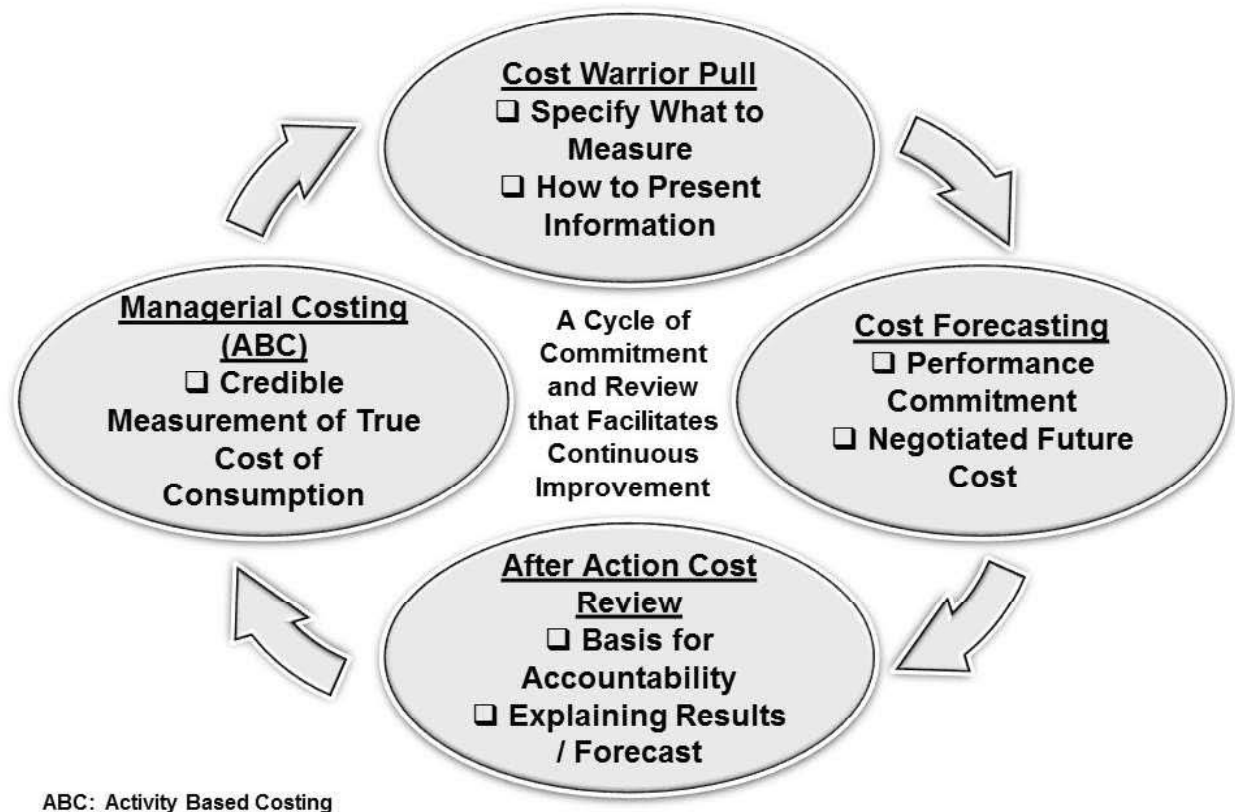

Figure 9-3. Cycle of Commitment and Review

### 9-38. Enterprise Resource Planning

The OSD-level Enterprise Funds Distribution (EFD) system is a web-based system which combines congressional tracking with funds distribution to the Army and contains specific instructions on funds control. EFD has standardized funding authorization documents (e.g., Obligation Authority (OA) letters, DD440 documents, DD460 documents and annual operating budget for Working Capital Funds appropriated funding).

### 9-39. General Fund Enterprise Business System

a. The GFEBS is a Chief Financial Officers Council certified commercial off the shelf (COTS) Enterprise Resource Planning (ERP) system designed to provide the Army and the Department of Defense relevant, reliable, and timely financial information across the full spectrum of its operations. GFEBS is helping the Army standardize and streamline its financial business processes to provide continuous access to financial information, as well as contribute an important element in the development of an Army integrated enterprise-wide system.

b. The three Army ERP systems—GFEBS, the Logistics Modernization Program, and the Global Combat Support System-Army—provide the Army an integrated enterprise-wide system to provide decision-makers with data for better informed decision making and to comply with legal and mandatory reporting requirements. As “mixed systems,” these three systems perform financial management functions to better support their primary missions and system functions.

c. GFEBS replaces existing information systems: the Standard Army Finance System; the Defense Joint Accounting System; and the Standard Operation and Maintenance Army Research and Development System. GFEBS is a web-based system designed to integrate seamlessly into the Army’s

current information technology environment. The project also includes significant business process reengineering, change management, and business case analysis support components. The GFEBS solution includes Design, Build, Run, and Application Service Provider services for approximately 10 years. Ultimately, GFEBS will replace over 80 Army legacy accounting, financial and asset management systems.

d. GFEBS processes financial, real property, cost management, and performance data, and then integrates this data for decision support. GFEBS' primary objectives include improving performance; standardizing financial and business processes; ensuring capabilities exist to meet future needs; and complying with statutory and regulatory accounting requirements. Specifically, GFEBS' goals are to: provide decision support information to sustain Army capabilities; provide analytic data and tools to support Institutional Adaptation; reduce the cost of business operations; and improve accountability and stewardship.

e. GFEBS is one of the largest ERP systems in the world, processing 1 million transactions a day for the active Army, ARNG, and USAR from some 79,000 end users at more than 200 sites worldwide. The system standardizes transactional input and business processes across the Army; provides accurate, reliable, online and real-time data; enables cost management activities; and ties budgets to execution. For the first time, the Army will have a single source for financial and related non-financial data, and a single system of record for the General Fund. GFEBS will enable the Army's workforce to focus its efforts on value-added tasks, such as analysis and decision making, as opposed to redundant data entry or extensive reconciliations, and empower leaders at all levels to determine the true costs of operations and the costs that affect their budgets. GFEBS is a complex initiative that blends expertise from many Army and Defense organizations in developing new enterprise business processes (for more information, visit <http://www.gfebs.army.mil/pmo/>).

f. GFEBS complies with the Standard Financial Information Structure standard, which is the common business language that supports information and data requirements for budgeting, financial accounting, cost/performance management, and external reporting across the DOD enterprise (for additional SFIS information, visit <http://www.defenselink.mil/bta/products/sfis.html>).

g. GFEBS Business Process Areas. GFEBS development activities are organized into six functional business process areas related to Funds Management.

(1) Funds Management (Budget Execution and Budget Formulation) – includes General Fund management, budget execution, and budget formulation below HQDA level.

(2) Property, Plant and Equipment – includes real property management and maintenance, materials management, equipment and asset management, and environmental liabilities.

(3) Spending Chain – includes initiating purchase requisition, checking funds, recording obligations, managing goods and services receipts, and logistics integration and inventory management.

(4) Cost Management – includes full costing, and payroll and travel interfaces.

(5) Financials – includes U.S. Standard General Ledger accounting (USSGL), workflow journal voucher approval process, financial statements, and month end and year-end closing processes. Also includes sub-processes of reimbursable management and accounting.

(6) Reimbursables – includes reimbursable order processing and debt management.

h. GFEBS Component Overview. GFEBS is based on the SAP ERP package, which includes software that supports a variety of process areas.

i. GFEBS Enterprise Resource Planning Central Component. The ERP Central Component (ECC) module processes transactions in real time and acts as the financial core of the system.

j. GFEBS Business Intelligence Module. The Business Intelligence (BI) module is the GFEBS data warehouse; it is updated several times a day from the ECC transactional data. BI is engineered for quick retrieval of data sorted in any number of ways and data is organized into easily-understood, user generated reports.

k. SAP Components, GFEBS uses eight SAP components to support eight Army business process areas: Funds Management; Financials (includes Special Purpose Ledger); Controlling; Spending Chain; Fixed Assets; Real Estate; Materials Management; and Business Intelligence (Key BI application is Integrated Planning, which provides the Budget Formulation and Spending Plan Management capabilities, in addition to the Reports and Queries capability).

l. Funds Management Business Process Change Summary. Table 9-2 provides a summary of the changes from the legacy state to the GFEBS state in the funds management business process area.



**Table 9-2. Funds Management Business Process Change Summary**

Without GFEBS	With GFEBS	Impacts
Funds distribution and funds execution performed in different systems with numerous complex interfaces and manual processes needed to manage across them.	Funds distribution within the same system as funds execution.	Visibility and control of funds not available in current system.
Limited ability to grant funds management authority to lower levels.	Budget planning within the same system as distribution and funds execution.  Perform commitment accounting.	Eliminate the need for centralized funds control or central order control points.  Impact of spending actions seen immediately in budget and financial reports.

**9-39. Cost-Benefit Analysis—A Key Decision-Making Tool**

a. Cost-Benefit Analysis (CBA) is a structured methodology for forecasting and comparing the anticipated costs and benefits of alternative courses of action in order to identify the optimum solution for achieving a stated goal or objective. The goal is to produce a strong value proposition--a clear statement that the benefits more than justify the costs, risks, and bill payers. See Figure 9-4.

b. In today’s resource-constrained environment, the Army must exercise wise stewardship of every dollar it manages. A key element in that stewardship is to develop and use sound CBA practices throughout all requirements / resourcing processes. For every proposed program, initiative, or decision point that is presented to decision makers, it is important to provide an accurate and complete picture of both the costs to be incurred and the benefits to be derived.

c. On March 14, 2011, the SECARMY published a Memorandum entitled, “Consideration of Costs in Army Decision-Making. In that memorandum, he reiterated the guidance given in the USA / VCSA Memo of 2009, as well as directing that “All issues, proposals, or requirements must address the costs and trade-offs against projected benefits.” The SECDEF identified the ASA (FM&C) as “proponent for costs in Army decision-making, policy, and guidance.”

d. ASA (FM&C) established the CBA Portal on the Cost and Performance Portal (CPP) to provide information on a wide range of requirements, issues, tasks, and problems that require a deliberate analysis to arrive at the optimum course of action (for both memorandums, visit [https://cpp.army.mil/portal/page/portal/Cost\\_Performance\\_Portal/ CPP\\_Main\\_Page/CBA\\_Portal](https://cpp.army.mil/portal/page/portal/Cost_Performance_Portal/ CPP_Main_Page/CBA_Portal).

e. CBAs are reviewed by a Cost-Benefit Analysis Review Board (CBARB) for suitability of use by a decision-maker or decision-making body. The CBARB provides its recommendation on suitability of use to the DASA(CE) who forwards the final recommendation on suitability of use to the decision-maker or decision-making body.

**9-40. Links to Principles**

a. Visionary leadership. Commanders, leaders, and managers must determine the strategies for obtaining and managing costs. Their emphasis on mission accomplishment must be complemented by an emphasis on controlling mission costs.

b. Continuous improvement and learning. CM / ABC is not yet universally understood. Leaders must foster and encourage a continuous improvement and learning mentality within their organizations. The modeling concepts and cycle of commitment and review discussed in this chapter provide a starting point for the learning process.

## Cost Benefit Analysis

### CBA—Making the Case for a Project or Proposal:

Weighing the total expected costs against the total expected benefits over the near, far, and lifecycle timeframes from an *Army Enterprise* perspective

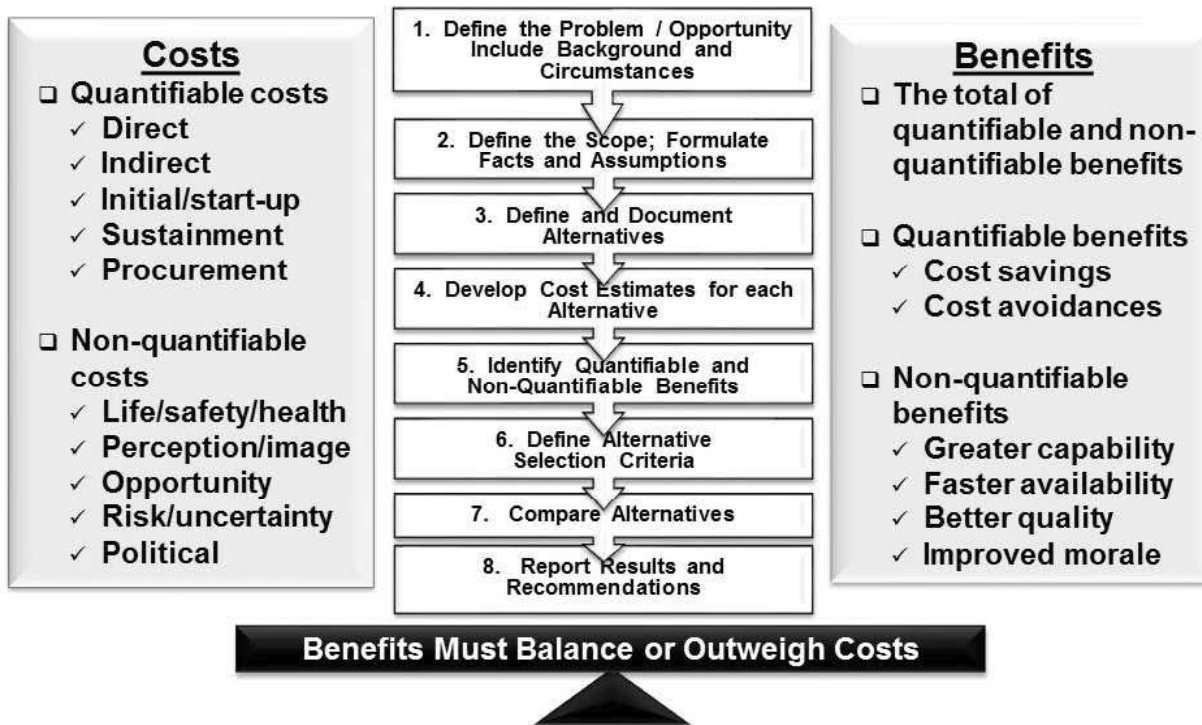

Figure 9-4. Cost-Benefit Analysis

### Section VII

#### Non-Appropriated Funds

##### 9-41. Non-Appropriated Funds Definitions

a. NAF are cash and other assets that are not appropriated by Congress. NAF come primarily from the sale of goods and services to authorized patrons, DOD military and civilian personnel and their family members, and are used to support MWR programs for the collective benefit of authorized patrons who generate them. NAF are government funds, but they are separate and apart from APF that are recorded on the books of the U.S. Treasury.

b. Non-Appropriated Fund Instrumentality (NAFI). A NAFI is a USG fiscal entity that performs an essential government function. It acts in its own name to provide, or assist other DOD organizations in providing, MWR, and other programs for military personnel, their families, and authorized civilians.

##### 9-42. Non-Appropriated Funds Instrumentality Management

a. Every NAFI is legally constituted as an “instrumentality of the United States.” Funds in NAFI accounts are USG funds and NAF property including buildings and real estate is USG property. NAF are not commingled with APF and are managed separately, even when supporting a common program or activity. This means that:

(1) Each NAFI operates under the authority of the USG in accordance with applicable federal laws and departmental regulations.

(2) Because NAFIs operate under the authority of the federal government, they are entitled to the same sovereign privileges and immunities as the USG accorded by federal law.

(3) Applicable DOD directives and implementing Army regulations have the force and effect of law.

b. A NAFI is administered and managed by military or civilian personnel acting in an official capacity. The NAFI is generally immune from federal taxes and exempt from most direct state, local, and host country taxes. It must account for and report financial operations through command and department channels. NAFI operations are subject to review by Congress. AR 215-1, Military Morale, Welfare, and Recreation Programs and Non-appropriated Fund Instrumentalities, provides more information on management of Army NAFIs.

**9-43. Fiduciary Responsibility for Non-Appropriated Funds (10 USC Section 2783)**

NAF are USG funds entitled to the same protection as funds appropriated by the Congress.

a. Individual responsibility. There is an individual fiduciary responsibility to use NAF properly and prevent waste, loss, mismanagement, or unauthorized use. This responsibility extends to all DOD personnel to include members of the Armed Forces and appropriated funded and non-appropriated funded civilian employees.

b. Violations. Commanders are responsible for the prompt detection and proper investigation of possible violations and instituting appropriate corrective action. Individuals reporting NAF violations are protected from reprisal. Commanders will take appropriate administrative action against violators. Where evidence indicates criminal conduct, commanders will refer the matter to the appropriate criminal investigative organization. Penalties for violations of waste, loss, mismanagement, or unauthorized use of NAF apply to military, appropriated funded civilian personnel, and NAF civilian personnel. They include the full range of statutory and regulatory sanctions, both criminal and administrative, and are the same as those under provisions of federal law that govern the misuse of appropriations. Reporting of suspected violations at the lowest organizational level possible is encouraged. However, reports may be made to senior management, organizational inspectors general, or to the Defense Hotline.

**9-44. Management of Morale, Welfare, and Recreation and Non-Appropriated Funds**

a. Morale, Welfare, and Recreation (MWR) and NAF are managed by a Board of Directors (BOD). Members of the BOD are the four-star commanders, the Sergeant Major of the Army, and the ASA (M&RA). The senior military member chairs the BOD. The MWR BOD develops goals and objectives, approves financing strategies, monitors performance, prioritizes NAF major construction requirements, and ensures fiduciary responsibility for MWR.

b. An Executive Committee (EXCOM) reports to the MWR BOD. The EXCOM is chaired by the G-1. The BOD structure also includes Strategic Planning, Finance, and Audit Committees that report to the EXCOM. An Investment Subcommittee reports to the Finance Committee.

**9-45. Headquarters, Department of the Army Oversight of Non-Appropriated Funds**

a. Applying various methods, the ASA (FM&C) oversees NAF. One method is by participating on the Morale, Welfare, and Recreation (MWR) Board of Directors. The DASA (FO) is a voting member of the MWR EXCOM. In addition, the Principal Deputy Assistant Secretary of the Army (FM&C) chairs the Audit Committee, and the Chief Resource Analysis and Business Practices serves on the Investment Subcommittee. Through these positions, the ASA (FM&C) influences virtually all aspects of MWR financial policy. As part of the responsibility of overseeing NAF, the ASA (FM&C) presents NAF issues to the SECARMY and CSA for decision.

b. ASA (FM&C) provides HQDA-level financial management oversight of Army-controlled by participating in the various levels and forums of the Soldier and Family Readiness Board of Directors' (SFRBOD). A representative from the Army Budget Office (ABO) participates in all SFRBOD working group level meetings where major MWR financial policy issues can be addressed. The Military Deputy for Budget advises the SFRBOD and is a voting member of the SFRBOD three-star level EXCOM. The DASA (FO) chairs the SFRBOD Audit Committee. A senior member of the ABO serves on the Investment Committee for the Army Banking and Investment Fund. The Military Deputy for Budget is also a voting member of the Army and Air Force Exchange System (AAFES) Board of Directors and its Finance Committee. The AAFES is a major revenue contributor to Army MWR. Through these positions, the ASA (FM&C) influences all aspects of MWR financial policy.

## Section VIII

### Summary, Key Terms, and References

#### 9-46. Summary

a. RM in our Army continues to evolve. New legislation, new requirements, new management initiatives, new missions, and the proviso to get the biggest bang for the buck out of Army resources continually force resource managers to develop new approaches to RM. On top of this, the application of IT has literally revolutionized the RM community. The power of the computer and its sophisticated software has provided decision makers at all levels with powerful tools to maximize the allocation and application of resources.

b. The real innovation lies, however, in the thrust of the entrepreneurial approaches being advocated in the RM community. Recognition that Army budget levels continue to decline forced us to reexamine business practices, to integrate in a far more comprehensive manner programming and budgeting, and to look seriously at ways of enhancing the productivity of the people that constitute the Army team. The MDEP concept was a forerunner of this integration effort.

c. Third-party financing, value engineering, charge-back / direct-customer payment, self-sufficiency, organizational efficiency reviews, and output focus based on unit cost are some of the concepts that allow us to examine the way we manage our Army and to do so in a more productive way to enhance the efficiency and effectiveness of the resources that Congress and the American taxpayer provide to us to forge combat capabilities.

d. This chapter summarized the more pertinent features of RM systems using a minimum of the complex terms associated with the process. We have identified the major players, the major steps they must take, and the various controls that guide their actions in the RM process particularly during the execution stage.

#### 9-47. Key Terms

a. *Resource Management (RM)*. RM is the direction, guidance, and control of financial and other resources. It involves the application of programming, budgeting, accounting, reporting, analysis, and evaluation.

b. *Obligation*. Any act that legally binds the USG to make a payment. The concept of the “obligation” is central to RM in the government. From the central concept of “obligating the USG to make a payment” springs forth the foundation of our fiscal law and the legal parameters under which the Army must operate as a part of the USG. The obligation may be for a service rendered by a contractor, the acquisition of materiel items (e.g., a tank), the construction or repair of a facility, or salary for a Soldier or civilian.

b. *Congressional Authorization*. A law passed by the Congress and signed by POTUS that establishes or continues a federal program or agency, and sets forth guidelines to which it must adhere. Generally for every FY, the Congress passes an NDAA (e.g., Public Law 111-383, Ike Skelton National Defense Authorization Act for Fiscal Year 2015), which directs by law what can be purchased, what manpower resource levels each service can have, and how many weapon and other materiel systems can be bought. It also provides additions and changes to Title 10 USC that, among other laws, guide the management of the Army and the other activities of the DOD. An authorization act does not provide the BA to draw funds from the U.S. Treasury to pay an obligation.

c. *Congressional Appropriation*. A law passed by the Congress and signed by POTUS that provides BA for the specific purpose(s) stated in the law. In the case of the annual DOD appropriations act (e.g., Public Law 111-118, Department of Defense Appropriations Act, 2015) BA is provided for a number of appropriations (e.g., OMA; Military Personnel, Army (MPA); RDT&E,A; MCA) for a specified period of time for the Army to incur legal obligations as it executes the programs authorized by Congress and other laws that guide Army operations.

d. *Cost-Benefit Analysis (CBA)*. A structured methodology for forecasting and comparing the anticipated costs and benefits of alternative courses of action in order to identify the optimum solution for achieving a stated goal or objective. The goal is to produce a strong value proposition—a clear statement that the benefits more than justify the costs, risks, and bill payers.

e. *Budget Authority (BA)*. BA is the authority to incur a legal obligation to pay a sum of money from the U.S. Treasury. BA is not “money.” The U.S. Treasury actually disburses cash only after an agency (e.g., DFAS) issues a U.S. Treasury check withdrawing money from the Treasury and thus disburses the money to pay a previously incurred obligation.

- f. *Disbursement*. Payment of an obligation of the USG.
- g. *Fiscal Year (FY)*. The FY is the government's accounting period. For the federal government, it begins on 1 October and ends on 30 September. The FY is designated by the calendar year in which it ends. For example, FY 2015 begins on 1 October 2014 and ends on 30 September 2015.
- h. *Outlays*. Outlays are the amount of money the Government actually disburses in a given FY.
- i. *Asset leverage*. The combination of government assets with private sector knowledge, expertise, equity and or financing in a venture (partnership) which results in long term benefit to the government.

**9-48. References**

- a. Army Funds Management Data Reference Guide, FY 2015, dated May 29, 2015 @ <http://asafm.army.mil/offices/office.aspx?officecode=1200>.
- b. Army Regulation 5-1, Total Army Quality Management, March 15, 2002.
- c. Army Regulation 11-2, Managers' Internal Control Program, January 4, 2010 with a Rapid Action Revision (RAR) 001, March 26, 2012.
- d. Army Regulation 37-47, Official Representation Funds of the Secretary of the Army, September 18, 2012.
- e. Army Regulation 215-1, Military Morale, Welfare, and Recreation Programs and Non-Appropriated Fund Instrumentalities, September 24, 2010.
- f. Cost-Benefit Analysis Portal @ [https://cpp.army.mil/portal/page/portal/Cost\\_Performance\\_Portal/ CPP\\_Main\\_Page/CBA\\_Portal](https://cpp.army.mil/portal/page/portal/Cost_Performance_Portal/ CPP_Main_Page/CBA_Portal).
- g. Cost Performance Portal @ [https://cpp.army.mil/portal/page/portal/Cost\\_Performance\\_Portal/ CPP\\_Main\\_Page](https://cpp.army.mil/portal/page/portal/Cost_Performance_Portal/ CPP_Main_Page).
- h. DFAS-IN Regulation 37-1, Finance and Accounting Policy Implementation, October 20, 2014.
- i. DFAS-IN Manual 37-100-14, The Army Management Structure (AMS) for Fiscal Year 2014, Basic Complete Manual, January 2, 2013.
- j. DOD Regulation 7000.14-R, Financial Management Regulation (FMR), consisting of twenty volumes, June 2011.
- k. OASA (FM&C) @ <http://www.asafm.army.mil>.
- l. OMB @ <http://www.whitehouse.gov/omb>.
- m. SECARMY Memo, SUBJECT: Consideration of Costs in Army Decision-Making, dated 24 April 2013 at <http://asafm.army.mil/Documents/OfficeDocuments/CostEconomics/guidances/cba-gd.pdf>.
- n. Standard Financial Information Structure @ <http://www.defenselink.mil/bta/products/sfis.html>.
- o. USC Titles as follows:
  - (1) Title 5 USC, Government Organization and Employees.
  - (2) Title 10 USC, Armed Forces.
  - (3) Title 31 USC, Money and Finance.
  - (4) Title 32 USC, National Guard.
  - (5) Title 41 USC, Public Contracts.
- p. USA Memo, "Establishment of the Army Cost Management Steering Group" @ [https://cpp.army.mil/portal/page/portal/Cost\\_Performance\\_Portal/ CPP\\_Main\\_Page/Cost%20Management/CM\\_Steering\\_Group>About\\_CMSG](https://cpp.army.mil/portal/page/portal/Cost_Performance_Portal/ CPP_Main_Page/Cost%20Management/CM_Steering_Group>About_CMSG).
- q. USD (C) @ <http://www.dtic.mil/comptroller>.
- r. USG @ <http://www.gao.gov/financial.html>.

**This page is intentionally left blank**

## **Chapter 10**

### **Capability Requirements and Materiel System Research, Development, and Acquisition Management**

#### **NOTE ON THIS CHAPTER**

In October 2017, the Acting Secretary of the Army, the Honorable Ryan D. McCarthy, issued Army Directive 2017-24, “Cross-Functional Team Pilot in Support of Materiel Development,” as the first step in improving the Army’s requirements development and materiel acquisition processes. He followed up this directive in November 2017 with a series of supporting acquisition reform initiatives regarding: Science and Technology, Test and Evaluation, Sustainment, Contracting, Cost Estimation, and Assessment. Additionally, the Army has convened a task force to determine the path toward the activation of a new Army Command that will oversee requirements development and some acquisition related activities. The outcome of these efforts will affect the authorities, responsibilities, and processes discussed in this chapter. Once these efforts are completed and changes are made to align the Army enterprise with senior Army leader decisions in these areas, this chapter will be re-written to reflect those changes. The online version of How The Army Runs will reflect the changes until the volume is updated in the 2019-2020 version of HTAR.

#### **Section I Introduction**

##### **10-1. Department of Defense and U.S. Army Capabilities Development and System Acquisition Management**

This chapter describes DOD and U.S. Army management key roles, missions, functions, and processes/systems used for capabilities development (CD) and Research, Development, and Acquisition (RDA) of materiel systems. These systems are simply a combination of structure, process, and culture as described below.

- a. Structure is the sum of the guidance provided by law, policy, or regulation, and the organization provided to accomplish the CD and system RDA management functions.
- b. Process is the interaction of the structure in producing the output.
- c. Culture is the cumulative sum of past practices and their impact on interpretation of guidance and attitude toward institutional changes to the system.
- d. The Army leverages the three overarching Department of Defense systems to implement doctrine, organizations, training, materiel, leadership and education, personnel, facilities, and policy (DOTMLPF-P) solutions and recommendations. These three systems (Joint Capabilities Integration and Development System (JCIDS), the Defense Acquisition System (DAS) and the Planning, Programming, Budgeting and Execution (PPBE) process must integrate/overlap to provide an effective and efficient product for warfighter consumption. The outputs of the JCIDS feed both the DAS and PPBE.

##### **10-2. Primary Purpose**

The purpose of the capability requirements and materiel acquisition systems is to provide the joint warfighter operationally effective and affordable Army capability when required. This translates into supporting the Army’s primary responsibility to field properly trained, equipped, and sustained military units to execute missions in support of the National Defense Strategy (NDS), and the National Military Strategy (NMS). These processes / systems enable the Army to develop and acquire needed warfighting

# HOW THE ARMY RUNS

capabilities that are both operationally effective and affordable, to support the national defense strategy. To facilitate an understanding of the process, this chapter will begin by highlighting some critical aspects of capabilities development.

## Section II Capabilities Integration and Development

### 10-3. Policy

The Chairman of the Joint Chiefs of Staff Instruction (CJCSI) 3170.011 mandates policy and the supporting Joint Capabilities Integration and Development System (JCIDS) Manual provides procedural guidance for the JCIDS. The Army supports JCIDS through the Army's JCIDS process discussed in Army Regulation 71-9, and Training and Doctrine Command (TRADOC) Regulation 71-20.

### 10-4. Joint Capabilities Integration and Development System

a. The JCIDS, the Defense Acquisition System (DAS), and the Planning, Programming, Budgeting, and Execution (PPBE) process form DOD's three primary decision support systems/processes for shaping military forces to support strategic guidance documents. JCIDS is a capabilities-based approach to identifying current and future capability gaps in the joint force's ability to carry out joint warfighting missions and functions. When the JCIDS process determines that DOD needs to develop new materiel solutions, the JCIDS capability requirements process interacts with the Defense Acquisition System (DAS) and the PPBE process to provide effective solutions. The procedures established in JCIDS support the Chairman, Joint Chiefs of Staff (CJCS), and the Joint Requirements Oversight Council (JROC) in advising the Secretary of Defense (SECDEF) in identifying, assessing, and prioritizing joint military capabilities-based requirements (needs).

b. JCIDS is a need driven joint capabilities-based requirements generation process. The objective is to develop balanced and synchronized Doctrine, Organization, Training, Materiel, Leadership and Education, Personnel, Facilities, and Policy (DOTMLPF-P) solutions that are affordable, militarily useful / operationally effective, supportable by outside agencies, and based on mature technology that is demonstrated in a laboratory, relevant, or operational environment. JCIDS implements an integrated, collaborative process, based on top-level strategic direction, to guide development of new capabilities through changes in DOTMLPF-P. The DOTMLPF-P Change Recommendations (DCRs) are developed and evaluated in order to optimize the joint force's ability to operate as an integrated force. If the recommendation only optimizes the Army's (not Joint) ability to operate, then a DOTMLPF-P Integrated Change Recommendation (DICR) is developed. The DICR focuses on changes that are primarily non-materiel in nature, although there may be some limited materiel changes as well. This integrated, collaborative approach requires a process that uses Joint/Services concepts and integrated architectures to identify prioritized high-risk capability gaps and integrated joint DOTMLPF-P approaches (materiel and non-materiel) to resolve those capability gaps. There are three requirements validation lanes: deliberate (standard or traditional), urgent (institutionalized), and emergent (anticipated or pending). The deliberate process uses the traditional route to identifying capability gaps and proposed solutions – the Capabilities Based Assessment process, documenting the Capabilities Based Assessment results in an Initial Capabilities Document (ICD) and / or DCR/DICR, and proceeding to a Materiel Development Decision (MDD) and an Analysis of Alternatives (AoA) to support a materiel solution decision. The remainder of the acquisition process (prototyping, design, development, production, fielding and sustainment) follows the materiel solution decision.

c. Urgent Threat Timeline. Planning for ongoing contingency operations may identify urgent operational needs (UON) which represent potential for critical mission failure or unacceptable loss of life if not satisfied by a rapidly acquired capability solution. These capability requirements may qualify for submission as Joint UONs (JUON) or DOD Component UONs for expedited validation and rapid acquisition efforts.

d. Emergent Threat Timeline. Planning for anticipated contingency operations may identify operational needs that represent potential mission failure or unacceptable loss of life once operations commence, if not satisfied by a rapidly acquired capability solution. These capability requirements may qualify for submission as Joint Emergent Operational Needs (JEON) or DOD Component UONs for expedited validation and rapid acquisition efforts.



See Figure 10-1 for a depiction of the three requirements process lanes from the JCIDS Manual.

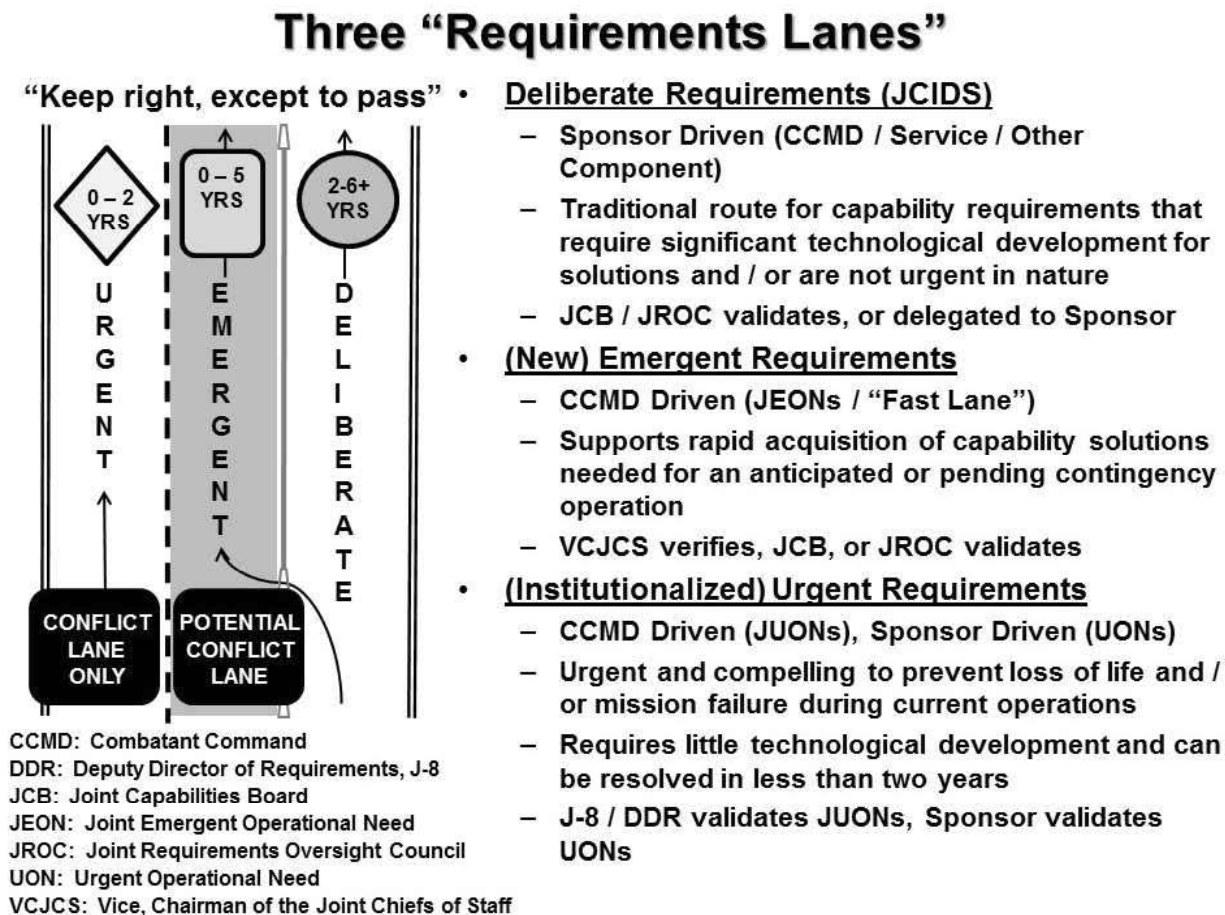

**Figure 10-1. Three “Requirements Lanes”**

f. Rapid acquisition includes activities to develop and implement capability solutions in a shorter timeframe than typical of deliberate DAS processes. Rapid acquisition activities may also include expedited procurement of Commercial off-the-shelf (COTS), Government off-the-shelf (GOTS) or Non-developmental Items (NDI) solutions, or modification/ acceleration of existing development programs initiated under the deliberate process. The Milestone Decision Authority (MDA) determines the specific acquisition process for each validated capability requirement .

g. Capabilities Based Assessment. Organizing and executing a successful JCIDS Capabilities-Based Assessment is a significant challenge. Joint Concepts are specifically designed to drive progress in the DOD, and satisfying the demands of strategic guidance poses significant challenges. For the Army, the Capabilities Based Assessment has three phases: Functional Area Analysis (FAA), or required capabilities and associated tasks, conditions, and standards; Functional Needs Analysis (FNA), or high risk / high priority capability gaps; and Functional Solutions Analysis (FSA), or potential DOTMLPF-P approaches, recommendations, solutions to mitigate or eliminate the capability gap(s). A Capabilities Based Assessment, particularly one aimed at a broad mission area, is conducted with a capable Joint team that can bring the necessary spectrum of expertise to bear on the problem needs, as follows—

(1) *Needs*. A capability required to meet an organization’s roles, functions, and missions in current and future operations.

(2) *Gaps*. An operational assessment of the current and programmed force is conducted to identify the capability requirements (based on specified operational tasks that must be performed, under what conditions, and to what standards). If a capability requirement is not satisfied by a capability solution,

then there is also an associated capability gap. Gaps are assessed in terms of risk to the mission, risk to the force (potential losses), and other important considerations such as resourcing and effects on allies.

(3) *Solutions*. Solutions include accepting risk or doing nothing, identifying non-material approaches to mitigate any of the identified capability gaps, and if needed, recommended materiel approaches, or a combination of non-materiel and materiel approaches. Ranking and timing of the needed solution(s) are important for resourcing and planning. The Capabilities Based Assessment is an analytic basis to identify capability requirements and associated capability gaps. Other forms of studies, analyses, or assessments may be used, but may need refinement to generate sufficient data for capability requirement documents.

h. Capabilities Needs Analysis (CNA). TRADOC Army Capabilities Integration Center (ARCIC) leads the execution of the CNA across TRADOC Centers of Excellence and Army Force Modernization Proponents. The CNA is the Army's integrated CBA and the primary analytical process to develop, integrate and validate the prioritized DOTMLPF-P solutions, capability gaps, and gap solution approaches to drive capabilities development and inform Army resource priorities. The CNA assesses what the Army must do as the premier land component to meet its Joint warfighting responsibilities. The CNA drives Army Capabilities Development priorities (i.e., Army JCIDS actions (ICD/CDD/CPD) and Campaign of Learning (i.e., Experimentation, S&T, Joint Warfighting Assessments, and integration evaluations) and informs the Secretary of the Army and Chief of Staff for ASA/ALT and ARSTAF Strategic Portfolio Analysis Review (SPAR) planning and POM development and resourcing priorities (see Fig.10-2).

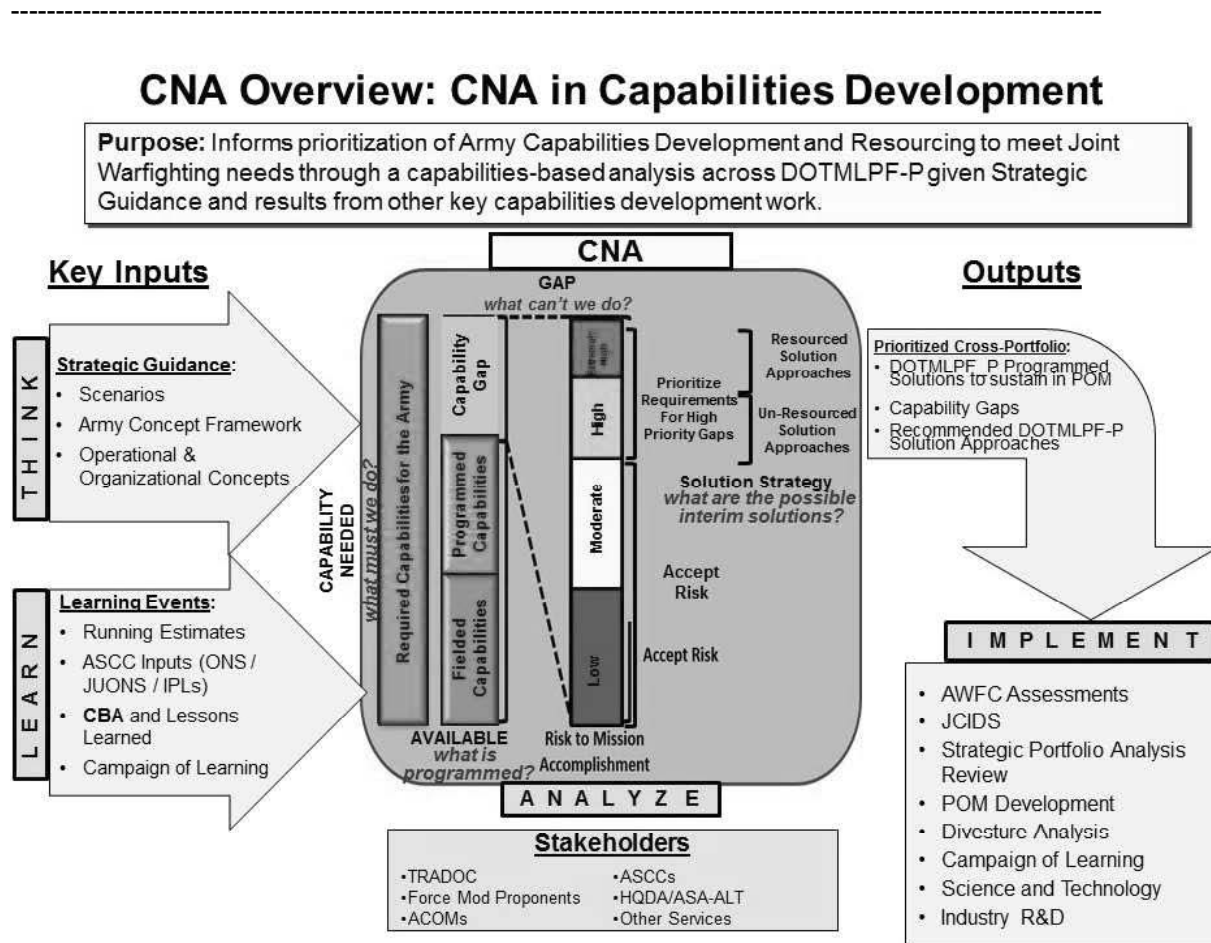

**Figure 10-2. Capabilities Needs Analysis (CNA) Overview**

# CAPABILITY REQUIREMENTS AND MATERIEL SYSTEM RESEARCH, DEVELOPMENT, AND ACQUISITION MANAGEMENT

## Section III Capability Requirements Documents

### 10-5. Generating and Documenting Requirements

Capability Requirements Documents document the Capabilities Based Assessment results. The ICD demonstrates the need for a materiel acquisition program, how the materiel will be employed, and what the materiel must be capable of doing. As the acquisition program progresses, statements of required performance and design specifications become more and more specific. The functional area focused Initial Capabilities Document (ICD) is the document that initiates the DAS. The Capability Development Document (CDD) and the Capability Production Document (CPD) are the documents that define the system capabilities needed to satisfy an approved materiel need (high-risk capability gap).

### 10-6. Initial Capabilities Document

The ICD is the most common starting point for new capability requirements. The ICD is a broad statement of functional required materiel capability (need) that can possibly support more than one developmental system. It documents the need for non-materiel and/or materiel solution approaches to resolve a specific high-risk capability gap derived from the Capabilities Based Assessment process (previously discussed). It describes capability gaps that exist in warfighting functions as described in the applicable warfighting concepts and integrated architectures. The ICD defines the capability gap in terms of the functional area, the relevant range of military operations, and timeframe under consideration.

a. The ICD summarizes the results of the Capabilities Based Assessment analysis and identifies any changes in U.S. or Allied doctrine, operational concepts, tactics, organization, and training that were considered in satisfying the identified high risk capability gap. The ICD describes why such non-materiel changes are inadequate in addressing the complete capability.

b. The ICD documents the evaluation of balanced and synchronized DOTmLPP-P (non-materiel) approaches that are proposed to provide the Required Capabilities (RC). The ICD further proposes a recommended materiel approach based on analysis of the different materiel approaches and describes how the recommended approach best satisfies the desired RC.

c. Once validated, an ICD is not normally updated, but is archived to the Joint Staff, J-8 Knowledge Management / Decision Support (KM / DS) tool database, so that all validated capability requirements documents are maintained in a single location. When validated, CDDs (described below) bring the desired capability specified in the ICD into the DAS EMD phase. The CDD then serves as the living document to carry the program and its increments through the acquisition process.

d. The ICD is limited to 10 pages and the format and detailed content instructions are provided in the JCIDS Manual. An ICD is not always required before creating successor documents, i.e., CDDs, CPDs, or Joint DCRs, if alternative studies or documentation sources make the ICD redundant. In cases where the Sponsor proposes to proceed directly to a successor document, the general content of the ICD, including capability requirement and capability gap tables, will be provided in the successor document. In cases where the Sponsor proposes to proceed directly to a CDD or CPD, the Sponsor requests an ICD waiver through the Joint Staff J-8 Gatekeeper. The Joint Staff J-8 Gatekeeper, in coordination with the MDA and validation authority, may approve an ICD waiver, and the MDA may direct in the MDD that the MSA phase of acquisition be abbreviated or eliminated, and further development of a capability solution start directly at MS A, MS B, or MS C. If the MDA directs at MDD that a program start at MS C, a CDD is not required and a CPD supports the MS C decision.

e. For capability requirements likely to be addressed by Information Systems (IS) solutions—software development, and off-the-shelf hardware, if required—Sponsors should consider the IS-ICD variant detailed in Figure 10-3. For capability requirements likely to be addressed by a mix of IS and non-IS solutions, Sponsors must use the regular ICD format and consider an IS-CDD and ICD validation to streamline the IS portion of solution development.

(1) The purpose of an IS-ICD is focused on facilitating more efficient and timely software development efforts, and is not appropriate for hardware development efforts or capturing capability requirements which span a broad scope of combined hardware, software, and DOTmLPP-P efforts.

(2) The IS-ICD is a variant of the regular ICD, implementing the “IT Box” model outlined in this section. IS-ICDs streamline the requirements process relative to IS efforts by delegating requirements oversight and document formats for subsequent documents as identified in the IS-ICD. This provides IS programs greater flexibility to incorporate evolving technologies and achieve faster responses from requirement

validation processes than is typical for other kinds of materiel or non-materiel solutions.

## IT Box Components for IS-ICD

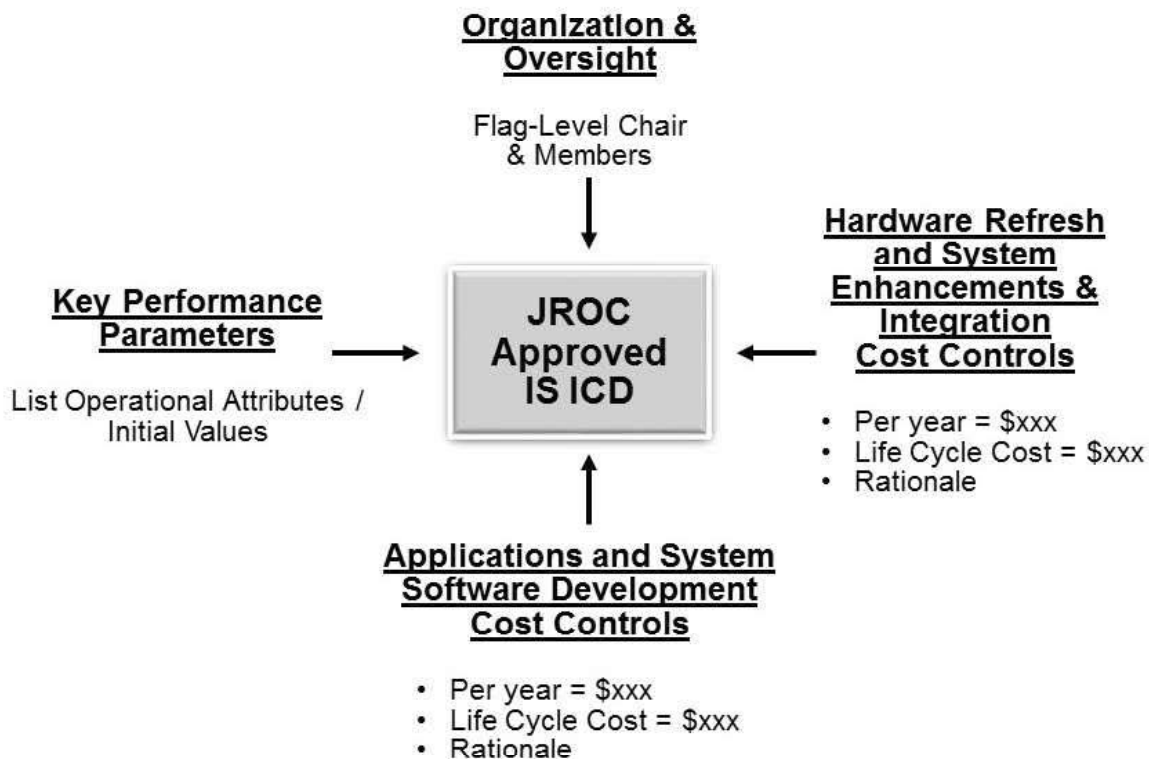

ICD: Initial Capabilities Document  
 IS: Information Systems  
 IT: Information Technology  
 JROC: Joint Requirements Oversight Committee

**Figure 10-3. Information Technology Box Components for Information Systems-Initial Capabilities Document**

- (3) The document serves as the basis for validation by the appropriate validation authority. Applicability of any potential streamlining of acquisition processes is at the discretion of the MDA.
- (4) IS-ICDs are appropriate for—
  - (a) The procurement or modification of GOTS / COTS IS products from domestic or international sources, or the development of dual-use technologies.
  - (b) The additional production or modification of previously developed U.S. and/or allied /partner-nation / other US government agency/department IS products.
  - (c) Development, integration, and acquisition of customized application software, including commercial IS capability solutions with integrated, DOD-specific performance characteristics/standards.
  - (d) All hardware associated with an IS-ICD must be COTS / GOTS.
  - (e) Hardware modifications are restricted to those necessary for system integration and enhancements to meet capability requirements specified in the IS-ICD.
  - (f) Hardware refresh due to obsolescence.
  - (g) Approaches where the capability solution involves research, development, and / or acquisition of applications systems software, and the projected life cycle costs exceed \$15 million.
  - (g) IS-ICDs with life cycle costs less than \$15 million may be sufficient for review and validation if validated requirements are needed to support budgetary requests or other purposes.
- (5) IS-ICDs streamline the requirements process relative to IS efforts by delegating requirements

# CAPABILITY REQUIREMENTS AND MATERIEL SYSTEM RESEARCH, DEVELOPMENT, AND ACQUISITION MANAGEMENT

oversight and document formats for subsequent documents as identified in the IS-ICD. This provides IS programs greater flexibility to incorporate evolving technologies and achieve faster responses from requirement validation processes than is typical for other kinds of materiel or non-materiel solutions.

(6) IS-CDD (see Fig 10-4). The purpose of an IS-CDD is focused on facilitating more efficient and timely software development efforts, and are not appropriate for hardware development efforts or capturing capability requirements which span a broad scope of combined hardware, software, and/or DOTmLPF-P efforts.

## IT Box Components for IS-CDD

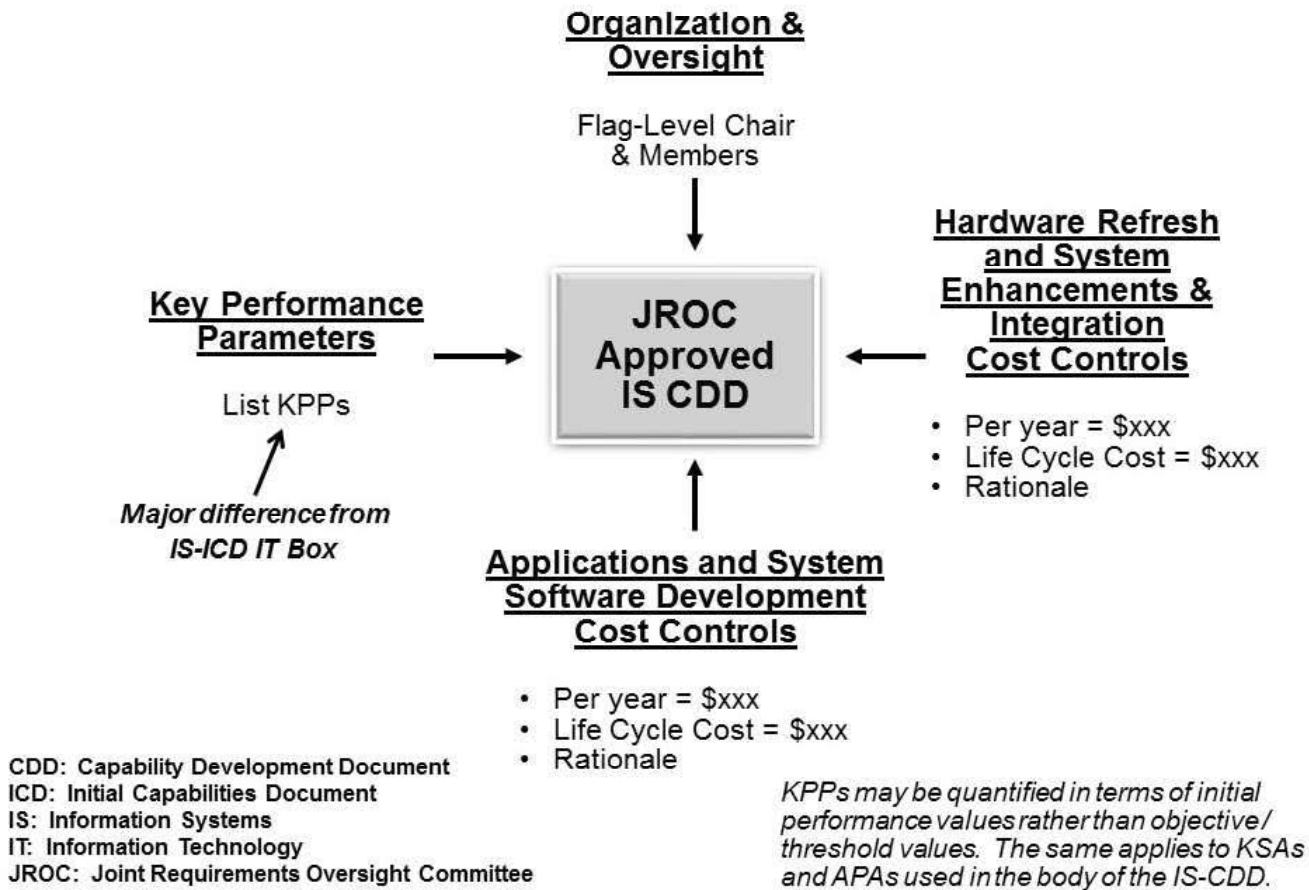

**Figure 10-4. Information Technology Box Components for Information Systems-Capability Development Document**

(a) The IS-CDD is a variant of the regular CDD, implementing the “IT Box” model outlined in the IS-ICD section of this enclosure. IS-CDDs streamline the requirements process relative to IS efforts by delegating requirements oversight for subsequent documents as identified in the IS-CDD. This provides IS programs greater flexibility to incorporate evolving technologies and achieve faster responses from requirement validation processes than is typical for other kinds of materiel or non-materiel solutions. In general, the IS-ICD is the preferred method for implementing the “IT Box” model, but:

(b) IS-CDDs may be used in cases where a validated ICD contains capability requirements which can be addressed by a combination of IS and non-IS capability solutions and the IT Box construct is applicable to the IS portion of the capability solution(s).

(c) IS-CDDs may be acceptable for MDAP/IT programs to comply with statutory requirements for a CDD while allowing for other flexibilities of the IT Box model. IS-CDDs are also appropriate for use in cases

where a validated CDD was generated before the IT-Box construct was introduced, and the Sponsor wants to revalidate under the IT-Box construct.

(d) Use of the IT Box model in a CDD does not require that predecessor capability requirement document (ICD, ORD, etc.) also use the IT Box model (i.e., conversion of a CDD to IS-CDD does not also require conversion of the related ICD to an IS-ICD).

(e) The document serves as the basis for validation by the appropriate validation authority.

### 10-7. Capability Development Document

The CDD is the warfighter's primary means of defining authoritative, measurable, and/or testable capabilities for the Engineering and Manufacturing Development (EMD) phase of an acquisition program. While the ICD guides the CDD, the CDD's primary basis is the approved Analysis of Alternatives (AoA) that identifies the best set of operationally effective and affordable system attributes. The CDD captures the information necessary to deliver an affordable and supportable capability using mature technology within a specific increment of an Acquisition Strategy (AS) – the framework (roadmap) for planning, directing, and managing an acquisition program to satisfy a validated materiel requirement.

a. A draft CDD is generated during the Materiel Solution Analysis (MSA) Phase and the final CDD is generated during the Technology Maturation & Risk Reduction (TMRR) phase of the acquisition process prior to MS B (program initiation). The CDD describes a technically mature and affordable increment of militarily useful / operationally effective capability that demonstrated in a relevant environment. The CDD supports entry into EMD phase.

b. The capabilities delivered by a specific increment may provide only a partial solution of the ultimate desired capability, therefore; the first increment's CDD must provide information regarding the strategy to achieve the full capability. Subsequent increments, leading to the full capability, are also described to give an overall understanding of the program strategy. With each subsequent increment this strategy is updated to reflect lessons learned from previous increments, changes in the warfighting concepts, or changes in the integrated architecture.

c. The CDD describes the operational capability; threat; integrated architectures; required capabilities; program support; supportability; force structure, DOTmLPF-P impact, and constraints; schedule; and program affordability for the system.

d. The CDD identifies the operational performance attributes (testable or measurable characteristics), in threshold-objective (minimum-desired) format, necessary for the acquisition community to design a proposed system and establish an Acquisition Program Baseline (APB). The CDD states performance attributes, including Key Performance Parameters (KPP) that guide the development, demonstration, and testing of the current increment. These parameters provide the "trade space" for the system as it goes through development and testing. The performance attributes and KPPs apply only to the current increment. Each increment must provide an operationally effective and useful capability in the intended mission environment that is commensurate with the investment and independent of any subsequent increment.

e. The CDD articulates the attributes, KPPs, and Key System Attributes (KSA) that are further refined in the CPD. The CDD is updated or appended for each MS B decision.

f. The CDD page limit is 45 pages, and the format and detailed content instructions are provided in the JCIDS Manual.

### 10-8. Capability Production Document

The CPD is the warfighter's primary means of providing authoritative and testable capabilities for the Production and Deployment (P&D) phase of an acquisition program. A CPD is finalized after the Post Critical Design Review (CDR) Assessment and is validated prior to the MS C (Low-Rate Initial Production (LRIP)) decision. The CPD development is guided by the ICD, CDD, developmental and operational testing results, and the Post CDR assessment. It captures the information necessary to support production, testing, and deployment of an affordable and supportable increment within an AS.

a. The CPD provides the operational performance characteristics necessary for the acquisition community to produce and field a single increment of a specific system. The CPD presents performance characteristics, including KPPs and KSAs, to guide the production and deployment of the current increment. Since a CPD applies to only a single increment of a program's development, the performance attributes, KPPs, and KSAs apply only to the increment described in the CPD. Each increment must

# CAPABILITY REQUIREMENTS AND MATERIEL SYSTEM RESEARCH, DEVELOPMENT, AND ACQUISITION MANAGEMENT

provide an operationally effective and useful capability in the intended environment, commensurate with the investment.

b. The CPD refines the threshold and objective values for performance attributes and KPPs that were validated in the CDD for the production increment. Each production threshold listed in the CPD depicts the minimum performance that the Program, Project, or Product Manager (PM) is expected to deliver for the increment based on the post-CDR system design. The refinement of performance attributes and KPPs is the most significant difference between the CDD and the CPD.

c. The CPD is an entrance criteria item that is necessary to proceed to each MS C (LRIP) decision. The CPD page limit is 40 pages, and the format and detailed content instructions are provided in the JCIDS Manual.

## 10-9. Capability Requirements Document Performance Characteristics

a. The CDD and CPD state the operational and support-related performance attributes of a system that provides the capabilities required by the Soldier – attributes so significant, they must be verified by testing or analysis. The CDD and CPD identify, in threshold-objective format, the attributes that contribute most significantly to the desired operational capability. This guides the acquisition community in making trades decisions between the threshold and objective values of the stated attributes.

b. Key Performance Parameters (KPP) are those system attributes considered most essential for an effective military capability. The CDD and the CPD contain a required number of KPPs that capture the minimum operational effectiveness and suitability attributes (testable or measurable characteristics) needed to achieve the overall desired capabilities for the system during the applicable increment. Failure to meet a CDD or CPD KPP threshold can result in the reevaluation of the selected system, program reassessment, or termination.

(1) Net-Ready Key Performance Parameters (NR-KPP) (interoperability compliance), assesses information needs, information timelines, information assurance, and net-ready attributes required for both the technical exchange of information and the end-to-end operational effectiveness of that exchange. The NR-KPP consists of measurable and testable characteristics and/or performance metrics required for the timely, accurate, and complete exchange and use of information to satisfy information needs for a given capability. A NR-KPP is developed for all Information Technology (IT) and National Security Systems used to enter, process, store, display, or transmit DOD information, regardless of classification or sensitivity. It should cover all communications, computing, and electromagnetic spectrum requirements involving the exchange of products and Services between producer, sender, receiver, and consumer for the successful completion of the Soldier mission, business process, or transaction. The NR-KPP identified in CDDs and CPDs will be used in the Information Support Plan (ISP) to identify support required from outside the program.

(2) Force protection and System survivability KPPs are Congressionally directed KPPs for all manned systems and systems designed to enhance personnel survivability in an asymmetric threat environment. Survivability attributes are those that contribute to the survivability of a manned system. This includes attributes such as speed, maneuverability, detectability, and countermeasures that reduce a system's likelihood of being engaged by hostile fire, as well as attributes such as armor and redundancy or critical components that reduce the system's vulnerability.

(3) Sustainment KPP. A sustainment KPP (materiel availability) and two mandatory supporting Key System Attributes (KSA) (materiel reliability and O&S cost) are developed for all JROC Interest programs involving materiel solutions. For non-JCB/JROC Interest programs, the sponsor determines the applicability of this KPP.

(a) Materiel reliability KSA is a measure of the probability that the system will perform without failure over a specific interval. Reliability must be sufficient to support the warfighting capability needed. Materiel reliability is generally expressed in terms of a Mean Time Between Failure (MTBF).

(b) Operations and Support (O&S) cost KSA provides balance to the sustainment solution by ensuring that O&S costs associated with materiel readiness are considered in making decisions.

(4) Training KPP ensures system training is addressed in the AoA and supporting analysis for subsequent acquisition phases and ensures projected training requirements and associated costs are appropriately addressed across the proposed acquisition program life-cycle.

(5) Energy efficiency KPP includes fuel efficiency considerations for fleet purchases and operational plans consistent with mission accomplishment. Life-cycle cost analysis will include the fully burdened cost of fuel during the AoA and subsequent analyses and acquisition program design trades.

c. Key System Attributes (KSA). KSAs are those system attributes considered most critical or essential for an effective military capability, but not selected as a KPP. KSAs provide decision-makers with an additional level of capability prioritization below the KPP, but with senior sponsor leadership control (authority is system dependent designated by the Acquisition Executive).

d. Figure 10-5, will display the linkage between the JCIDS process to the capability requirements documents, to the Defense Acquisition System (DAS).

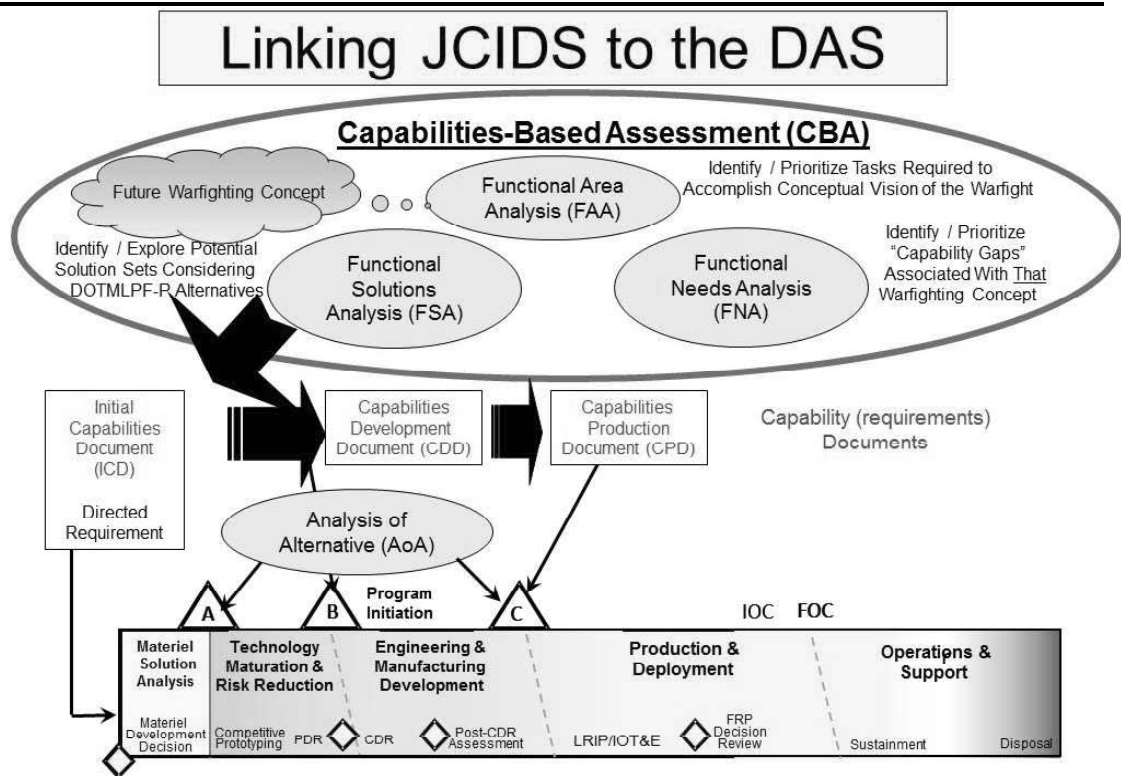

Figure 10-5. Linking JCIDS to the DAS

**Section IV**  
**Requirements Review and Validation Process**

**10-10. Joint Requirements Review and Validation Process**

a. The process of obtaining validation of JCIDS documents begins with the submission of a capability requirements document to the JS, J-8 Knowledge Management/Data System (KM / DS) tool and continues until the document is validated by the appropriate authority. Services, Combatant Commands, and other DOD organizations conducting a JCIDS Capabilities-Based Assessment analyses may generate ideas and concepts leading to draft ICDs, CDDs, CPDs, and joint DCRs. As the initiative develops into proposed DOTLmPF-P or materiel solutions to provide the desired capabilities, an FCB may task a lead Service or component with sponsoring the initiative. Further development of the proposal then becomes the responsibility of the sponsor.

b. All JCIDS documents (ICDs, CDDs, CPDs, and DCRs) are submitted to the JS, J-8 KM / DS tool by the sponsoring component. Submission of the document to the KM / DS tool triggers the JS and the gatekeeper to determine whether the document has joint implications or is sponsor unique. Normally, the document has undergone an appropriate sponsor staffing process before submission to the JS J-8 KM / DS tool.

c. The Gatekeeper. The JS J-8 Deputy Director for Requirements, serves as the “gatekeeper” of the JCIDS process. The gatekeeper, with the assistance of the JS J-8 Capabilities Requirements Division,)



# CAPABILITY REQUIREMENTS AND MATERIEL SYSTEM RESEARCH, DEVELOPMENT, AND ACQUISITION MANAGEMENT

evaluate all JCIDS documents submitted through the J-8 KM/DS tool database.

(1) JCIDS documents are submitted for gatekeeper review to determine whether the proposal affects the joint warfighter. The gatekeeper review is conducted for each document regardless of potential Acquisition Category (ACAT), previous delegation decisions, or previous JSD decisions. An ACAT is designated as ACAT I, II, or III when the materiel requirement and manner of acquisition have been identified. Title 10, Section 2430, identifies dollar criteria for determining the ACAT of a potential program. The ACAT designation determines the level of review, and who will make the milestone decisions.

## JCIDS Document Staffing Tracks

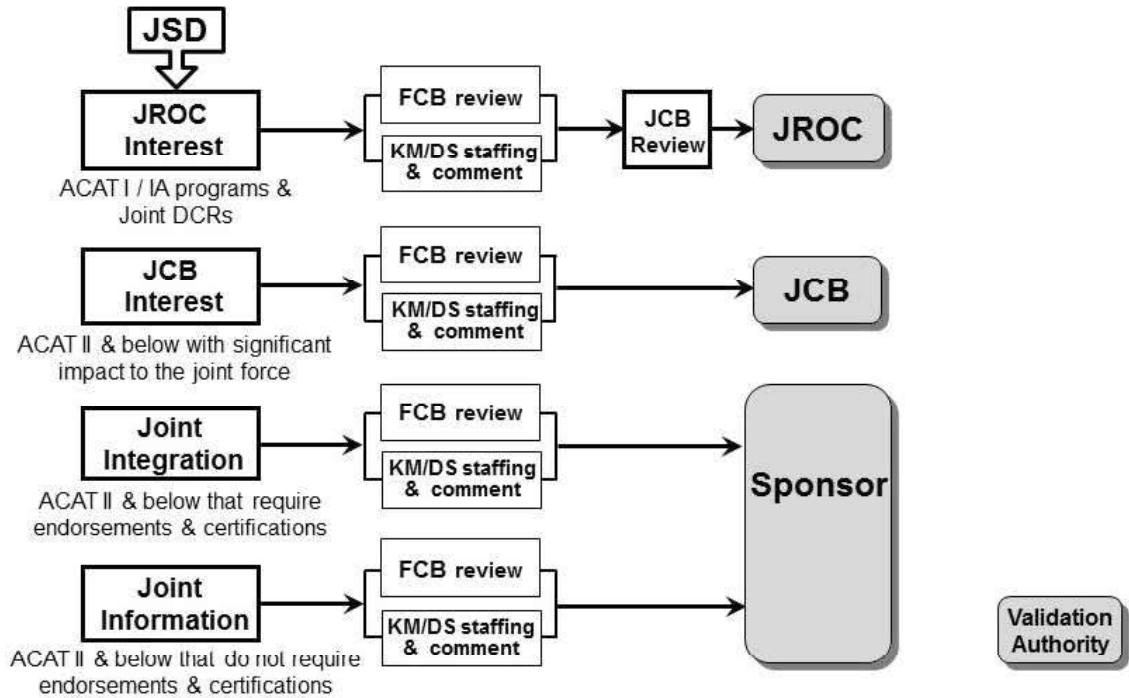

ACAT: Acquisition Category  
 FCB: Functional Capabilities Board  
 JCB: Joint Capabilities Board  
 JROC: Joint Requirements Oversight Council

Gatekeeper Makes Joint Staffing Designator (JSD) Decision After  
 Sponsor Posts Document to the Knowledge Management /  
 Decision Support (KM/DS) Tool

**Figure 10-6. JCIDS Document Staffing Tracks**

(2) Based on the content of the submission, the “gatekeeper” assigns a JSD of JROC Interest, JCB Interest, Joint Integration, and Joint Information to the ICD, CDD, CPD, or DCR submitted via the KM/DS (Figure 9).

(a) JROC Interest. This designation applies to all potential ACAT I/information assurance programs where the capabilities have a significant impact on joint warfighting or have a potential impact across Services or interoperability in allied and coalition operations. All joint DCRs will be designated as JROC Interest or JCB Interest. Capability documents designated as JROC Interest will be staffed through the JROC for validation (see Fig 10-7).

(b) JCB Interest. This designation applies to all potential ACAT II and below programs where the capabilities and/or systems associated with the document affect the joint force and an expanded joint review is required. These documents will receive all applicable certifications, including a weapon safety

## HOW THE ARMY RUNS

endorsement when appropriate, and be staffed through the JCB for validation.

(c) Joint Integration. This designation applies to potential ACAT II and below programs where the capabilities and/or systems associated with the document do not significantly affect the joint force and an expanded review is not required. Staffing is required for applicable certifications (information technology and National Security Systems (NSS) interoperability and supportability and/or intelligence) and for a weapons safety endorsement, when appropriate. All weapons and munitions will be designated Joint Integration as a minimum. Once the required certification(s)/weapons safety endorsement are completed, the document may be reviewed by the FCB. Joint Integration documents are validated by the sponsoring component.

(d) Joint Information. This designation applies to potential ACAT II and below programs that have interest or potential impact across the Services or defense agencies, but do not have significant impact on the joint force and do not reach the threshold for JCB Interest or JROC Interest. No certifications or endorsements are required. Once designated Joint Information, staffing is required for informational purposes only and the FCB may review the document. Joint Information documents are validated by the sponsoring component.

(3) The JS J-8, using the KM / DS tool, maintains a database of JCIDS documents processed through the gatekeeper function. The database includes the JSD which FCBs have equity in the proposal (if any); and the lead FCB for the proposal (if any). The database helps to ensure consistency of staffing as JCIDS proposals progress through the JCIDS process. Once the JSD has been assigned, the document moves into the staffing and validation process.



Figure 10-7. Joint Requirements Oversight Council (JROC)

# CAPABILITY REQUIREMENTS AND MATERIEL SYSTEM RESEARCH, DEVELOPMENT, AND ACQUISITION MANAGEMENT

## 10-11. Joint Requirements Oversight Council

a. The VCJCS chairs the JROC. In addition, CCDRs have a standing invitation to attend JROC sessions in an advisory role when matters related to their area of responsibility or functions are considered. Historically, the JROC has consisted of the VCJCS, the Vice Chiefs of Staff of the Army and Air Force, Vice Chief of Naval Operations, and the Assistant Commandant of the Marine Corps. In addition, the following DOD civilian officials serve as advisors to the JROC on matters of their authority and expertise: the Under Secretary of Defense (Comptroller); the Under Secretary of Defense Acquisition, Technology, and Logistics (AT&L); the Director of Cost Assessment and Performance Evaluation (CAPE); the Under Secretary of Defense for Policy; and the Director of Operational Test and Evaluation. Other civilian officials within DOD can also advise the JROC as designated by the Secretary of Defense. Furthermore, FCB participating organizations have a standing invitation to attend JROC-related meetings in an advisory role to the JROC Chairman (see Fig 10-7).

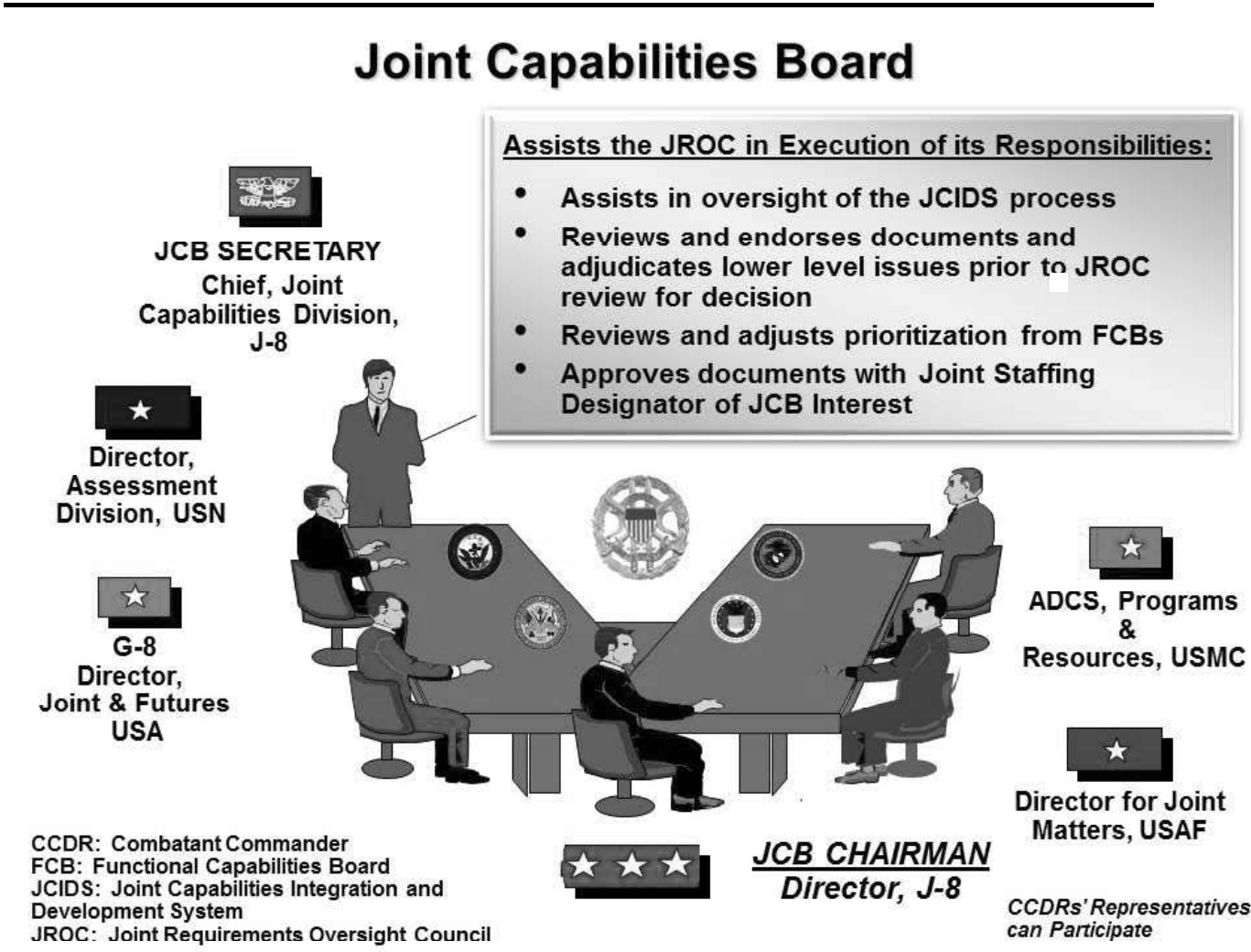

Figure 10-8. Joint Capabilities Board (JCB)

b. The JROC has continued to broaden its strategic focus to include providing top-down guidance in defining military capabilities from a joint perspective and integrating this advice within the planning, programming, and budgeting process. The JROC oversees the JCIDS process and provides advice on acquisition programs as specified in CJCSI 3170.01I and DOD 5000.01. Additionally, the JROC focuses on interacting with CCDRs on the full range of warfighting requirements and capabilities, as well as engaging DOD senior leaders who are now advisors to this council.

c. The JROC chartered the Joint Capabilities Board (JCB) to serve as an executive-level advisory board to assist the JROC in fulfilling its many responsibilities. The JCB consists of the Director, J-8, as the CJCS, and appropriate Service and CCMDs designated general / flag officer or civilian equivalent representatives. The Chief, Capabilities Requirements Division on the J-8 serves as the JCB Secretary. The JCB assists the JROC in overseeing the JCIDS process and the capabilities assessment process. The JCB reviews CBA insights, findings, recommendations, and provides both guidance and direction. On issues that have a Joint Staff Designator of JCB interest, the JCB can make decisions and for others their recommendations are provided to the JROC for final review (see Fig 10-8).

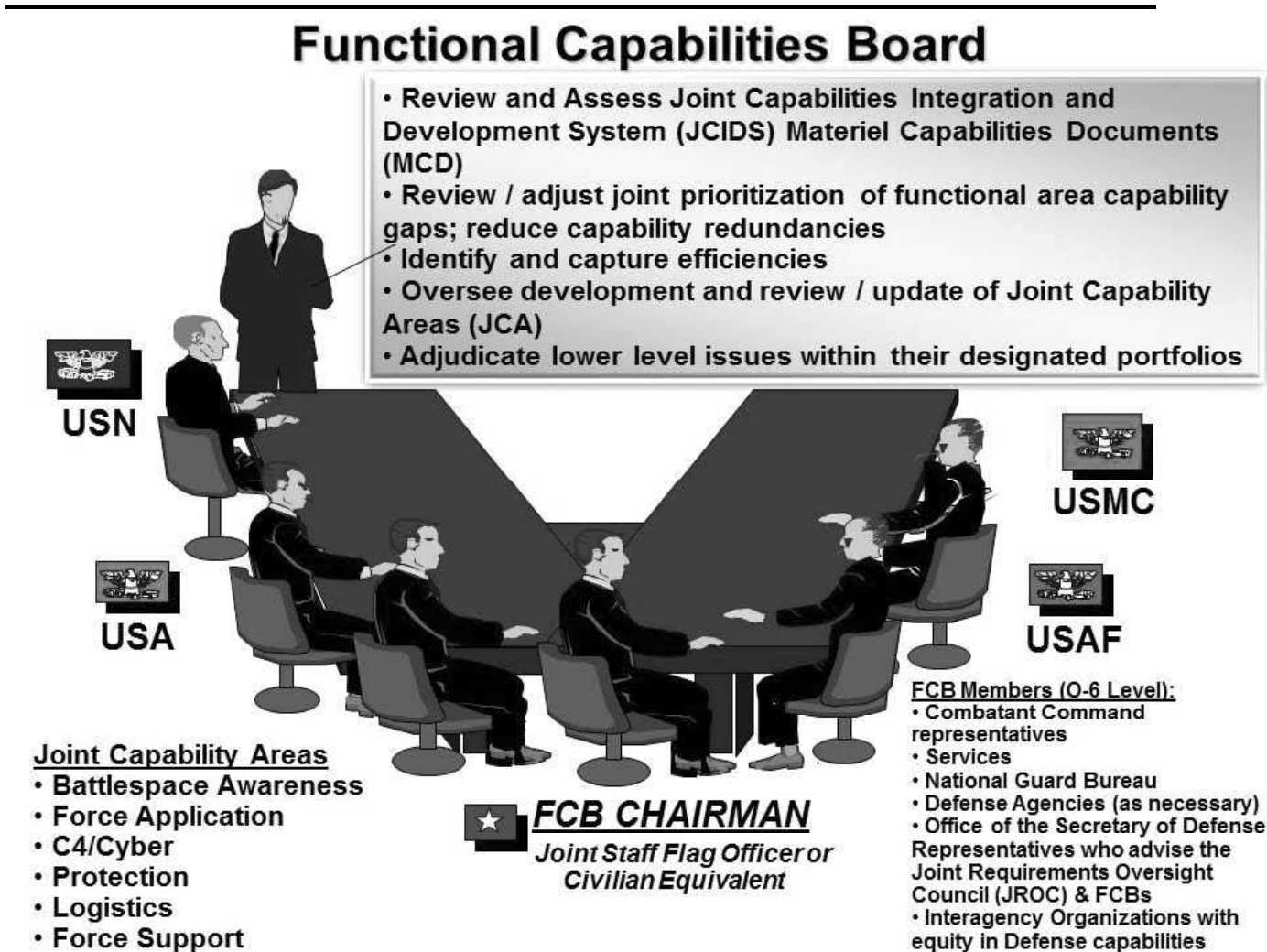

Figure 10-9. Functional Capabilities Board (FCB)

d. The FCB (see Fig 10-9) is responsible for the organization, analysis, and prioritization of joint warfighting capability needs within assigned functional areas. The FCB is an advisory body to the JCB and the JROC for JCIDS initiatives assigned with Joint Staffing Designators (JSD) of JCB Interest or JROC Interest. The FCBs, under the leadership of a Joint Staff or Functional CCMD flag officer or senior executive service civilian, serve as integrators of joint capability development and ensure that major programs are fully integrated into joint architectures from the outset. The JROC and its associated sub-organizations continue to evolve in order to remain focused on strategic issues and concepts. The overall intent is to provide more upfront guidance to ensure capabilities and systems are focused more on joint interdependency and resolve capability gaps while reducing redundancy.

# CAPABILITY REQUIREMENTS AND MATERIEL SYSTEM RESEARCH, DEVELOPMENT, AND ACQUISITION MANAGEMENT

## 10-12. Army Requirements Review and Validation Process

a. The Army has a specific process to internally review and submit capability requirements for Joint Staff consideration. If a submitted Army requirement is not designated a “Joint Interest” capability by the Joint Staff, then the Army exercises independent validation authority. Alternatively, if the Joint Staff Gatekeeper (Deputy Director for Requirements - JS J-8) assigns a Joint Staff Designator (JSD) of “Joint Capabilities Board (JCB) or Joint Requirements Oversight Council (JROC) Interest,” then the Joint Staff retains validation authority.

b. The lead organization for the implementation of the JCIDS process within the Army is the DCS, G-8/Force Development (FD), Joint and Integration Directorate. Within this Directorate, specifically, the Requirements Integration and Assessments Division (FDJ), is the single entry point for all Army and joint DOTMLPF-P requirements. FDJ is the proponent for policy development, JCIDS process oversight, and interface with the JCIDS process. Within G-8/FD, the Requirements Staff Officer (RSO) is directly responsible for leading HQDA staff integration and coordination efforts for all Army and joint DOTMLPF-P requirements. The RSO coordinates with the counterpart, the Synchronization Staff Officer (SSO) within the G-8/FD, to facilitate the transition from capabilities-based requirements development and validation to requirements solutions (execution and resourcing).

c. The process of obtaining validation of JCIDS proposals begins with the submission of a proposal by the TRADOC Army Capabilities Integration Center (ARCIC) JCIDS Gatekeeper, into the Capabilities and Army Requirements Oversight Council (AROC) Management System (CAMS) database. CAMS is the HQDA DCS, G-8/FD database driven knowledge management decision support information technology system. CAMS supports AROC document staffing and commenting from numerous users and organizations within the Army into a centralized database repository. The system allows users to view document information and monitor document progress through AROC validation until submission to the JS staffing and validation process.

d. All JCIDS proposals are entered into CAMS by the ARCIC gatekeeper. The ARCIC gatekeeper acts as the entry and exit point for all JCIDS capability documents forwarded by TRADOC and non-TRADOC proponents for validation and other Service capability documents sent to ARCIC for review. The gatekeeper manages the TRADOC staffing of the JCIDS capability documents and loads ARCIC-validated and CG, TRADOC-endorsed capability documents into the CAMS database for AROC / JROC validation. Submission of the proposal will trigger the Army gatekeeper process. The JCIDS proposal will be submitted for HQDA staffing and coordination. All proposals undergoing the review process are considered draft until they are validated by the designated validation authority.

e. All Army sponsored JCIDS proposals are submitted for HQDA JCIDS gatekeeper review to determine accuracy and completeness. Based on the content of the proposal, the gatekeeper will assign the proposal to the functional RSO and initiate Army staffing utilizing CAMS as the staffing tool. The Army review process optimally takes 90+ business days. JCIDS document flow to the AROC for initial validation and eventually for submission to the Joint Staff for validation as depicted in Figure 10-10.

f. At the conclusion of the AROC review process, the Army JCIDS gatekeeper submits the document to the Joint Staff (via the JS J-8 Knowledge Management /Decision Support –KM/DS) for staffing.

g. The HQDA JCIDS gatekeeper signals completion of Army and joint staffing and validation by publishing the approval memorandum with a Catalog of Approved Requirement Documents (CARDS) reference number. The CARDS reference number signifies a validated (official) Army materiel requirement.

## 10-13. Army Requirements Oversight Council

a. The AROC, coordinated by DCS, G-8 is responsible for advising the CSA / VCSA in the assessment and prioritization of capabilities integrated across DOTMLPF-P, to include the disposition of capability requirements documents. FDJ schedules and executes the AROC forum(s). TRADOC ARCIC continues to be responsible for the balanced development of concepts, capabilities (requirements), and products in DOTMLPF-P.

b. The AROC process is used to validate:

(1) Proposals for rapid insertion of technologies to address current capability needs when the solution extends into the Program Objective Memorandum (POM).

## JCIDS – Validation / Approval Process

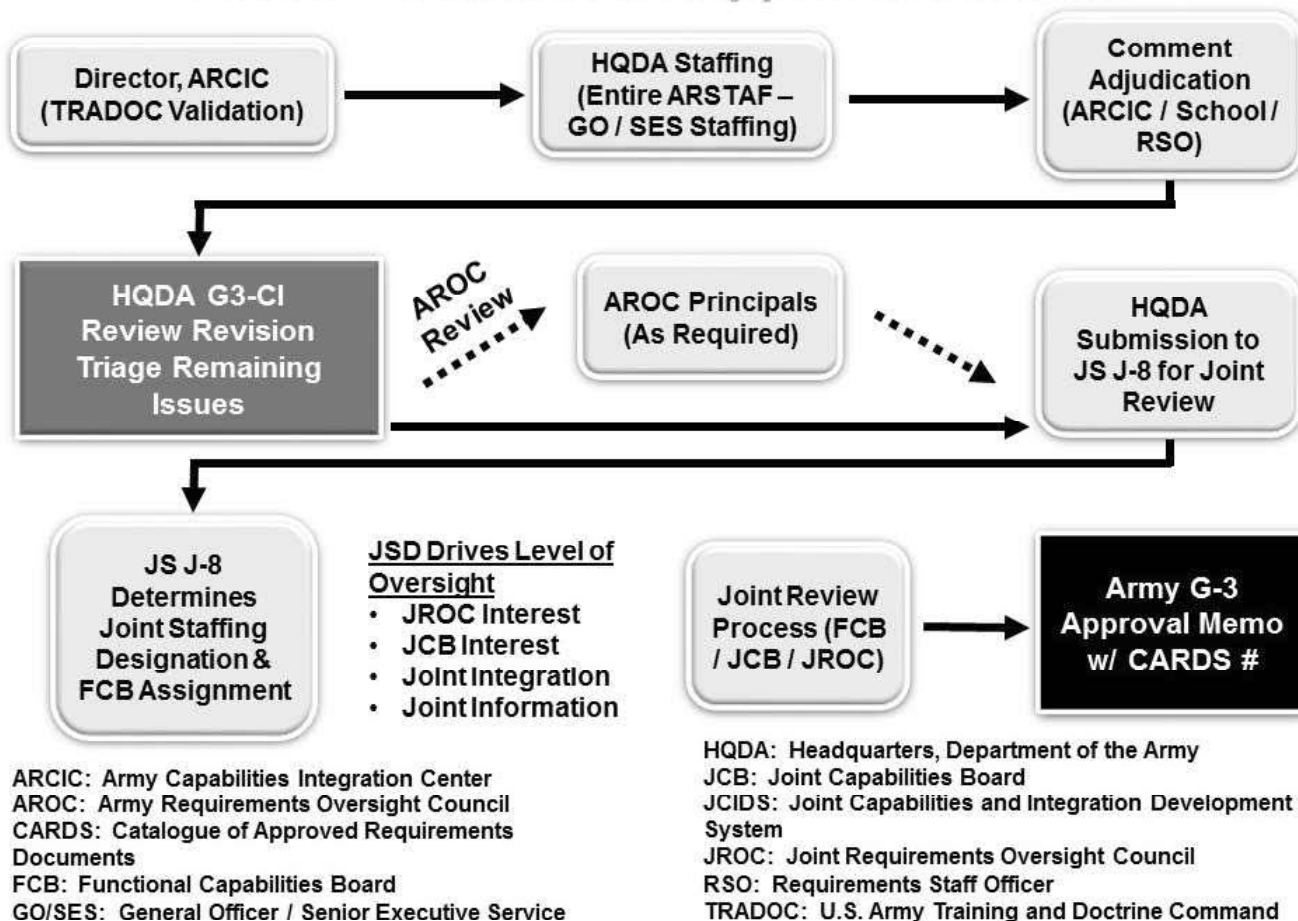

Figure 10-10. Joint Capabilities Integration and Development System – Validation / Approval Process

- (2) Strategies to resolve capability gaps and resultant changes to modernization programs and plans.
- a. The AROC validates all JCIDS documents prior to submission to the Joint Staff, J-8 JCIDS “gatekeeper” – Deputy Director, Requirements. This encompasses all JCIDS efforts including Army annexes to joint and other Service MCDs and those where an Army proponent has been designated as a joint CAPDEV.
  - b. The AROC reviews JCIDS documentation for:
    - (1) Military need and risk. The AROC reviews and provides decisions and guidance on the capability gaps identified in JCIDS proposals presented for validation. This ensures identified gaps are linked with modernization investment priorities essential for maintaining land force dominance.
    - (2) Synchronization with Army and joint modernization strategies. The AROC validates that the recommended strategies resolve capability gaps, including associated DOTMLPF-P changes, and are consistent with Army modernization strategies. Proposals must contribute to a balanced and synchronized modernization program. The AROC reviews how the recommended strategies fit into joint concepts, force modernization strategies, and investment portfolios to ensure interoperability and synergy.
    - (3) Estimated program affordability. The AROC reviews the affordability, based on the Deputy Assistant Secretary of the Army, Cost & Economics (DASA(CE) approved Cost-Benefit Analysis (C-BA), of all proposed solutions to capability gaps and programs presented to ensure that, if pursued, they are within budgeting and programming limits for development, procurement, and sustainment. The AROC considers “trades” of capability and/or performance versus cost to ensure only affordable solutions are pursued. Affordability includes potential long-term supportability requirements for the concept or system.

# CAPABILITY REQUIREMENTS AND MATERIEL SYSTEM RESEARCH, DEVELOPMENT, AND ACQUISITION MANAGEMENT

(4) Capability definition and interoperability. The AROC ensures that the operational definition of the capability gap and the proposed solution is clear and consistent with Army and joint warfighting concepts. KPPs and KSAs serve as the pivot for AROC risk deliberations on operational improvements versus costs to field a capability at the appropriate time and in the appropriate quantities. Opportunities to integrate other Service programs or alternate technologies to improve joint interoperability are also addressed in the AROC presentation.

## Army Requirements Oversight Council Structure

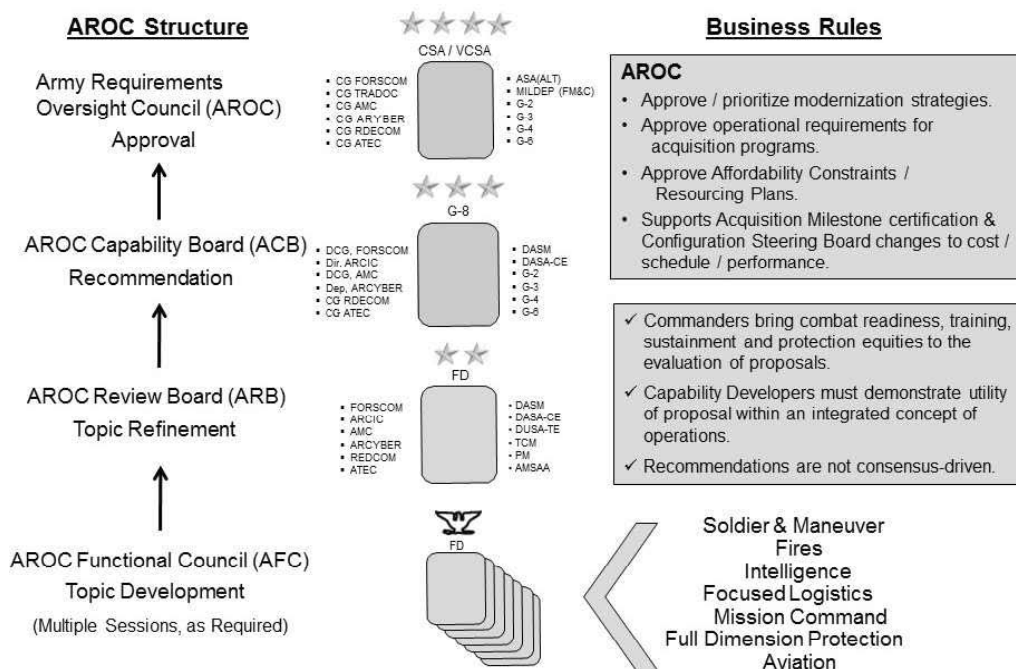

**Fig. 10-11. Army Requirements Oversight Council Structure**

- (5) The AROC consists of the following principal members:
- (a) Chief of Staff, Army/Vice Chief of Staff, Army (Chair)
  - (b) Principal Military Deputy, Office of the Assistant Secretary of Army (Acquisition, Logistics, and Technology)
  - (c) CG, Army Test and Evaluation Command (ATEC)
  - (d) Deputy Chief of Staff, G-1
  - (e) Deputy Chief of Staff, G-2
  - (f) Deputy Chief of Staff, G-3/5/7
  - (g) Deputy Chief of Staff, G-4
  - (h) Deputy Chief of Staff, G-8 (Secretary)
  - (i) DASA (Cost & Economics)
  - (j) CG, TRADOC
  - (k) CG, AMC
  - (l) CG, FORSCOM
  - (m) CG, RDECOM
  - (n) OCAR
  - (o) ARNG
  - (p) G-8/FD

## HOW THE ARMY RUNS

(q) CG, ARCYBER

(6) Permanent Advisors include: DCS, G-8/Director, Program Analysis and Evaluation (PA&E); Process Integration & Innovation (P2I); DUSA T&E; CIO/G-6; G-8 FD/DJI/DOM; TRADOC Analysis Center (TRAC); appropriate CoE; appropriate PEO; Army Materiel Analysis Agency (AMSAA); TRADOC ARCIC; and others as required.

(7) In addition, a “paper or electronic AROC” may be used, at the discretion of the AROC chair, to staff non-contentious issues.

(8) The AROC Process Review Board (APRB) serves as the AROC intermediate review body inserted prior to and immediately following the initial staffing of JCIDS proposals and as required, to review and comment on other documentation, analysis, or actions. The APRB ensures topics are suitable and mature, in accordance with AROC objectives. Also, it determines the required method of presentation for validation of the submission (formal or paper AROC). The APRB meets as required, to manage workload and ensure “value added” without unnecessarily slowing the Army JCIDS staffing process. The meeting date, time, and location supports an orchestrated staff battle rhythm and provides efficiency to the overall process by ensuring document readiness and identification of special coordination requirements prior to flag-level (1-Star) staffing, resolution of complex issues across the ARSTAF prior to moving the document into the AROC for review, and providing situational awareness to senior leaders for issues not resolved or jeopardizing successful staffing/review.

(9) The AROC process integrates and synchronizes future Army warfighting requirements to resolve capability gaps and inform modernization. AROC forums generate collaboration between multiple agencies to balance requirements with solutions within resources. G-8 (DAPR-FDJ) is the Army lead for the AROC and is responsible for scheduling all AROC venues and for publishing an EXSUM following the ARB, ACB, and AROC. In turn, FMD will disseminate an EXSUM for each event, normally within 72 hours. The RSO/Synchronization Staff Officer (SSO) will publish meeting notes following the AFC. The AROC drives collaboration through a four-tiered review process (Fig. 10-11):

- AROC Functional Council (AFC): COL/GS15 Level
- AROC Review Board (ARB): 1/2-Star Level
- AROC Capabilities Board (ACB): 3-Star Level
- Army Requirements Oversight Council (AROC): 4-Star CSA/VCSA Level

a. A DCS, G-8 Directorate of Materiel (DOM) Hardware Division Chief chairs the AFC. This 0-6 level group is chartered with developing recommendations on warfighting capabilities (review and recommend validation of requirements documents, emergent requirements, resourcing plans, achieving portfolio balance) for ARB, ACB, and AROC review.

b. AROC Review Board. The DCS, G-8 Director, Force Development (G8/DAPR-FD) or his designee chairs the ARB. This 1-2-Star board is chartered with achieving balance within Capability Portfolios. The board reviews AFC recommendations, validates the capability proposal, forwards Acquisition Category (ACAT) I/ II/ III and Special Programs to the ACB for decision, identifies and assesses the priority of warfighting capabilities, considers alternatives to acquisition programs (cost, schedule, performance), and reviews resourcing plans.

c. AROC Capabilities Board: The DCS, G-8 chairs the ACB. This 3-Star board is chartered with achieving balance within the Materiel Portfolios (across G-8 Director of Materiel (DOM Divisions). It reviews ARB recommendations, validates ACAT I/ II/ III Major Automated Information System (MAIS) / Non-Standard Equipment programs, forwards Major Defense Acquisition Programs and Special Interest Programs to the AROC, identifies and assesses the priority of warfighting capabilities, considers alternatives to acquisition programs (cost, schedule, performance), and validates resourcing plans.

d. Army Requirements Oversight Council (AROC). Either the CSA or VCSA chair the AROC. This 4-Star board is chartered with achieving balance between near term and future force readiness. It reviews ACB recommendations, validates Major Acquisition Programs and special interest topics, identifies and assesses the priority of warfighting capabilities, considers alternatives to acquisition programs (cost, schedule, performance), and approves resourcing plans.



# CAPABILITY REQUIREMENTS AND MATERIEL SYSTEM RESEARCH, DEVELOPMENT, AND ACQUISITION MANAGEMENT

## Section V Urgent and Emergent Operational Need Validation

### 10-14. Urgent and Emergent Operational Needs Requirements

a. An Urgent Operational Need (UON) encompasses capability requirements that are identified by a DOD Component as impacting an ongoing or anticipated contingency operation. If left unfulfilled, the resulting capability gaps can potentially cause loss of life or critical mission failure. Different DOD Components may use different terms to describe an UON.

b. DOD and the Army continue to improve and adapt their capabilities and materiel developments processes in response to Combatant/Operational Commanders urgent needs. The deliberate JCIDS and DAS processes acquire weapons systems using traditional DOD processes, usually taking five to seven years or more, even when the system uses maximum streamlining. Sometimes, the warfighter needs a new capability as soon as possible. When operational commanders, in a conflict or crisis, report situations that put life at risk or risk mission failure, every military Service has responded with its own rapid response approach. When the situation is a joint, theater-wide problem, the JUON/JEONS processes apply.

c. Joint Urgent Operational Needs (JUON) are urgent operational needs identified by a Combatant Commander (CCDR) affecting two or more DOD components involved in an ongoing overseas contingency operation. The JUON purpose is to identify and subsequently gain JS validation and resourcing solution, usually within days or weeks, to meet a specific high priority CCDR need. Rapid validation and resourcing of a JUON is a time-sensitive process in support of a CCDR involved in a combat-related ongoing operation. The JUON rapidly validates resources and fields urgent operational solutions that fall outside of the established Service processes. This process is not intended to compete with any of the current Service processes, but rather to complement them.

d. Joint Emergent Operational Needs (JEONs) are identified by a CCDR as inherently joint and impacting an anticipated or pending contingency operation. The scope of a JUON/JEON will be limited to addressing urgent operational needs that fall outside of the established Service processes; and most importantly, if not addressed immediately, will seriously endanger personnel or pose a major threat to ongoing operations. They should not involve the development of a new technology or capability; however, the use of "off-the-shelf" items or the acceleration of a science and technology effort, JCTD or minor modification of an existing system to adapt to a new or similar mission is within the scope of the JUON/JEON validation and resourcing. The JUON/JEON staffing/validation process is shown in Figure 10-12.

### 10-15. Joint Urgent Operational Need / Joint Emergent Operational Need Framework Process

Following confirmation that the JUON / JEON meets the appropriate entry criteria, one or both are assigned directly to a Lead FCB for review. JEONs, however, are first confirmed by the VCJCS, via the Joint Staff J-8 JCIDS Gatekeeper and DJ-8. The VCJCS will identify the validation authority as the JCB or JROC. Once the VCJCS provides confirmation that the JEON may use the emergent process, JEONs are assigned to a Lead FCB and the Joint Rapid Acquisition Cell (JRAC) for collaborative review. The Lead FCB, in collaboration with the JRAC, assesses the validity of the JUON or JEON and identifies potential solution approaches that can satisfy the capability requirement in the requested timeframe. The Lead FCB updates the FCB Joint prioritization to reflect the placement of the new capability requirement(s) within their priority list. At the end of their assessment, the Chair of the lead FCB, with a JRAC representative makes a recommendation to the validation authority either for or against validation.

## Rapid Response Framework

The JUON / JEON Process Consists of Four Phases:

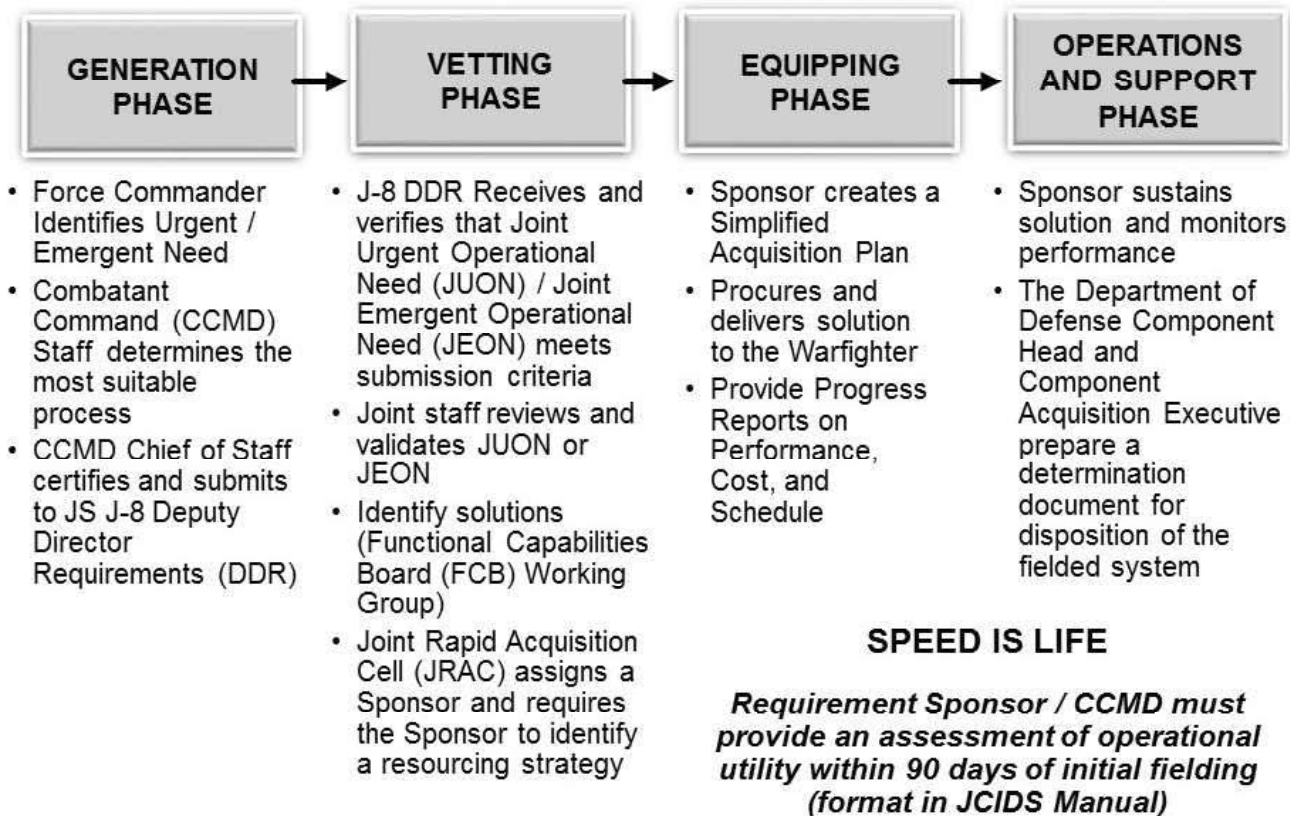

Figure 10-12. Rapid Response Framework

(1) The validation authority will make one of the following decisions:

(a) Validate the JUON/JEON. The validation authority validates that the urgency of satisfying the identified capability requirements to support ongoing or anticipated contingency operations precludes the use of the deliberate requirements validation process. Validation of the JUON/JEON allows the JRAC to proceed with assigning a solution Sponsor to rapidly fund, develop, and field a capability solution.

(b) Validate part of the JUON/JEON. If it is clear that the Sponsor's capability requirement is best validated through a mix of urgent and deliberate requirements validation processes, the validation authority will validate part of the capability requirement as a JUON/JEON, and recommend the Sponsor resubmit the remainder of the capability requirement for validation in the deliberate requirements validation process.

(c) Reject the JUON/JEON. If the JRAC, FCBs, or validation authority anticipate technology challenges or other issues which would prohibit the fielding of a militarily useful solution in an appropriate timeline, or if the validation authority determines that the criteria for being a JUON/JEON are not met, the validation authority rejects the capability requirement with a recommendation that the Sponsor accept risk, adopt a non-materiel approach, or pursue the capability requirement through the deliberate requirements validation process.

(2) After the Joint Staff J-8 receives the JUON/JEON, the FCB triages the JUON/JEON. After the triage analysis confirms the need is urgent and compelling, the Joint Staff J-8 validates the JUON/JEON and forwards it to the JRAC to determine the resourcing strategy, and then to the appropriate Service or Agency for action. The Senior Integration Group (SIG) is the single authority for prioritizing and directing

# CAPABILITY REQUIREMENTS AND MATERIEL SYSTEM RESEARCH, DEVELOPMENT, AND ACQUISITION MANAGEMENT

action to fulfill DOD urgent needs.

c. The Sponsor submits an abbreviated acquisition plan to the JRAC and to the Joint Staff for approval. The Sponsor then procures and delivers a solution and support package to the warfighter.

d. The Sponsor sustains the JUON/JEON solution in the field and monitors performance, cost, and schedule for up to 24 months. The Sponsor and supported CCMD must provide an operational utility assessment to the Joint Staff within 90 days of initial fielding. The FCB, Interim sponsor, and CCMD prepare and conduct a capability review. This review informs the final disposition of the materiel solution.

## **10-16. Joint Rapid Acquisition Cell / Senior Integration Group**

a. Joint Rapid Acquisition Cell (JRAC): The JRAC is chartered to break through the institutional barriers of providing timely, effective support to operational commanders. The cell is not attempting to introduce a new acquisition/procurement process; however, it is attempting to push critical JUONs/JEONs through the existing DOD process. The USD(AT&L) and the USD (Comptroller) established the JRAC based on Deputy Secretary of Defense (DEPSECDEF) guidance. Membership consists of 1-Star-level or senior executive representatives from the Joint Staff, CCMDs, and each of the Services, empowered to go back to their organizations and carry out the JRAC's decisions.

b. The cell works directly with the CCMDs to meet certified operational critical DOTMLPF-P (primarily materiel and logistics) requirements. The cell selects and focuses on high priority JUONs/JEONs. The goal is to act on requests within 48 hours so that a contract is awarded and goods and services are delivered within a two year period. All incoming requests for an urgent operational need must be validated and prioritized by the CCMD before forwarding to the JS via SIPRNET. The cell tracks how quickly the military responds and reports directly to the SECDEF through the DEPSECDEF and the Warfighter SIG.

c. Senior Integration Group (SIG). Building on the previous establishment and success of the JRAC to resolve requests from operational forces for urgently needed capabilities, OSD, in August 2012, formally established the Warfighter SIG. The Warfighter SIG is responsible for leading the response to CCMD UONs, and must recognize, respond to, and mitigate the risk of operational surprise associated with ongoing or anticipated near-term contingency operations. The SIG is expected to help speed up the process of developing ways to fill JUONs/JEONs, focusing on solutions that are capable of being fielded within two years. The DEPSECDEF serves as the chair of the Warfighter SIG, with the director of the JRAC serving as executive secretary. DOD's highest priority is to provide warfighters involved in conflict or preparing for imminent contingency operations with the capabilities urgently needed to overcome unforeseen threats, achieve mission success, and reduce risk of casualties. Responding to an urgent operational need occurs in three steps. The Warfighter SIG oversees, prioritizes, and facilitates these steps:

(1) First, the need or requirement is validated.

(2) Second, a valid solution, consisting of a combination of materiel solution and Tactics, Techniques, and Procedures (TTP), is identified.

(3) Third, the solution must be rapidly executed, including completing any development (necessarily minimal, given the timeline), acquisition, identification, and prioritization of funding, training, and fielding. The Co-Chairs of the Warfighter SIG will prioritize and direct actions to meet urgent requirements and to integrate DOD-wide efforts to manage tThis is a Secretary of Defense signed determination that is made in response to a documented deficiency following consultation with the Joint Staff.

d. Rapid Acquisition Authority (RAA). Congressional legislation uses the term Rapid Acquisition Authority to describe measures with respect to procurement that the SECDEF can take to eliminate a combat capability deficiency that has resulted in combat fatalities. This Rapid Acquisition Authority, as well as the DOD Overseas Contingency Operations (OCO) funding, are the primary sources of funding for the accelerated capabilities and materiel development initiatives, discussed in this chapter, responding to unforeseen urgent operational needs of the military and coalition forces engaged in overseas contingency operations. RAA should be considered when, within certain limitations, a waiver of a law, policy, directive, or regulation will greatly accelerate the delivery of effective capability to the warfighter in accordance with section 806(c) of P.L. 107-314, the institutional response to operational surprise.

## HOW THE ARMY RUNS

### 10-17. Component Urgent Operational Need: Army Operational Needs Statement / Army Requirements and Resourcing Board Process

Services use various methods to shorten the acquisition timelines to meet urgent and compelling needs during crisis and conflict (e.g., Air Force Urgent Operational Need (UON), Marine's Urgent Universal Need statement (UUN), Navy's Urgent Operational Need (UON), and USSOCOM's Combat-Mission Need Statement (C-MNS)). The ONS is the Army's UON process/approach.

a. An Army capability request to HQDA constitutes a request for a materiel and/or non-materiel solution to correct a deficiency or to improve a capability that impacts upon mission accomplishment. These capability requests come to HQDA via the SIPRNET-based Army "start to finish" Equipment Common Operating Picture (ECOP) database and fall into two general categories; authorized/pre-validated Equipment Sourcing Document (ESD) and the ONS. The final validation, prioritization, and resourcing decision for these capability requests are made by the AR2B.

b. The Army Requirements and Resourcing Board (AR2B) (see Fig 10-13), is the mechanism (forum) for validating, prioritizing, and resourcing critical operational needs (ONSs and ESDs) for rapid senior leadership decision-making (accelerated fielding solutions) in support of a named operation. The AR2B identifies solutions in the year of execution and/or budget year that require possible resource realignment.

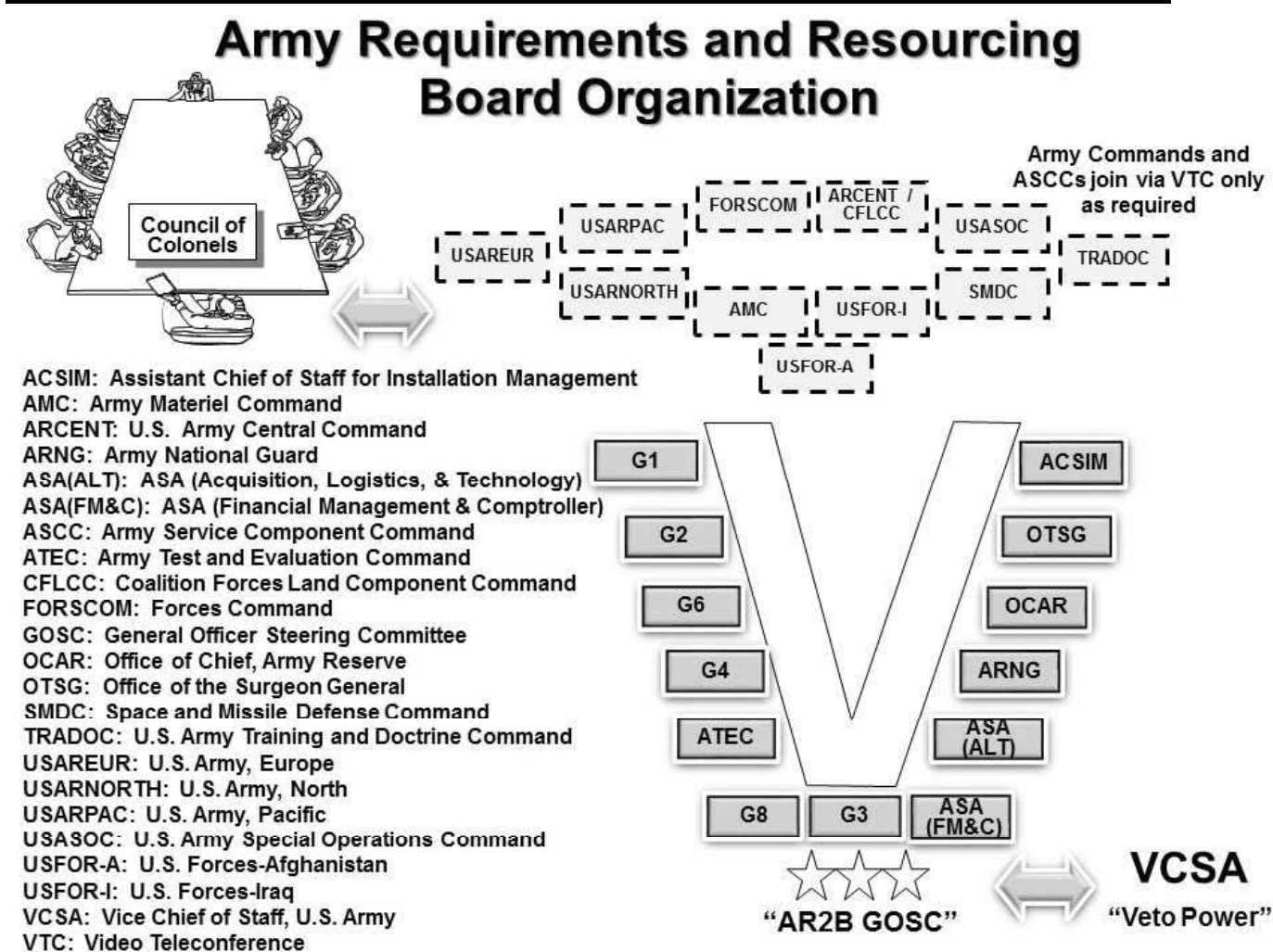

Figure 10-13. Army Requirements and Resourcing Board Organization

c. Authorized / pre-validated equipment sourcing requests (unit shortages or pre-approved items authorized by HQDA. Deployed and deploying units or other HQDA designated high priority units, may

# CAPABILITY REQUIREMENTS AND MATERIEL SYSTEM RESEARCH, DEVELOPMENT, AND ACQUISITION MANAGEMENT

submit ESDs for authorized/pre-validated equipment (e.g., Modification Table of Organization and Equipment (MTOE) shortages, Table of Distribution and Allowances (TDA) shortages, Brigade Combat Team (BCT) Basis-Of-Issue Plan (BOIP) shortages, or other equipment shortages already validated by HQDA.

d. Operational Needs Statements (ONS). Operational field commanders use an ONS to document the urgent need for a materiel and/or non-materiel solution to correct a deficiency or to improve a capability that impacts upon mission accomplishment in overseas contingency operations.

(1) The ONS provides an opportunity for the operational field commander (O6 level) to initiate the HQDA AR2B process via the Army ECOP database.

(2) The response to an ONS is based on an ARSTAF validation supported by TRADOC, Army Material Command (AMC), and MATDEV reviews. HQDA AR2B determines validity of the need, availability of technology, and sourcing of resources to fill the requirement. If the need is determined to be critical and can be resourced, a directed requirement may result.

(3) All ONS are reviewed by the CAPDEVs/TNGDEVs to determine applicability to future requirements or continuing need for which a standard requirement and acquisition is needed. If validation of the ONS indicates that the concept has potential for Army-wide application and development of a new system is appropriate, TRADOC ARCIC will initiate a functional area ICD

## 10-18. Directed Requirements

a. If operational analysis and assessment of an ONS or JUON solution or results of an Advanced Technology Demonstration (ATD) or Joint Capability Technology Demonstration (JCTD), indicate a specific, limited but necessary, urgent need exists, HQDA senior leadership may prepare and issue a directed requirement for a capability having application within the Army. While JCIDS capabilities compete in the Army prioritization process for program funding, HQDA senior leadership will specify the funding source and priority for a directed requirement. Requests for directed requirements will be presented through the APRB, AR2B or AROC for decision.

b. The scope of a directed requirement will be limited to addressing urgent operational needs that, fall outside of the established JCIDS process, and if not addressed immediately, will seriously endanger personnel or pose a major threat to the success of ongoing operations. A directed requirement should not involve the development of a new technology or capability; however, the acceleration of an ATD or JCTD (previously discussed), is within the scope of the directed requirements process.

## Section VI

### Materiel Systems Acquisition

## 10-19. Department of Defense System Acquisition Policy

The DOD Defense Acquisition System (DAS) establishes a management process to translate user needs (broadly stated functional high risk capability gaps developed in the JCIDS or business needs responding to new ways of doing business) and technological opportunities (developed or identified in the S&T program based on user needs) into reliable and sustainable systems that provide capability to the user.

a. The intent is to ensure that acquisition of Defense systems is conducted efficiently and effectively in order to achieve operational objectives of the U.S. Armed Forces in their support of national policies and objectives. The Department of Defense Directive 5000.01, The Defense Acquisition System (certified current as of 20 Nov 2007); and DOD Instruction 5000.02: Operation of the Defense Acquisition System (7 January 2015), Incorporating Change 1 and 2 (effective 26 January 2017 and 2 February 2017 respectively), DODI 5000.02 emphasizes "Tailoring" of program structures, content, and decision points to the product being acquired. The basic structure of the acquisition system remains unchanged from the previous model (December 2008), however, with minor exceptions. The defense acquisition tasks never really change:

- (1) Identify a need or desire for a new product.
- (2) Reduce the technical risk to an acceptable level.
- (3) Develop and test the product.
- (4) Field the product.
- (5) Sustain and dispose of the product overtime.

# HOW THE ARMY RUNS

b. Army Regulation (AR) 70-1 (16 June 2017) provides Army Acquisition policy for materiel and information systems. AR 70-1 governs research, development, acquisition and life-cycle management of Army materiel to satisfy validated Army requirements.

c. An acquisition program is defined as a directed, funded effort designed to provide a new, improved or continuing weapon system or IT system capability in response to a validated operational need. Acquisition programs are divided into three Acquisition Categories (ACATs), which are established to facilitate decentralized decision-making, execution, and compliance with statutory and regulatory requirements (see Fig. 10-14 & 15). The critical decisions concerning Acquisition Category (ACAT) ID programs that are post MS A before 1 Oct 16 or SecDef designated DAE as MDA for programs pre-MS A after 1 Oct 16 and selected ACAT IA programs (until 30 Sep 17) and Business Category I programs are governed/advised by the Defense Acquisition Board (DAB). ACAT 1A Programs (to include IAM/IAC), that are IT related systems or Defense Business Systems will be governed under DoDD 5000.75.

d. Acquisition phases provide a logical means of progressively translating broadly stated mission needs into well-defined system-specific requirements and ultimately into operationally effective, suitable, and survivable systems. An acquisition program can enter the system at any phase or Milestone (MS), based on the maturity of the needed technology or the demonstrated viability of possible materiel solutions under consideration. All the tasks and activities needed to bring the program to the next MS occur during acquisition phases. A MS is the major decision point that initiates the next phase of an acquisition program.

## Acquisition Categories (ACATs)

### Major Defense Acquisition Programs (MDAPs)

<u>Program Category</u>	<u>Primary Criteria</u>
<u>ACAT I</u> * (27) <u>ACAT ID</u> (4) <u>ACAT IC</u> (23)	\$ = FY14 Constant RDTE > \$480M <u>or</u> PROC > \$2.79B (PEO / PM Managed; Includes all planned increments)
<u>ACAT IA</u> * (8) <u>ACAT IAM</u> (4) <u>ACAT IAC</u> (4)	FY Program Costs > \$40M <u>or</u> Total Program Costs > \$165M <u>or</u> Total Life-Cycle Costs > \$520M (PEO / PM Managed; Includes all planned increments)

Title 10 Sect #2430



\*Pending update in DoDI  
 5000.02 January 07, 2015  
 Incorporating Change 4 (DRAFT)

C: Component  
 D: Defense Acquisition Board  
 IAM: Major Automated Information System  
 PEO: Program Executive Officer  
 PM: Program/Project/Product Manager  
 PROC: Procurement  
 RDTE: Research, Development, Testing, and Evaluation

# Acquisition Categories (ACATs)

## Major Systems

<u>Program Category</u>	<u>Primary Criteria</u>
<u>ACAT II * (59)</u>	\$ = FY14 Constant
<u>ACAT II</u>	RDTE > \$185M or PROC > \$835M

---

## Non - Major Systems

<u>ACAT III * (637)</u>	• All acquisition programs that are not classified as a MDAP or Major System (ACAT I or II) • Includes less than major AIs • No Fiscal Criteria
<u>ACAT III</u>	

Note: ACAT IV has been retained as a designation for internal use by Department of the Navy (includes Marine Corps)

1.

### Figures 10-14 & 10-15. Acquisition Categories

---

## Section VII Materiel Systems Science and Technology

### 10-20. Department of Defense Science and Technology

Maintaining a technological edge has become even more important as high technology weapons have become readily available on the world market. In this environment, it is imperative that joint forces possess technological superiority to ensure success and minimize casualties across the broad spectrum of engagements. Similarly, our warfighting capabilities 10 to 15 years from now will be substantially determined by today's investment in S&T.

### 10-21. Army Science and Technology

The Army's S&T investments support Army unified land operations focusing on the future force while, at the same time, seeking opportunities to provide advanced technology to the current force. This dual strategy requires a dynamic technology investment portfolio that is strategically aligned with the Army's future operational capability needs and that maintains an awareness of the lessons learned from current overseas contingency operations. Fundamentally, Army S&T programs are seeking to provide solutions that enable faster, lighter, and smarter systems.

a. Soldiers benefit today from technologies that emerged from the Army's past investments. S&T exploits transition opportunities by accelerating mature technologies derived from ongoing efforts. Also, Army S&T leverages the expertise of scientists and engineers to develop solutions to unforeseen problems encountered during current operations.

b. The ultimate goal of the Army's S&T program is to provide the Army with a winning edge on the battlefield. The accelerating pace of technological change continues to offer significant opportunities to enhance the survivability, lethality, deployability, and versatility of Army forces.

c. Army S&T programs are an integral part of capabilities development and system acquisition management. The S&T program consists of three stages – basic research (6.1), applied research (6.2),

and advanced technology development (6.3). The identifiers—6.1, 6.2, etc.—are commonly used for identifying funds, but they are also used as a shorthand technique by members of the Research and Development (R&D) community to identify levels of research development. The 6.1, 6.2, and 6.3 categories are known as the “tech base.” Basic research (6.1) includes all efforts of scientific study and experimentation directed toward increasing knowledge and understanding in those fields related to long-term national security needs. Applied research (6.2) includes all efforts directed to the solution of specific military problems, short of major development projects. Advanced technology development (6.3) includes all efforts directed toward projects, which have moved into the development of hardware for testing of operational feasibility.

(1) Army S&T has been at the forefront in adapting technology for urgent operational needs. DOD scientists and engineers continuously harvest materiel solutions from past investments. They also provide extraordinary technical expertise resulting in the development and integration of technologies. Army S&T provides the technology for many of the upgrade and modernization programs for existing systems.

d. A mainstay of the Army strategy for military technology is a viable in-house research capability. Research, Development, and Engineering Command (RDECOM), Research, Development, Engineering Centers (RDEC) and laboratories are the key organizations responsible for technical leadership, scientific advancements and support for the capabilities development and system acquisition management processes. Activities of these organizations range from basic research to the correction of deficiencies in field systems. Academia and industry, as well as hands-on bench work contribute to the S&T mission. Technology insertion into systems is accomplished via the flow of patents, data, design criteria, and other information into TDs, Advanced Technology Demonstrations (ATD), JCTDs, new designs, and fielded systems.

e. Overall, the Army’s S&T strategy and programs are committed to the maintenance of technological superiority, while preserving the flexibility to cope with a wide array of possible threat, technology, and budget environments. The Army’s investment in S&T is paramount and is playing a greater role in acquisition than ever.

f. S&T activities aid TRADOC’s Army Capabilities Integration Center (ARCIC) and the Centers of Excellence (CoE), to better understand the “art of the possible” and refine the many requirements associated with them.

g. As with some concepts, S&T research occasionally produces an item that is recognizable as a defined requirement that should be documented and resourced. Most S&T products must be evaluated in warfighting experiments before a decision is made to document them as materiel requirements.

h. Oversight of the S&T program is provided by the Army Science and Technology Advisory Group (ASTAG), which is co-chaired by the Army Acquisition Executive (AAE) and the Vice Chief of Staff Army (VCSA). The Army Science and Technology Working Group (ASTWG), is co-chaired by the Army S&T executive (the Deputy Assistant Secretary of the Army for Research and Technology), and the Headquarters, Department of the Army (HQDA) Deputy Chief of Staff (DCS), G-8 Director, Force Development. The ASTWG provides the following: general-officer-level resolution of pressing S&T issues prior to meetings of the ASTAG; recommendations for ASTAG revisions to the Army’s S&T vision, strategy, principles, and priorities.

### 10-22. Army Technology Transition Strategy

The basic strategy of the S&T program is to transition mature technologies into operational systems that satisfy validated warfighting capabilities-based materiel requirements. The key to this strategy is demonstrations. TDs, ATDs, and JCTDs exploit technologies derived from applied research (6.2), which in turn build on new knowledge derived from basic research (6.1) programs. These TDs, ATDs, and JCTDs provide the basis for new systems, system upgrades, or advanced concepts which are further out in time.

a. Technology Maturity. Technology maturity measures the degree to which proposed critical technologies meet program objectives. Technology maturity is a principal element of program risk. A Technology Readiness Assessment (TRA) examines program concepts, technology requirements, and demonstrated technology capabilities to determine technological maturity.

(1) TRAs for critical technologies occur prior to Defense Acquisition System (DAS) Milestone Decision Review (MDR) MS B and C to provide useful technology maturity information to the acquisition review process.



## CAPABILITY REQUIREMENTS AND MATERIEL SYSTEM RESEARCH, DEVELOPMENT, AND ACQUISITION MANAGEMENT

(2) The Deputy Assistant Secretary of the Army (Research and Technology) (DASA(R&T)), directs the TRAs and for Major Defense Acquisition Programs (MDAP), submits the findings to the AAE, who submits the report to the Deputy Under Secretary of Defense for Science and Technology DUSD(S&T) with a recommended Technology Readiness Level (TRL) for each critical technology. In cooperation with the DASA(R&T), the DUSD(S&T) evaluates the TRAs and, after concurrence, forwards the findings to the DOD Overarching Integrated Product Team (OIPT) leader and the Defense Acquisition Board (DAB). If the DUSD(S&T) does not concur with the TRA findings, an independent TRA, under the direction of the DUSD(S&T), will be required.

(3) Technology Readiness Levels (TRLs) are a measure of technical maturity that enables consistent, uniform, discussions of technical maturity, across different types of technologies. Decision authorities must consider the recommended TRLs when assessing program risk. TRL descriptions appear in the Defense Acquisition Guidebook (see Fig. 10-16).

### Technology Readiness Levels

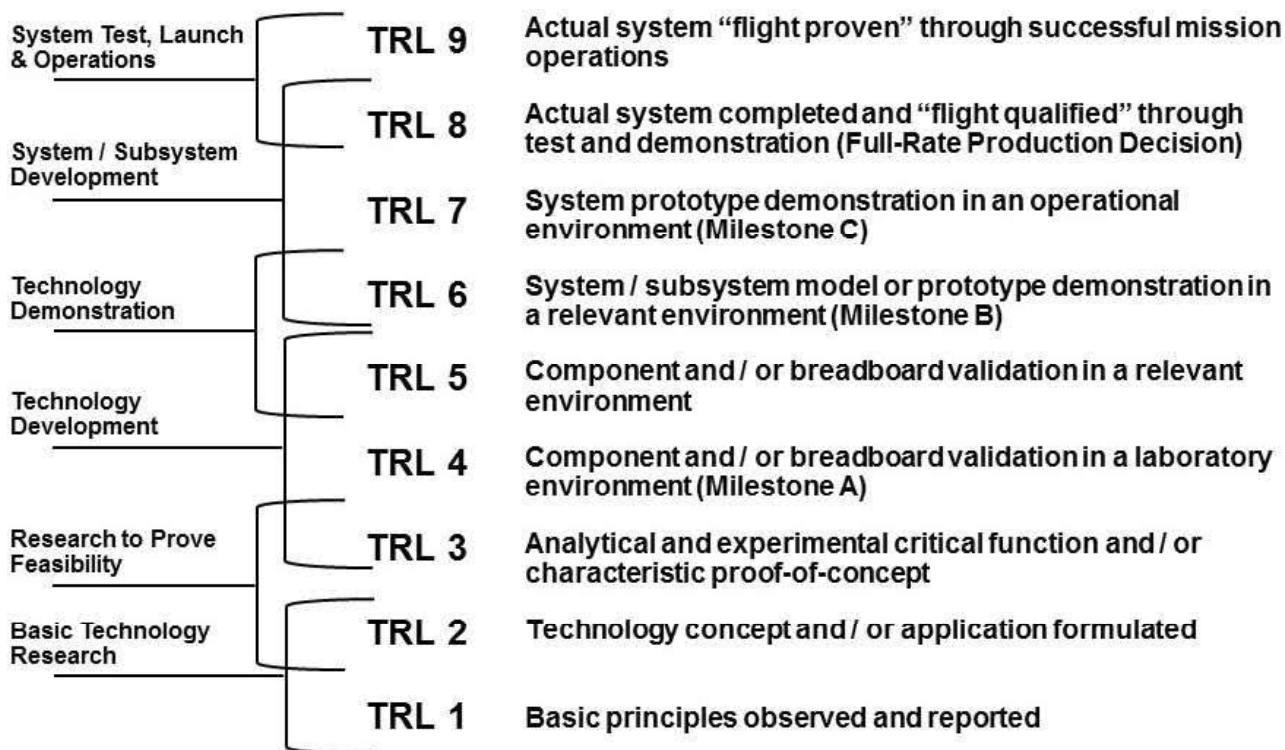

**Public Law Requires TRL 6 for ACAT 1 at Milestone B**

**Figure 10-16. Technology Readiness Levels**

b. Technology Demonstrations (TD). The primary focus of TDs is to demonstrate the feasibility and practicality of a technology for solving specific military requirements. They are incorporated during the various stages of the 6.2 and 6.3 development process and encourage technical competition. They are most often conducted in a non-operational (laboratory or field) environment. These demonstrations provide information that reduces uncertainties and subsequent engineering cost, while simultaneously providing valuable development and requirements data.

c. Advanced Technology Demonstrations (ATD). ATDs are typically integrated demonstrations that are conducted to demonstrate the feasibility and maturity of an emerging technology. They provide a relatively low-cost approach for assessment of technical risks and uncertainties associated with critical technologies prior to the incorporation of these technologies into a system entering the formal acquisition process. They are conducted at the Service and DOD agency level with internal funding. They focus on evolving a specific element of technology nominally at the 6.3 advanced technology development point (typically TRL 5-6) to reduce its risk of implementation by an acquisition program or to feed into a JCTD.

d. Joint Capability Technology Demonstrations (JCTD). DOD initiated the JCTD process to permit the early and relatively inexpensive evaluation of mature advanced technologies. The Soldier evaluates JCTDs to determine military utility of the technologies and to develop the Concept of Operations (CONOPS) that will optimize effectiveness. JCTDs are structured and executed so that, when successful, DOD can proceed rapidly into formal acquisition systems.

(1) By introducing new technologies in the field prior to the initiation of formal systems acquisition, DOD allows operators, who have experience in combat, to evaluate and assess the military utility and develop the tactics to ensure that we can realize the full potential of the substantial technology base that is available—both DOD and commercial. JCTDs are not a means by which to circumvent the formal acquisition process, but rather a means to enter that process based on a user assessment of the value of the new capability that reduces the user acceptance risk. This process helps DOD make more informed acquisition decisions and improve its acquisition cycle time.

(2) JCTDs are user oriented and represent an integrated effort to assemble and demonstrate a significant, new, or improved military capability based on mature advanced technologies. Also, they are on a scale large enough to demonstrate operational utility and end-to-end system integrity. As key participants, the operational user and materiel development communities jointly develop and implement a demonstration. JCTDs allow the Soldier to:

- (a) Evaluate a technology's military utility before commitment to a major acquisition effort
- (b) Develop CONOPS for employing the new technology
- (c) Retain a low-cost, residual operational capability, if desired
- (3) When a JCTD has been completed:

(a) Based on demonstrated military utility, execute the transition of the successfully demonstrated technology directly to the Soldier making only necessary minor, or perhaps no modifications to the existing hardware or software. This transition approach is particularly appropriate where Soldiers require only small quantities of the new equipment.

(b) Based on demonstrated military utility, enter the formal DAS at the appropriate MS B or C as per the appropriate Materiel Development Decision (MDD).

(c) Terminate the efforts or restructure them based on the evolved CONOPS and lessons learned during the JCTD.

(4) JCTDs can be proposed by DOD research and development agencies, the Joint Staff, CCDRs, military services, and industry. Some JCTDs are completed in less than one year and evaluate a very specific technology or address a particular mission area; others are several years long and include coordination of multiple developing technology programs into a series of specific demonstrations. The goal is to complete a JCTD within a 1 to 3 year period.

e. Systems and System Upgrades.

(1) The development of the next set of materiel systems requires prior demonstration of the feasibility of employing new technologies. Generally, these systems can enter the DAS Engineering & Manufacturing Development (EMD) phase relatively quickly as a result of the successful demonstration of enabling technologies.

(2) The Army is pursuing incremental improvements to existing systems to maintain its technological edge. These improvements are designated as systems modifications. System modifications are brought about through technology insertion programs, Service Life Extension Programs (SLEP), Preplanned Product Improvements (P3I), and block improvement programs.

f. In the broad sense, the event-driven materiel DAS consists of a series of management decisions made within DOD or the Services as the development of a materiel system progresses from a stated materiel requirement to a fielded system. Product Improvements (PI) to existing systems or acquisition of Non-Developmental Items (NDI) usually occur through acquisition streamlining. A key aspect of the process is that it is divided into five phases (materiel solution analysis, technology maturation & risk reduction, engineering and manufacturing development, production and deployment, and operations and

# CAPABILITY REQUIREMENTS AND MATERIEL SYSTEM RESEARCH, DEVELOPMENT, AND ACQUISITION MANAGEMENT

support); and other efforts such as LRIP; Full-Rate Production (FRP); and deployment, sustainment, and disposal). Entry into the DAS is at one of the formal MS decision points, dependent on the MDD.

g. Key policies and principles governing the operation of the DAS are (DODD 5000.01):

(1) Flexibility. There is no one best way to structure an acquisition program to accomplish the objective of the DAS. Milestone Decision Authorities (MDA) and PMs tailor program strategies and oversight, including documentation of program information, acquisition phases, the timing and scope of decision reviews, and decision levels, to fit the particular conditions of that program, consistent with applicable laws and regulations and the time-sensitivity of the capability need.

(2) Responsiveness. Mature technology is integrated into producible systems and deployed in the shortest time. Validated, time-phased capability needs matched with available technology and resources enable evolutionary acquisition strategies. Evolutionary acquisition is the Army approach to satisfying operational needs.

(3) Innovation. Throughout DOD, acquisition professionals continuously develop and implement initiatives to streamline and improve the DAS. MDAs and PMs examine and, as appropriate, adopt innovative practices (including best commercial practices), that reduce life-cycle time and cost, and encourage teamwork.

(4) Discipline. PMs manage programs consistent with statutory and regulatory requirements. Every PM establishes program goals for the minimum number of cost, schedule, and performance parameters that describe the program over its life-cycle. Approved APB parameters serve as program control objectives. PMs identify deviations from approved APB parameters and exit criteria.

(5) Streamlined and effective management. The MDA provides authority to accomplish MDA approved program objectives for development, production, and sustainment. The MDA ensures accountability and maximizes credibility in cost, schedule, and performance reporting.

h. Technology projects (e.g., JCTDs, Joint Warfighting Experiments (JWE), concepts development, and capabilities development), are efforts that occur prior to acquisition program initiation. These are referred to as pre-ACAT technology projects.

## 10-23. Acquisition Strategies and Program Plans

a. The Acquisition Strategy (AS) is the framework (roadmap) for planning, directing, and managing an acquisition program to satisfy a validated materiel requirement. Acquisition strategies and their supporting program plans are tailored to accomplish established program objectives and to control risk. Also, they must provide the information essential for MS decisions. In this regard, ASs are event-driven and explicitly link major contractual commitments and MS decisions to demonstrated accomplishments in development and testing.

b. Evolutionary acquisition. Evolutionary acquisition is the Army's preferred strategy for rapid acquisition of a mature technology for the user. An evolutionary approach delivers capability in increments recognizing, up front, the need for future capability improvements. The success of the strategy depends on the consistent and continuous definition of capabilities-based requirements and the maturation of technologies that lead to disciplined development and production of systems that provide increasing capability towards a materiel concept.

c. Program plans provide for a systems engineering approach to the simultaneous design of the product and its associated manufacturing, test, and support processes. This concurrent engineering approach is essential to achieving a careful balance among system design requirements (e.g., operational performance, producibility, reliability, maintainability, logistics and human factors engineering, safety, survivability, interoperability, and standardization).

## Section VIII

### Department of Defense Acquisition Organization and Management

## 10-24. Department of Defense System Acquisition Management

a. The USD(AT&L), is the senior procurement executive and the principal staff assistant and adviser to the SECDEF and takes precedence in DOD for all matters relating to the DAS: research and development; test and evaluation; production; logistics; command, control, and communications, and intelligence activities related to acquisition; military construction; and procurement.

## HOW THE ARMY RUNS

b. The USD(AT&L) serves as the Defense Acquisition Executive (DAE) with responsibility for supervising the performance of the entire DAS in accordance with the laws, Congressional guidance and direction. The DAE establishes policy for all elements of DOD for acquisition. The basic policies of the DAE are established and implemented by DODD 5000.01 and DODI 5000.02. The DAE serves as the chairman of the DAB, assisted by the OIPTs that relate to the acquisition process. As the DAB chairman, the DAE recommends to the SECDEF acquisition resource matters and other acquisition management matters required to implement acquisition MS decisions.

c. The Fiscal Year (FY) 2017 National Defense Authorization Act (NDAA) (Public Law 114-328) contains a provision (Sec. 901) that amends chapter 4 of title 10, United States Code, to establish an Under Secretary of Defense (Research and Engineering) (USD(R&E)), an Under Secretary of Defense (Acquisition and Sustainment) (USD(A&S)), and a Chief Management Officer (CMO) within the Department of Defense (DOD), effective on February 1, 2018. Section 901 also makes other modifying and conforming changes, and requires the Secretary of Defense to conduct a review and submit a series of reports to the congressional defense committees on the organizational and management structure of the Department.

### **10-25. Defense Advanced Research Projects Agency**

DARPA is a unique organization that consists of a mix of military and civilian scientists and engineers, and has a broad charter to conduct advanced research that fills R&D gaps between Service lines of responsibility or handles high priority problems that cross Service lines. DARPA's purpose is to review ongoing R&D, determine whether or not the concept is feasible, determine its usefulness, and transfer it to the appropriate Service.

### **10-26. Defense Acquisition University**

The DAU is a DOD training establishment authorized by Congress under the Defense Acquisition Workforce Improvement Act of 1990 and established by DOD Directive 5000.57 on October 22, 1991, that trains military and civilian personnel in the fields of acquisition, technology, and logistics. DAU provides that global learning environment to develop qualified acquisition, requirements, and contingency professionals who deliver and sustain effective and affordable warfighting capabilities enabling the defense acquisition workforce to achieve better acquisition outcomes.

## **Section IX**

### **Army Acquisition Materiel Development, Oversight, and Management**

#### **10-27. Army Research, Development, and Acquisition Goals**

a. The SECARMY is responsible for functions necessary for the research, development, logistical support and maintenance, preparedness, operation, and effectiveness of the Army. The SECARMY supervises all matters relating to Army procurement. The SECARMY executes his acquisition management responsibilities through the AAE.

b. Special emphasis is placed on medium and long-range materiel planning, product modification, and life extension programs. Stability of materiel acquisition programs is a matter of utmost interest, especially after the system passes the DAS MS B program initiation decision. Reliability, Availability, and Maintainability (RAM) goals; Human Systems Integration (HSI); Integrated Product Support (IPS); survivability; effectiveness; safety; and product quality are incorporated into system performance objectives.

#### **10-28. Army Acquisition Executive**

The Assistant Secretary of the Army (Acquisition, Logistics, and Technology) (ASA(ALT)) is the AAE. The AAE is designated by the SECARMY as the Component Acquisition Executive (CAE) and the senior procurement executive within HQDA. The AAE is the principal HQDA staff official for the execution of the AAE responsibilities. When serving as the AAE, the ASA(ALT) is assisted by a Principal MILDEP.

a. The MILDEP is assigned to the Office of the ASA(ALT) and provides staff support to the AAE in managing the R&D, Developmental Test (DT), and materiel acquisition for all Army weapon and support systems. The MILDEP, delegated down from the AAE, is also the Army Director, Acquisition Career Management (DACM). The DACM is responsible for directing the Army Acquisition Corps (AAC), as well

as implementation of the acquisition career management requirements set forth in the DAWIA legislation. The day-to-day management of Army acquisition programs is shown in Figure 10-17.

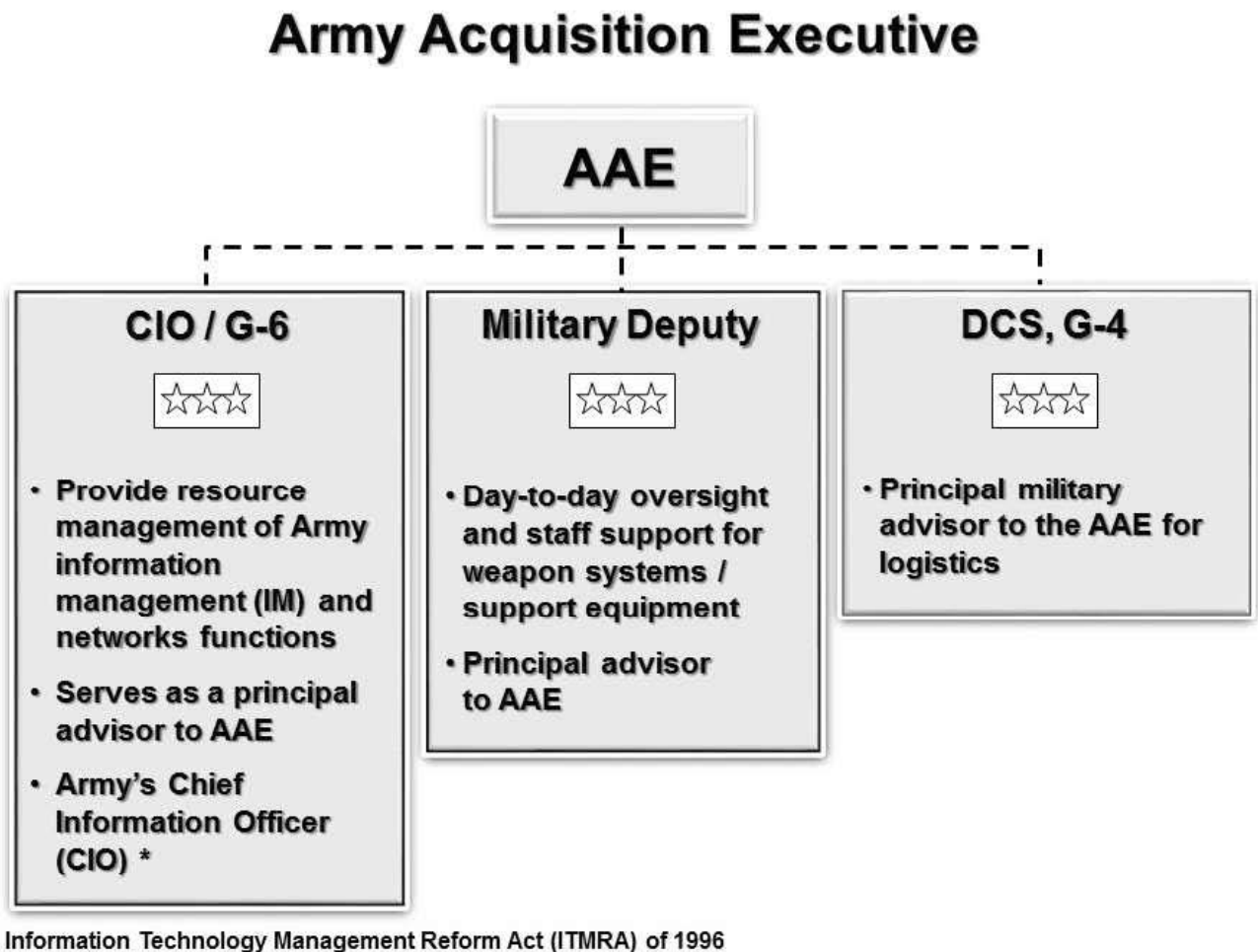

**Figure 10-17. Army Acquisition Executive**

b. The AAE develops Army acquisition policies and procedures and manages the Army's production base support and industrial mobilization programs. The AAE, acting with the full authority of the SECARMY, is responsible for administering acquisition programs according to DOD policies and guidelines, and exercises the powers and discharges the responsibilities as set forth in DODD 5000.01 for CAEs. In addition, the AAE:

- (1) Appoints, manages, and evaluates Program Executive Officers (PEO) and direct-reporting PMs.
- (2) Coordinates to establish policy and guidance for the AoAs for ACAT I and II programs; designates the organization responsible for performing system engineering trades analyses for the AoA; and provides issues and alternatives for inclusion in the AoA tasking document.
- (3) Carries out all powers, functions, and duties of the SECARMY with respect to the acquisition work force within the Army, subject to the authority, direction, and control of the SECARMY.
- (4) Develops guidance for the Army's Research, Development, and Acquisition Plan (RDAP).
- (5) Formulates Army-wide S&T base strategy, policy, guidance, and planning.
- (6) Establishes and validates Army technology base priorities throughout the PPBE process.

## HOW THE ARMY RUNS

(7) Acts as the final authority of all matters affecting the Army's acquisition system, except as limited by statute or higher-level regulation. Develops and promulgates acquisition, procurement, and contracting policies and procedures.

(8) Chairs all Army System Acquisition Review Council (ASARC) meetings.

(9) Directs the Army Science Board (ASB).

(10) Appoints the Source Selection Authority (SSA) for specified programs. The Federal Acquisition Regulation (FAR) is the primary contracting regulation. It is the first regulatory source to which DA acquisition personnel refer. The ASA(ALT) issues the Army Federal Acquisition Regulation Supplement (AFARS) to implement and supplement the FAR and the Defense Federal Acquisition Regulation Supplement (DFARS) and to establish uniform policies and procedures for use in the Army.

(11) Reviews and approves, for ACAT ID programs, the Army position at each decision MS before the DAB review. This includes the review and approval of APBs. The AAE serves as the Milestone Decision Authority (MDA) for ACATs IC, selected ACAT II programs, and assigns the MDA for ACAT III programs to the PEOs. The MDA is the individual designated to approve entry into the next acquisition phase.

(12) Approves the establishment and termination of all Program Management Offices (PMO) and PEOs. The AAE has authority to designate a system for intensive, centralized management and prescribe the appropriate level of management at any point in the program management process.

c. HQDA System Coordinator (DASC). The DASC is the primary acquisition staff officer at HQDA. The DASC is responsible for the day-to-day support of assigned programs and serves as the PM's representative and primary Point of Contact (POC) within the Pentagon. The DASC reports to the ASA(ALT), Deputy for Acquisition and Systems Management. The DASC is responsible for keeping the acquisition chain of command informed of the status of assigned acquisition programs. In addition, the DASC assists the PM with issue resolution at HQDA and OSD levels. The DASC is the "eyes and ears" of the PM at the Pentagon and ensures that the PM is advised of any actions or circumstances that might negatively impact their program.

### 10-29. Program Executive Officer

a. The PEO system structure was implemented by the Army in 1987, in response to requirements established by the Goldwater-Nichols Reorganization Act of 1986; and the recommendation of the Packard Commission, under President Reagan, that was approved and then ordered by the National Security Decision Directive (NSDD) 219 (see Fig 10-18).

b. The PEO, administering a defined number of AAE assigned MDAPs, major and/or non-major programs, is responsible for programmatics (materiel acquisition cost, schedule, and total system performance) and for the PPBE necessary to guide assigned programs through each DAS MS. In addition, the PEO provides program information to the AAE, HQDA, DOD, and Congress; defends assigned programs to Congress through the Army Office Chief of Legislative Liaison (OCLL); and participates in the development of data to support AAE programmatic decisions in the PPBE. Other PEO and direct-reporting PM responsibilities include assisting the CAPDEV and TNGDEV in developing capability requirements documents, by providing technical, availability, performance, anticipated materiel acquisition cost, and schedule type information as required.

c. The AAE has 12 PEOs—Missiles and Space; Aviation; Command, Control, Communications – Tactical; Intelligence, Electronic Warfare (EW) and Sensors; Ground Combat Systems; Combat Support/Combat Service Support Systems; Simulation, Training, and Instrumentation; Assembled Chemical Weapons Alternatives Program; Ammunition; Soldier; Enterprise Information Systems, and JPEO, Chemical and Biological Defense – responsible for the intensive management of RDA weapon and information systems. Unless a waiver is granted by the DAE or AAE, a PEO must be certified in acquisition management.

d. The Army's primary Capability Developer (CAPDEV) is the U.S. Army TRADOC. TRADOC formulates and documents operational concepts, doctrine, organizations, and/or materiel requirements for assigned Army functions. TRADOC serves as the user representative during acquisitions for their validated materiel requirements, as well as doctrine and organization developments.

e. A Materiel Developer (MATDEV) is located within the RDA command, agency, or office, assigned responsibility for the system under development or being acquired. The term may be used generically to refer to the RDA community in the materiel acquisition process (counterpart to the generic use of CAPDEV).

Packard  
Commission

## DOD Acquisition Authority Chain

NSDD  
#219  
1 Apr 86

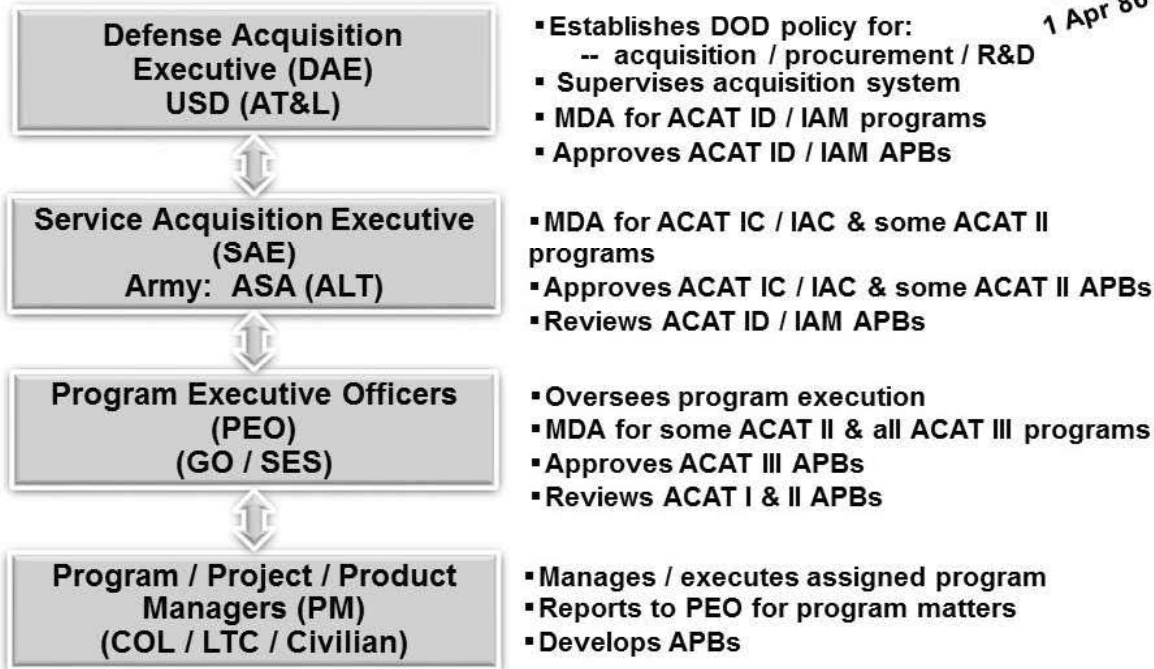

ACAT: Acquisition Category  
 APB: Acquisition Program Baseline  
 ASA (ALT): Assistant Secretary of the Army (Acquisition, Logistics, and Technology)  
 MDA: Milestone Decision Authority

NSDD: National Security Decision Directive  
 R&D: Research & Development  
 USD (AT&L): Under Secretary of Defense (Acquisition, Technology, and Logistics)

**Figure 10-18. Department of Defense Acquisition Authority Chain**

f. A Training Developer (TNGDEV) is located within a command or agency that formulates, develops, and documents or produces training concepts, strategies, requirements (materiel and other), and programs for assigned mission areas and functions. The TNGDEV serves as user (trainer and trainee) representative during acquisitions of their validated training materiel requirements and training program developments. TNGDEVs perform the following functions solely in support of training systems:

- (1) Fund and conduct concept formulations for all system Training Aids, Devices, Simulations, and Simulators (TADSS) in support of assigned systems
- (2) Integrate system training capabilities into assigned materiel systems in accordance with the validated system capability requirements documents and in coordination with the CAPDEV
- (3) Develop, acquire, and field the subsystem training package with the materiel system; plan and program resources for the execution of New Equipment Training (NET) using Distance Learning (DL) technology and/or contract NET as the desired training strategy in support of TRADOC developed/approved System Training Plans (STRAP).

### 10-30. Program / Project / Product Manager

a. The PM has authority and responsibility for all programmatic (cost, schedule, performance, and life-cycle sustainment) decisions to execute the assigned program within the approved APB and subject to functional standards established by regulation, secretarial direction, or law. Generically, all PMs are program managers, but they are chartered as a program manager, a project manager, or product manager generally based on the value and importance (visibility) of the program they manage. The criteria established for designation of a program manager are generally the same as those which cause a system acquisition to be designated as a MDAP, major, or non-major program—high defense priority, high dollar value, or major Congressional or OSD interest. Since 2001, all Army acquisition programs,

## HOW THE ARMY RUNS

regardless of ACAT, are managed by a PM, overseen by a PEO or directly reporting to the AAE. All PEOs report directly to the Defense Acquisition Executive (ACAT ID programs) or to the CAE (for ACAT IC and below). Project managers report to a PEO or the AAE. All product managers report to a project manager. This distinction between PMs is unique to the Army, and does not apply to the other Services.

b. The PM must be certified in acquisition unless a waiver is granted by the DAE or AAE management.

### 10-31. Headquarters, Department of the Army Oversight / Participants

a. The Chief of Staff of the Army (CSA). The CSA is responsible by law to the SECARMY for the efficiency of the Army and its preparedness for military operations. The CSA acts as the agent of the SECARMY in carrying out the plans or recommendations submitted by the ARSTAF and approved by the SECARMY. The VCSA, supports the CSA by managing the day-to-day operations of the Army. The CSA/VCSA chairs the AROC and in the area of RDA, the VCSA co-chairs the ASARC.

b. Assistant Secretary of the Army (Financial Management and Comptroller) (ASA(FM&C)). The ASA(FM&C) has secretariat responsibility for all financial management activities and operations for appropriated funds. While the budget is in preparation, the ASA(FM&C) receives and consolidates procurement and RDT&E budget forms from Army commands and PEOs. The ASA(FM&C) also:

(1) Works with the AAE on all cost and Economic Analysis (EA) matters related to the acquisition process.

(2) Carries out all financial management responsibilities assigned under Title 10.

(3) Tasks the appropriate MATDEV to conduct Program Office Estimates (POE) and/or EA to MDR and PPBE requirements.

(4) Manages all budgeting activities in support of the Army materiel requirements processes and RDA modernization program, with the framework of PPBE.

(5) Develops statutory Independent Life-Cycle Cost Estimates (ICE) and Component Cost Estimates (CCE) for weapon and information systems. Chairs and oversees the Army Cost Review Board (CRB) and approves the Army Cost Position (ACP) for all major acquisition programs. The ASA(FM&C) Deputy for Cost & Economics, ensures that the ACP reflects the costs and risks associated with the program.

c. Assistant Chief of Staff for Installation Management (ACSIM). The ACSIM is responsible for developing criteria for the mitigation of environmental impacts, and reviewing emerging Army RDA systems for environmental effects. The ACSIM is a regular member of the AR2B.

d. Deputy Chief of Staff, G-1 (DCS, G-1). The DCS, G-1 has ARSTAF responsibility for personnel management. DCS, G-1 monitors planning for the manpower and personnel aspects of new systems. The DCS, G-1 is the proponent and has primary ARSTAF responsibility for the Army Human Systems Integration (HSI) program. The emphasis of the HSI program is to enhance total system performance (Soldier in the loop) and to conserve the Army's Manpower, Personnel, and Training (MPT) resources. The DCS, G-1 is a regular member of the AROC, ASARC, and AR2B.

(1) The HQDA Personnel System Staff Officer (PERSSO) is the ARSTAF representative of the personnel community. The PERSSO provides for the continuous coordination necessary to ensure the smooth integration of new equipment, materiel systems, and new organizations. The PERSSO responsibilities include, but are not limited to: preparing and justifying force structure requests in conjunction with the DCS, G-3/5/7 Organization Integrator (OI) and DCS, G-8 SSO; reviewing and coordinating the development of force structure changes; personnel supportability architecture; officer and enlisted issues related to new organizational concepts and doctrine; and ensuring programming and budgeting of manpower spaces.

(2) The PERSSO participates in all HQDA actions to develop the staff position on CAPDEV proposals for potential MDAPs, the designation of a proposed system, the recommendations on the elements of system fielding, including the proposed BOIP, the Initial Issue Quantity (IIQ), and the Army Acquisition Objective (AAO). The PERSSO represents the DCS, G-1 at force modernization-related, HQDA-sponsored conferences, forums, and meetings on issues of supportability concerning the introduction of new and/or reorganized existing table of organization and equipment (TOE)/ TDA units.

e. Deputy Chief of Staff, G-2 (DCS, G-2). The DCS, G-2 provides scientific and technical intelligence and threat projections in support of all aspects of the Army RDA programs. The DCS, G-2 is a regular member of the ASARC, AROC, and AR2B. In addition, a HQDA Threat Integration Staff Officer (TISO) is designated by the DCS, G-2 to function as the HQDA threat integration coordinator for designated mission areas, programs, and systems. The TISO represents the DCS, G-2 on all aspects of threat support throughout the system life-cycle or study process. The TISO complements the DCS, G-8 RSO



## CAPABILITY REQUIREMENTS AND MATERIEL SYSTEM RESEARCH, DEVELOPMENT, AND ACQUISITION MANAGEMENT

and SSO and is designed to foster closer coordination among the intelligence community, Army commands, and ARSTAF agencies to ensure the timely integration of the threat into the materiel acquisition process.

f. Deputy Chief of Staff, G-3/5/7 (DCS, G-3/5/7). As the Army's force manager, the DCS, G-3/5/7 serves as the HQDA proponent for all Army force structure related policies, processes, and actions. The DCS, G-3/5/7 is a regular member of the ASARC, AROC, and chairs the AR2B. The DCS, G-3/5/7:

- (1) Integrates Army DOTMLPF-P capability-based requirements into structure;
- (2) Develops and maintains force planning guidance and active and reserve component force structure through the Total Army Analysis (TAA) force accounting, force documentation and other force management forums; and
- (3) Oversees the force management, training, and mission command prioritization processes for the Army; Army policies and procedures for execution of the JCIDS UON process
- (4) Provides support for equipment/system capability and employment issues, including: the DAS process (ASARC / OIPT / DAB); PPBE (POM / investment reviews with HQDA DCS, G-8); and Congressional inquiries and testimony.
  - (a) Conducts staff integration of ONSs for urgently required warfighting capabilities, to include: serves as the HQDA lead for ONS requests submitted by operational commanders; and develops validation recommendations/conduct execution planning for HQDA DCS, G-3/5/7 in support of overseas contingency operations missions.
  - (b) Responsible for integrated validation recommendations to the HQDA DCS, G-3/5/7 on urgent warfighting requirements (ONSs)
  - (c) Prepare congressional correspondence and testimony addressing operational requirements and future warfighting capabilities
  - (d) Provide PPBE support to the Budget, Requirements and Programs (BRP) Board regarding operational requirements and integration considerations for Army Programs.
  - (e) Responsible for HQDA staffing of other Service capability documents
  - (f) Produce official Army Position on Army and other Service capability documents during joint staffing
  - (g) Responsible for HQDA staffing of Army capability documents, including comment resolution, in support of AROC validation decisions

(5) Deputy Chief of Staff, G-37 (Director, Force Management). USAFMSA and G-37/FM Ols/FIs role in assisting TRADOC force modernization proponents and other force modernization proponents with the development of Army Acquisition Objective (AAO) BOIG and participating in the proponents' world-wide staffing of capability documents:

USAFMSA: Provide insight into the development of AAO BOIG with focus on alignment with USAFMSA BOIP. Review and verify that the BOIG is written to facilitate specific guidance needed for BOIPFD and subsequent documentation. G-37/FM Ols/FIs: Ensure basis of issue guidance is consistent with the programmed structure and doctrine; and conduct quality control of proponents' estimated AAO for accuracy. USAFMSA and G-37/FM Ols/FIs: Review the draft capability documents along with the AAO-BOIG during the proponents' world-wide staffing to ensure completeness of the AAO-BOIG before the TRADOC requirements validation phase. DAMO-FM's role in staffing and providing a position on JCIDS capability documents via CAMS during HQDA staffing phase of the AROC process. DAMO-FM Ols and select FIs will register for a CAMS account.

g. Deputy Chief of Staff, G-4 (DCS, G-4). The DCS, G-4 assesses the logistical supportability of materiel systems during the DAS process. The DCS, G-4 participates in all phases of the RDA management process to ensure equipment is logistically reliable, supportable, and maintainable. The DCS, G-4 is a regular member of the ASARC, AROC and AR2B. The DCS, G-4 has been designated the Principal Military Advisor to the AAE for logistics.

h. Chief Information Officer (CIO)/G-6: The CIO/G-6, as directed by the Clinger-Cohen Act (Known as the Information Technology Management Reform Act (ITMRA) of 1996, has responsibility for the management of resources for all Army information programs and is a regular member of the ASARC, AROC, and the AR2B.

i. Deputy Chief of Staff, G-8 (DCS, G-8) a) Serves as the Proponent for the Army's warfighting capabilities (requirements) determination policy (AR 71-9) and manages: Army implementation of JCIDS; DCS G-8 is the proponent for policy development and joint/Army JCIDS process oversight.

## HOW THE ARMY RUNS

(1) Within the DCS, G-8, the RSO is directly responsible for leading HQDA staff integration and coordination efforts for all Army and joint DOTMLPF-P requirements issues within the JCIDS process for the Army. The RSO coordinates with the SSO, to facilitate the transition from requirements development and validation to requirements solutions (execution and resourcing). The DCS, G-8 is the single entry point, as the Army's JCIDS "gatekeeper," for all Army and joint DOTMLPF-P requirements. DCS G-8 validates current and future Army warfighting capability requirements. The DCS, G-8 prepares the Army POM; integrates and synchronizes the POM process; and provides analysis and evaluation of Army programs to the senior Army leadership. Serves as the HQDA Gatekeeper for JCIDS documents to support HQDA validation of TRADOC-generated documents by the AROC; development of the official Army position on other Service/COCOM documents during joint staffing; configuration management of Army documents during joint staffing and JROC review for validation; and AROC secretariat support. DCS, G-8 is a regular member of the ASARC, AROC, Army Marine Corps Board (AMCB), and the AR2B. The DCS, G-8 responsibilities also include staff integration of modernization proposals to support force development planning; execute JCIDS document staffing within ARSTAF/lead comment resolution process; organize presentation of Army modernization proposals to AROC for validation; assemble Army position/input on other Service JCIDS documents during joint staffing; and support joint review of Army proposals/input during FCB consideration.

(2) Army program advocate to OSD, the JS, other military departments, government agencies and organizations.

(3) Overseeing materiel fielding across the Army and ensuring integration of DOTMLPF-P into materiel solutions (IAW validated Army requirements).

(4) Serving as principal advisor to the CSA on joint materiel requirements, representing the Army in the JS FCB, JCB, and JROC process.

(k) G-8, Director, Program Analysis and Evaluation (D, PA&E). Within DCS, G-8, the DPAE is responsible for reviewing and analyzing requirements and programs in force structure development; providing analytical support; developing resource guidance; developing and compiling the POM; maintaining the Army portion of the DOD Future Years Defense Program (FYDP); and presenting an affordability analysis to the ASARC. Other responsibilities include conducting and presenting affordability assessments to support DOD and HQDA ACAT I programs, and managing the programming phase of the PPBE process.

I. G-8, Director, Force Development (FD). Within DCS G-8, the Director, FD translates validated Army DOTMLPF-P requirements into programs, within allocated resources, to accomplish Army missions and functions. In addition, the Director, FD exercises life-cycle management of materiel programs. The FD Directorate is organized with a Director of Materiel (DOM), Director of Joint & Integration (DJI), and Director of Resources (DOR).

(1) Within the FD Directorate, the RSOs/SSOs focus on systems and fielding to deliver capabilities and functions to the warfighting force structure of the Army; and are the single ARSTAF POCs for integration and synchronization of all Army materiel programs to achieve the TAP priorities; also responsible for the integration, synchronization, and coordination of hardware, software, and associated equipment in support of the TAP.

(2) RSOs/SSOs—

(a) Coordinate with TRADOC Capability Managers (TCM) and HQDA G-37 (OIs) during the requirements phase on affordability and TAA/Force Feasibility Reviews (FFR) resourcing.

(b) Program money to support materiel programs and insertion into the Army in the POM years in the Force Development Investment Information System (FDIIS), where FDIIS is the primary planning, programming, and budgeting decision support tool to insert data into the POM.

(c) Work with ASA(ALT) DASC and ASA(FM&C) budget liaison (SAFM-BUL), to influence current year and budget year of execution, where SAFM-BUL defends programs and the details of the President's Budget (PRESBUD) to the Congressional appropriations committees.

(d) Submit requests for overseas contingency operations funding.

(e) Work with HQDA G-37, ACOMS, and PMs to determine fielding plans IAW Army priorities.

(f) Analyze production and equipment on hand against requirements / authorizations.

(g) Develop solutions to problems incurred due to changes in funding requirement/authorization, schedule, or performance.

(h) Prepare justifications for defending current programmed money and funding Unfunded Requirements (UFR) to POM boards and other forums for resourcing and prioritization.

# CAPABILITY REQUIREMENTS AND MATERIEL SYSTEM RESEARCH, DEVELOPMENT, AND ACQUISITION MANAGEMENT

- (i) Coordinate with HQDA G-4 and AMC on life-cycle sustainment and disposition of materiel.

## 10-32. Army Commands / Major Subordinate Commands – Oversight / Participants

a. U.S. Army Materiel Command (AMC). AMC performs assigned materiel and related functions for logistics support of materiel systems, and other system acquisition management functions required by HQDA. AMC is a regular member of the AROC, ASARC and AR2B. The AMC mission, in support of RDA, is to:

- (1) Equip and sustain a trained, ready Army
- (2) Provide development and acquisition support to MATDEVs (PEOs and PMs)
- (3) Provide equipment and services to other nations through the Security Assistance Program
- (4) Define, develop, and acquire superior technologies
- (5) Maintain the mobilization capabilities necessary to support the Army in emergencies
- (6) Verify system safety; support developmental and operational tests; and participate in the continuous evaluation process
- (7) Exercise delegated authority, under ASA(ALT) oversight, in the following areas: metrication; design to cost; production readiness reviews; manufacturing technology standardization; reliability, availability, and maintainability; quality; risk management; value engineering; parts control; and industrial modernization improvement
- (8) Provide survivability, vulnerability, or lethality assessments and survivability enhancement expertise for all Army materiel programs
- (9) Evaluate and recommend improvements to the industrial base
- (10) Maintain responsibility for the logistics support of assigned materiel in response to validated capabilities-based materiel requirements
- (11) Plan, coordinate, and provide functional support to PEOs and PMs. Support includes, but is not limited to, procurement and contracting, legal, managerial accounting, cost estimating, systems engineering, conducting system TADSS and embedded training concept formulation, developmental test, logistics support analyses, HSI, environmental, intelligence and threat support, configuration management, and conducting various independent assessments and analyses;
- (12) Provide overall management of the Army's technology base, including identification of maturing technologies necessary to support acquisition of warfighting materiel systems;
- (13) Provide RDA science and infrastructure information to HQDA for the Army RDAP; and
- (14) Provide initial and updated cost and system performance estimates for battlefield and peacetime operations as inputs to supporting analysis and program decisions

b. U.S. Army Training and Doctrine Command (TRADOC). TRADOC is the Army's primary "user representative" in the capabilities development and system acquisition management processes. As the Army's principal CAPDEV, TRADOC guides, coordinates, and integrates the total capabilities development effort of the Army. Capabilities developments are a major component of force development and encompass the formulation of concepts, doctrine, organization, materiel objectives, capabilities-based requirements, and OT for the Army's products for joint capabilities integration and development system (JCIDS). TRADOC is a regular member of the AROC, ASARC and the AR2B.

(1) As the Army's primary CAPDEV/TNGDEV, TRADOC is the Army's "Architect for the Future" and is charged to chart the future course for the Army. In doing so, CG, TRADOC:

(a) Guides and disciplines the Army's products for JCIDS by: providing capabilities-based requirements generation and documentation procedures and process guidance; generating all Army warfighting DOTMLPF-P requirements prior to their submission to HQDA for validation and resourcing; and coordinating capability requirements documents produced by the Army community and forwarded to HQDA DCS, G-8/FD for staffing, validation, and prioritization.

(b) Assists HQDA to prioritize and justify warfighting requirements by: determining applicability of current force ONSs to future Army-wide requirements and assign to a CoE/proponent for requirement documentation; providing insights and descriptive information for materiel programs; and supporting HQDA DCS G-8/FD, by presenting documents and information to the JCIDS Capabilities-Based Assessment process and assisting in issue resolution.

(c) Coordinates and integrates the total capabilities/training developments efforts of the Army by: providing, with appropriate support from other Army commands, the capstone and subordinate operating and functional warfighting concepts and FOCs; being the primary source for determining the need for and preparing capabilities-based requirements and capability requirements documents for TADSS and

## HOW THE ARMY RUNS

embedded training; and determining need for and obtain CSA approval for conduct of joint warfighting assessments (JWA).

(d) Conducts AoAs for ACAT I, and most ACAT II programs when required by HQDA. When required by the MDA, conducts AoA for all other ACAT programs.

(e) Provides representative to Army S&T reviews and management teams.

(2) TRADOC is organized into integrating centers and functional area CoEs and schools. The CoE Capabilities Development & Integration Directorates (CDID) work very closely with the PEO community in the RDA management process.

(3) Director, ARCIC:

(a) Determines and integrates force requirements and synchronizes the development of DOTMLPF-P solutions across the Army.

(b) Leads joint and Army CD&E efforts through TRADOC and non-TRADOC proponents.

(c) Leads the execution of the JCIDS process by TRADOC and/or non-TRADOC proponents to determine capability requirements for the force. Identifies joint and Army gaps and redundancies in capability; proposes DOTMLPF-P solutions to resolve or mitigate gaps; and recommends divestitures to help fund new requirements.

(d) Leads Asymmetric Warfare (AW) efforts within TRADOC. Integrates and synchronizes proponent activities within the AW areas of electronic warfare, protection, and improvised explosive device – defeat.

(e) Validates research and development priorities for Army S&T needs (to include special access programs (SAP)), for the required capabilities outlined in Army concepts ICW the ASA(ALT). Conducts a review of SAP and new S&T initiatives, as required, to ensure technology is aligned with future needs.

(f) Provides guidance for the execution of TRADOC force design goals and objectives and recommends approval to release organizational changes and adjustments for Army-wide staffing.

(g) Supports the CG, TRADOC in his role as the operational architect of the Army.

(h) Manages, coordinates, develops, and maintains the Battle Lab Collaborative Simulation Environment (BLCSE) federation of Modeling and Simulation (M&S), and distributed simulation network in support of joint and Army capabilities development and experimentation.

(i) Manages the M&S requirements for concept development and experimentation.

(j) The Director, ARCIC, through the CG TRADOC, is directly responsible to the SECARMY and CSA to ensure that technologies are transitioned into the current force as soon as they are ready.

(k) The ARCIC has a number of primary responsibilities to include the use wargaming, experimentation, and concepts to develop and integrate force capability requirements for the Army from a comprehensive perspective of DOTMLPF-P. They identify and integrate Army current and future force DOTMLPF-P requirements and synchronize the development of DOTMLPF-P solutions across the Army. They provide the management structure for identifying capability gaps and directing analytical support for DOTMLPF-P developments, including validating R&D priorities for key Army S&T needs, and the development and validation of integrated operational architectures depicting warfighting capabilities. ARCIC serves as the lead Army agency for coordination with joint agencies and other Services for identification and integration of joint RCs, including joint wargaming, concept development, and experimentation efforts.

(l) In support of these responsibilities, ARCIC is organized with major directorates: The Concept Development and Learning Directorate (CDLD) prioritizes, manages, and synchronizes TRADOC's efforts in joint and Army concept development and experimentation and creates and maintains operational concepts for the force. The Capabilities Development Directorate works on long-term and near term needs, analyzes concepts, and identifies tasks, capability gaps, and DOTMLPF-P solutions to achieve the concept driven RCs. The Force 2025 and Beyond Directorate ensures analysis and integration for the development of a leaner, more capable, and more expeditionary Army, where beyond 2025, the Army will be fundamentally changed, uniquely enabled, and organized to conduct expeditionary maneuvers of operationally significant forces to achieve campaign objectives and strategic goals. The Joint Modernization Command (JMC), stationed at FT Bliss Texas, is ARCIC's MTOE unit which is used to test equipment and concepts in a live training environment. Currently the JMC is involved in a test and evaluation of equipment Network Integrated Evaluation (NIE) and Joint Warfighting Assessment (JWA) efforts; and International Army Programs Directorate coordinates TRADOC activities with multinational partners across TRADOC CoEs.

(m) The TRADOC G-9 element acts as the liaison between TRADOC and the ARSTAF, JS, OSD, and others in the Washington DC area.

## CAPABILITY REQUIREMENTS AND MATERIEL SYSTEM RESEARCH, DEVELOPMENT, AND ACQUISITION MANAGEMENT

(4) Combined Arms Center (CAC). CAC provides the following: leadership and supervision for leader development and professional military and civilian education; institutional and collective training; functional training; training support; mission command; doctrine; and lessons learned. CAC also covers specified areas the CG, TRADOC designates in order to serve as a catalyst for change and to support developing relevant and ready expeditionary land formations with campaign qualities in support of the joint force commander.

(5) Combined Arms Support Command (CASCOM). CASCOM, the Sustainment CoE, has the mission to develop logistics leaders, doctrine, organizations, training, and materiel solutions. There are three major functions performed by CASCOM:

(a) Develops and evaluates sustainment warfighting function concepts, doctrine, organizations, systems, materiel concepts and requirements, and planning factors for the Army and in concert with joint logistics doctrine. CASCOM ensures the personnel service support, supply, maintenance, transportation, Services, and facilities systems designed for the Army in the field and the CONUS-based theater logistics systems, are compatible with the sustaining base system.

(b) Acts as the TRADOC proponent for CSS training and monitors and evaluates CSS training at TRADOC schools. CASCOM ensures CSS course content is consistent with approved doctrine and assesses the training evaluation process at associated schools.

(c) Serves as a principal adviser to HQDA, TRADOC, and AMC on all CSS matters. CASCOM provides direction, guidance, and tasks to assigned capabilities development activities, associated CoEs, other Army Commands, and HQDA staff agencies for their contribution to CSS development and training.

(6) CoE Capabilities Development and Integration Directorate (CDID). CDID represents the CoE in the execution of its responsibilities for concept development, experimentation, and requirements determination. CDID's purpose is to facilitate the development, assessment, management, validation, and synchronization of DOTMLPF-P-integrated combined arms capabilities that complement joint, interagency, and multinational capabilities. The CDID serves as the primary activity to develop proponent, Army and joint concepts; reviews Army and joint doctrine, support experimentation efforts, reviews requirements documentation, and reviews training material; assists in the development of training materials; and develops proponent equipment Operational Mode Summary/Mission Profiles (OMS/MP). The OMS/MP describes the anticipated missions; units (active, reserve, and institutional training base); or mix of units that will use the system overtime to include peacetime, crisis situations, national conflict, and war; in what environments and under what conditions (climate, terrain, battlefield environment, etc.), as well as how it will be supported and maintained.

(7) TRADOC Capability Manager (TCM). The TRADOC counterpart to the PM, the TCM, is a central figure in the RDA process and a key member of the MATDEV/ CAPDEV team. The TCM is TRADOC's focal point for coordination of the CAPDEV/TNGDEV efforts in the development and acquisition of a materiel and/or AIS capability. The TCM is responsible for synchronizing all DOTMLPF-P domains that are impacted by the fielding of major materiel capability. A TCM is associated with a capability solution early in the development cycle, normally at the same time as the PM. The TCM is located in the CDID at the CoE proponent center or school.

(8) Army Test and Evaluation Command (ATEC). The CG, ATEC is responsible for management of the Army's OT, DT, and System Evaluation (SE) processes. Their evaluations of materiel and IT systems' operational effectiveness, suitability and survivability are independent of the CAPDEV/MATDEV and are reported directly to the MDA. CG, ATEC is a member of the ASARC, AROC, and chairman of the Test Schedule and Review Committee (TSARC). The TSARC is the HQDA centralized management forum for user (operational) testing and resources. ATEC provides advice and assistance to the CSA, the VCSA, other members of the ARSTAF, and other elements of HQDA in regard to Army T&E. Other responsibilities include:

(a) Reviewing all draft capability requirements documents for T&E implications.

(b) Assisting TRADOC ARCIC in developing evaluable, operationally relevant, and totally system focused Critical Operational Issues and Criteria (COIC). Provide advice concerning methods and measures to evaluate the system against the COIC and advise on the resources and ability to test and evaluate the system.

(c) Preparing and approving all ATEC Capabilities & Limitations (C&L) Reports in support of rapid fielding.

(d) Supporting the TRADOC JWA program, Network Integration Evaluation (NIE) and Concept Experimentation Program (CEP).

(9) Other organizations. TRADOC serves as the Army's primary capabilities developer; however, there are other organizations that develop unique warfighting concepts and capabilities-based DOTMLPF-P requirements and forward to the TRADOC ARCIC for appropriate action such as: Corps of Engineers (USACE); Intelligence and Security Command (INSCOM); Medical Command (MEDCOM); Space and Missile Defense Command (SMDC); and Special Operations Command (USASOC).

### Section X

#### Operation of the Defense Acquisition System

##### 10-33. Department of Defense Instruction 5000.02 (7 January 2015)

DODI 5000.02 (incorporating Change 2, effective February 2, 2017), instructs the Milestone Decision Authority (MDA), the designated individual with overall responsibility for a program, to be accountable for cost, schedule, and performance reporting to higher authorities, to include Congress. This document authorizes the MDA to tailor the regulatory requirements and acquisition procedures in DODI 5000.02 to more efficiently achieve program objectives, consistent with statutory requirements. The instruction provides the detailed procedures that guide the operation of the system. Successful defense acquisition depends on careful thinking and sound professional judgments about the best acquisition strategy to use for a particular product. DODI 5000.02 contains several program structure models instead of the single model (previous model) that has been in effect since December 2008 timeframe. These models, are not alternatives from which a Program Manager must choose; they are examples and starting points that can and should be tailored to the actual product being acquired. MDAs have been given broad authority to tailor program acquisition strategies. The following Defense Acquisition Program Models are as follows: Model 1 (Hardware Intensive Program); Model 2, Defense Unique Software Intensive Program; Model 3, Incrementally Deployed Software Intensive Program; Model 4, Accelerated Acquisition Program; Model 5, Hybrid Program A (Hardware Dominant); and Model 6, Hybrid Program B (Software Dominant). DAS Models 1-6 are shown in Figures 10-19 through 10-24.

##### 10-34. Materiel Development Decision

a. The Materiel Development Decision is based on a validated initial requirements document (an ICD or equivalent requirements document) and the completion of the Analysis of Alternatives (AoA) Study Guidance and the AoA Study Plan. This decision directs execution of the AoA, and authorizes the DOD Component to conduct the Materiel Solution Analysis Phase. This decision point is the entry point into the acquisition process for all defense acquisition products; however, an "acquisition program" is not formally initiated (with the accompanying statutory requirements) until Milestone B, or at Milestone C for those programs that enter directly at Milestone C. DOD Components may have conducted enough analysis to support preliminary conclusions about the desired product at this point. If so, that analysis may be used by the MDA to narrow the range of alternatives. If not, requirements are likely to be less well-defined or firm, and a wider range of alternatives will need to be considered.

b. At the Materiel Development Decision, the DCAPE, (or DOD Component equivalent) will present the AoA Study Guidance, and the AoA lead organization will present the AoA Study Plan. In addition, the Component will provide the plan to staff and fund the actions that will precede the next decision point (usually Milestone A) including, where appropriate, competitive concept definition studies by industry.

(c) If the Materiel Development Decision is approved, the MDA will designate the lead DOD Component; determine the acquisition phase of entry; and identify the initial review milestone, usually, but not always, a specific milestone as described in one of the program models. MDA decisions will be documented in an ADM. The approved AoA Study Guidance and AoA Study Plan will be attached to the ADM.

##### 10-35. Materiel Development Decision Review

a. At the MDD review, the validated ICD is presented to the MDA. The ICD documents the need for non-materiel and/or materiel solution approaches to resolve a specific high risk capability gap derived from the JCIDS CBA process. The ICD includes: the preliminary CONOPS; a description of the needed capability; the operational risk; and the basis for determining that non-materiel approaches will not sufficiently mitigate the capability gap. The OSD Director, Assessment & Program Evaluation (D, CAPE), (or Service equivalent), proposes study guidance for the MS AoA. The purpose of the AoA is to assess the potential system-level materiel solutions to satisfy the selected materiel concept (approach)

# CAPABILITY REQUIREMENTS AND MATERIEL SYSTEM RESEARCH, DEVELOPMENT, AND ACQUISITION MANAGEMENT

documented in the validated ICD. The AoA identifies a best set of system attributes, that are both operationally effective and affordable, and provides the analytical basis for the CDD.

## Defense Acquisition System—2015 DODI 5000.02 (7 Jan 15) Model 1: Hardware Intensive Program

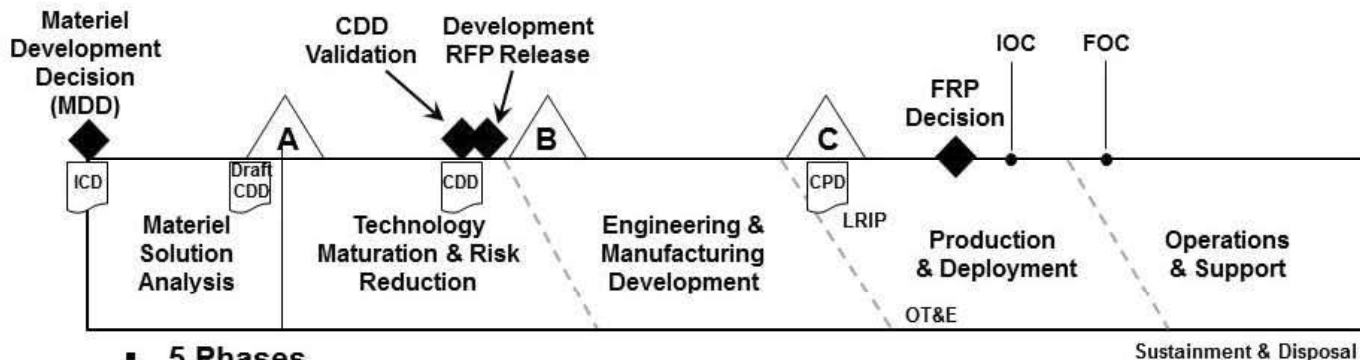

- 5 Phases
- 3 Milestone Decisions – A, B, C
- “Mandatory” Entry at Materiel Development Decision (MDD)
- 2 In-Phase Decisions – Development RFP Release Decision and Full-Rate Production / Full Deployment Decision

CDD: Capability Development Document  
 CPD: Capability Production Document  
 FOC: Full Operational Capability  
 FRP: Full Rate Production  
 ICD: Initial Capabilities Document  
 IOC: Initial Operational Capability  
 LRIP: Low Rate Initial Production  
 OT&E: Operational Test & Evaluation  
 RFP: Request for Proposal

**Figure 10-19. Defense Acquisition System, Model 1: Hardware Intensive Program**

b. The MDA designates the lead agency to refine the initial materiel concept selected, approves the AoA study guidance, and establishes a date for a MS A review. The MDA decisions are documented in an acquisition decision memorandum (ADM). This effort normally is funded only for the MSA work. The MDA decision to begin the MSA phase does not mean that a new acquisition program has been initiated.

c. Following approval of the study guidance, the organization conducting the AoA immediately prepares an AoA study plan to assess preliminary materiel solutions, identify key technologies, and estimate life-cycle costs. Following the MDD, the MDA may authorize entry into the DAS at any point consistent with phase-specific entrance criteria and statutory requirements. Progress through the DAS depends on obtaining sufficient knowledge to continue to the next phase of development. The MDD review is the formal entry point into the DAS and is mandatory for all potential acquisition programs. The MSA phase begins with the MDD review.

### 10-36. Materiel Solutions Analysis Phase

The purpose of this phase is to conduct the analysis and other activities needed to choose the concept for the product that will be acquired, to begin translating validated capability gaps into system-specific

requirements including the Key Performance Parameters (KPPs) and Key System Attributes (KSAs), and to conduct planning to support a decision on the acquisition strategy for the product. AoA solutions, key trades among cost, schedule, and performance, affordability analysis, risk analysis, and planning for risk mitigation are key activities in this phase.

## Model 2: Defense Unique Software Intensive Program

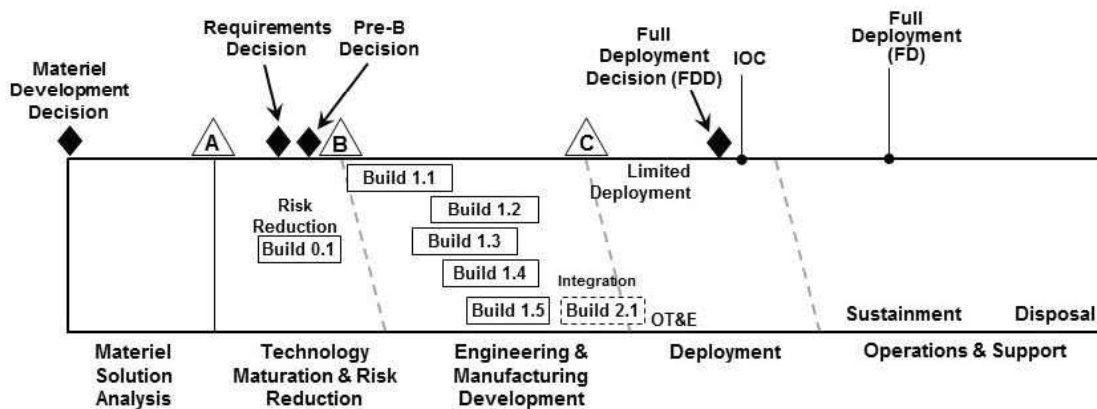

- **Complex, usually defense-unique, software program that will not be fielded until several software builds have been completed**
- **Examples: Command and control systems and significant upgrades to the combat systems found on major weapons systems such as surface combatants and tactical aircraft**
- **Several software builds must be developed and tested before deployment can proceed: first, individually; and then, as an integrated whole**

**Figure 10-20. Model 2: Defense Unique Software Intensive Program**

### 10-37. Milestone A

a. Minimum funding required for this phase is normally that needed to analyze and select an alternative for materiel development, and to complete the activities necessary to support a decision to proceed to the next phase; technology development and concept analysis and design efforts may also be funded in this phase.

b. The validated ICD and the AoA Study Plan will guide the AoA and Materiel Solution Analysis Phase activity. The analysis will be conducted in accordance with the procedures in Enclosure 9 of this instruction, and focus on identification and analysis of alternatives; measures of effectiveness; key trades between cost and capability; total life-cycle cost, including sustainment; schedule; concepts of operations; and overall risk. The AoA will inform and be informed by affordability analysis, cost analysis, sustainment considerations, early systems engineering analyses, threat projections, and market research.

c. Prior to the completion of this phase, the DOD Component combat developer will prepare a Concept of Operations/Operational Mode Summary/Mission Profile (CONOPS/OMS/MP) that will include the operational tasks, events, durations, frequency, operating conditions and environment in which the recommended materiel solution is to perform each mission and each phase of a mission. The CONOPS/OMS/MP will be provided to the Program Manager and will inform development of the plans for



the next phase including: acquisition strategy, test planning, and capability requirements trades. It will be provided to industry as an attachment for the next acquisition phase RFP.

## Model 3: Incrementally Deployed Software Intensive Program

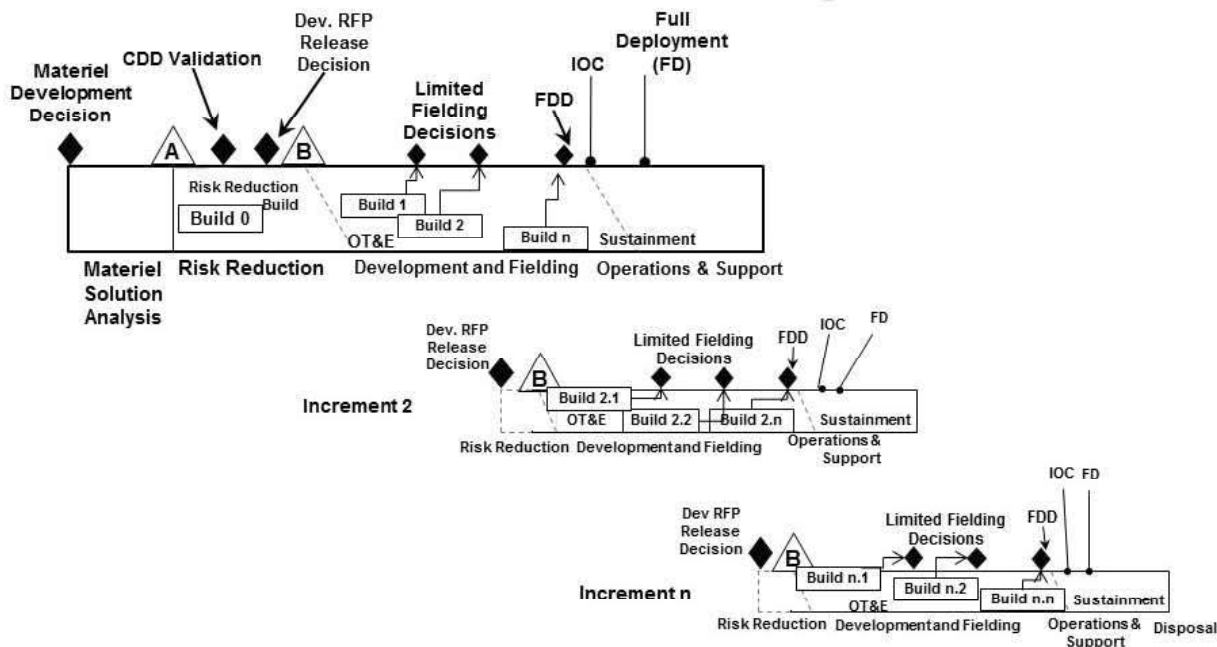

**Products requiring the application or modification of existing software adopted for DOD use in an incrementally fielded capability (includes most business systems and some weapons and command and control upgrade programs)**

**Figure 10-21. Model 3: Incrementally Deployed Software Intensive Program**

d. This phase ends when a DOD Component has completed the necessary analysis and the activities necessary to support a decision to proceed to the next decision point and desired phase in the acquisition process. The next phase can be Technology Maturation and Risk Reduction (TMRR), EMD, or P&D, depending on the actions needed to mature the product being acquired. Each of these phases has associated decision points to authorize entry: Milestone A, Development RFP Release and Milestone B, or Milestone C.

e. Program Office Establishment and Next Phase Preparation. During the Materiel Solution Analysis Phase, the CAE will select a Program Manager and establish a Program Office to complete the necessary actions associated with planning the acquisition program with emphasis on the next phase. Prior to preparation and release of a final RFP for the planned next phase, the Program Manager should complete and submit the Acquisition Strategy and obtain MDA approval. An approved Acquisition Strategy will inform development of the final RFPs for the next phase of the program.

### 10-38. Milestone A Review

a. The Program Manager will present the approach for acquiring the preferred materiel solution including: the Acquisition Strategy, the business approach, framing assumptions, an assessment of program risk and how specific technology development and other risk mitigation activities will reduce the risk to acceptable levels, and appropriate "Should Cost" management targets.

## Model 4: Accelerated Acquisition Program

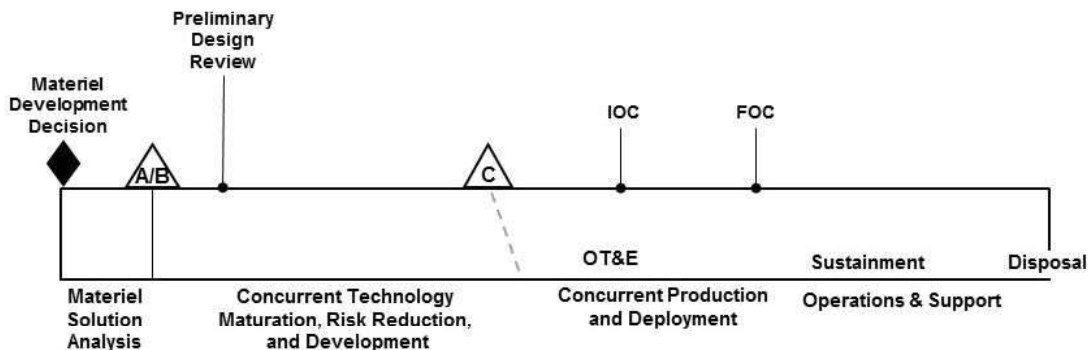

- Products that must be developed and acquired as quickly as possible, usually motivated by a potential adversary achieving technological surprise, and featuring a greater acceptance of program risk
- Schedule dominates over cost and technical risk considerations; compresses or eliminates phases and accepts the potential for inefficiencies to achieve a fielded capability on a compressed schedule
- One example of tailoring for accelerated acquisition; many others are possible

Figure 10-22. Model 4: Accelerated Acquisition Program

b. The DOD Component will present an affordability analysis and proposed affordability goals based on the resources that are projected to be available to the DOD Component in the portfolio(s) or mission area(s) associated with the program under consideration. The analysis will be supported by a quantitative assessment of all of the programs in the prospective program's portfolio or mission area that demonstrates the ability of the Component's estimated budgets to fund the new program over its planned life cycle. Affordability analyses are not intended to produce rigid, long-range plans; their purpose is to inform current decisions about the reasonableness of embarking on long-term capital investments at specific capability levels. The affordability analysis will support the Component's proposed affordability goals for unit production and sustainment costs for MDA approval and inclusion in the Milestone A ADM.

c. Demonstrate that the program will be fully funded within the FYDP at Milestone A.

d. If Milestone A is approved, the MDA will make a determination on the materiel solution, the plan for the TMRR Phase, release of the final RFP, and specific exit criteria required to complete TMRR and enter EMD. The MDA will document these decisions in an ADM.

e. If substantive changes to the plan approved at Milestone A are required as a result of the source selection process, the DOD Component will notify the MDA who may, at his or her discretion, conduct an additional review prior to contract awards.

### 10-39. Technology Maturation & Risk Reduction Phase

a. The purpose of this phase is to reduce technology, engineering, integration, and life-cycle cost risk to the point that a decision to contract for EMD can be made with confidence in successful program execution for development, production, and sustainment.

b. This phase should include a mix of activities intended to reduce the specific risks associated with the product to be developed. This includes additional design trades and requirements trades necessary to

## CAPABILITY REQUIREMENTS AND MATERIEL SYSTEM RESEARCH, DEVELOPMENT, AND ACQUISITION MANAGEMENT

ensure an affordable product and executable development and production programs. Capability requirements are matured and validated, and affordability caps are finalized during this phase. The TMRR Phase requires continuous and close collaboration between the program office and the requirements communities and authorities. During this phase, any realized Should Cost management savings should normally be used to further reduce program risk and future program costs.

c. This phase normally includes competitive sources conducting technology maturation and risk reduction activities and preliminary design activities up to and including a Preliminary Design Review (PDR) prior to source selection for the EMD Phase.

### Model 5: Hybrid Program A (Hardware Dominant)

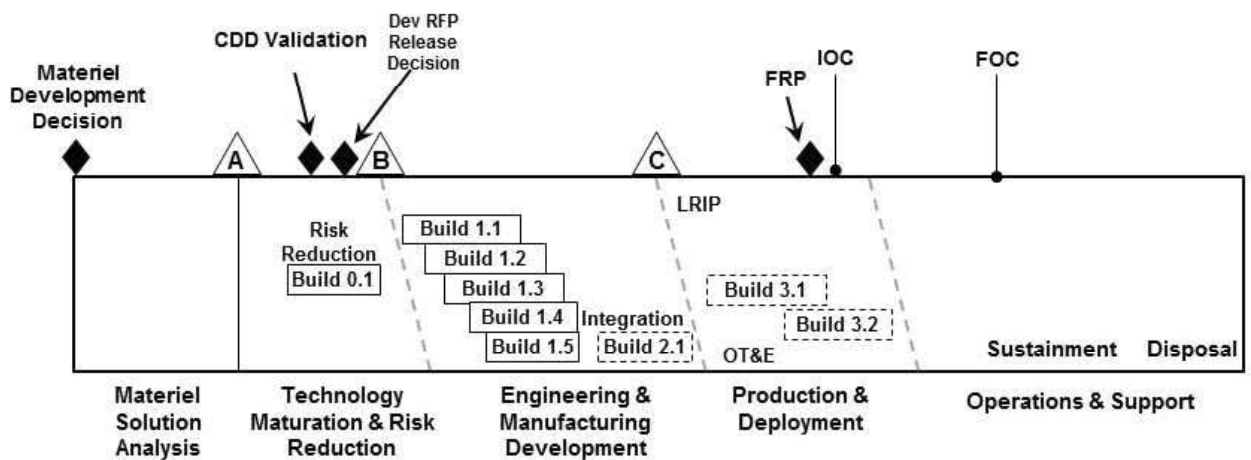

- Combines hardware development with software intensive development that is occurring simultaneously; software development will often dictate the pace of program execution and must be tightly integrated and coordinated with hardware development decision points
- Software development should be organized into a series of testable software builds; these builds should lead up to the full capability needed to satisfy program requirements and IOC; Milestones B and C decisions should include software functional capability development maturity criteria

Figure 10-23. Model 5: Hybrid Program A (Hardware Dominant)

## Model 6: Hybrid Program B (Software Dominant)

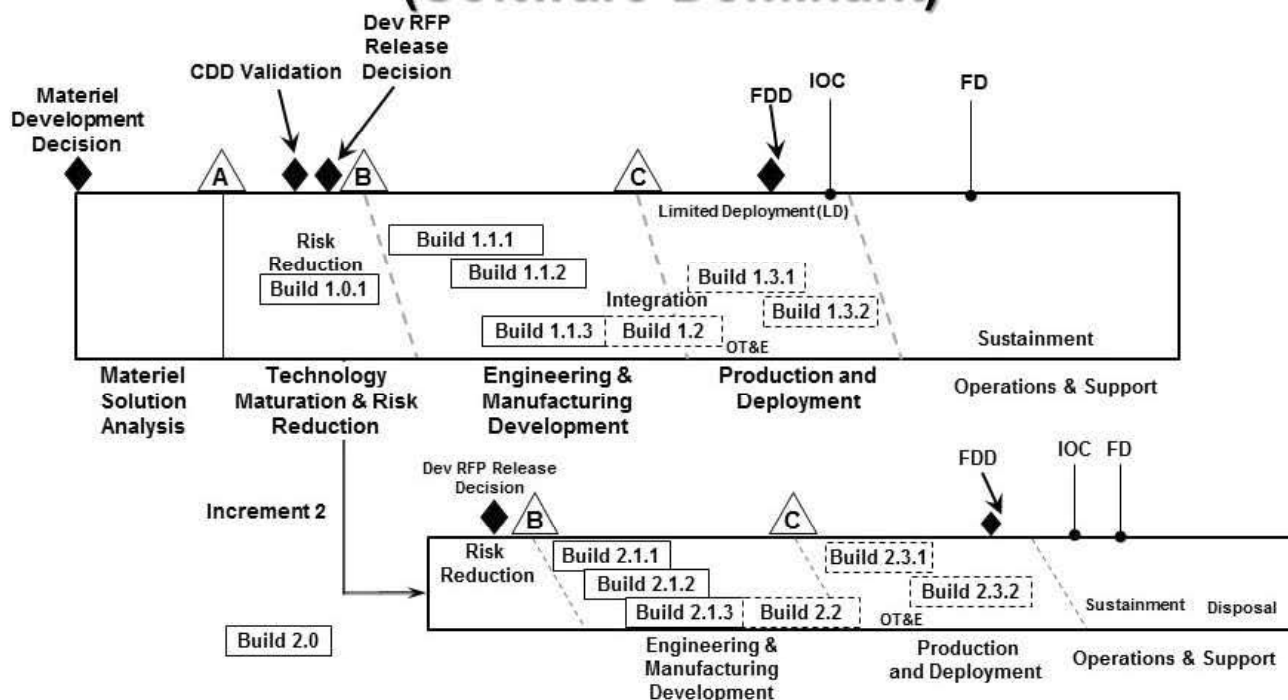

Mix of incrementally fielded software products/releases that include intermediate software builds

Figure 10-24. Model 6: Hybrid Program B (Software Dominant)

d. Risk reduction prototypes will be included if they will materially reduce engineering and manufacturing development risk at an acceptable cost. Risk reduction prototypes can be at the system level or can focus on sub-systems or components.

e. A competitive prototype, or if this is not feasible, a single prototype or prototyping of critical subsystems prior to Milestone B is statutorily required to be part of the Acquisition Strategy for MDAPs and is a regulatory requirement for all other programs.

f. The cost of producing competitive prototypes exceeds the expected life-cycle benefits (in constant dollars) of producing the prototypes, including the benefits of through competitive prototyping.

g. There are a number of ways to structure this phase which should be tailored to reduce the specific risks associated with the product being acquired. Technology Readiness Levels, described in the Technology Readiness Assessment (TRA) Guidance (Reference (e)), should be used to benchmark technology risk during this phase; however, these indices are rough benchmarks, and not conclusive about the degree of risk mitigation needed prior to development. Deeper analysis of the actual risks associated with the preferred design and any recommended risk mitigation must be conducted and provided to the MDA.

h. The Acquisition Strategy will guide this phase. Multiple technology development demonstrations, defined in the acquisition strategy, may be necessary before the operational user and material developer can substantiate that a preferred solution is feasible, affordable, and supportable; satisfies validated capability requirements; and has acceptable technical risk. Planning for EMD, production, developmental

## CAPABILITY REQUIREMENTS AND MATERIEL SYSTEM RESEARCH, DEVELOPMENT, AND ACQUISITION MANAGEMENT

and operational test, and life-cycle sustainment of proposed products will occur during this phase. The government will update the program IP Strategy to ensure the ability to compete future sustainment efforts consistent with the Acquisition Strategy to include competition for spares and depot repair.

i. During this phase, and timed to support CDD validation (or its equivalent), the Program Manager will conduct a systems engineering trade-off analysis showing how cost and capability vary as a function of the major design parameters. The analysis will support the assessment of refined KPPs/KSAs in the CDD. Capability requirements proposed in the CDD (or equivalent requirements document) should be consistent with program affordability goals.

j. Subsequent to CDD validation, the Program Manager will conduct additional requirements analysis including: requirements decomposition and allocation, definition of internal and external interfaces, and design activities leading to a PDR. Unless waived by the MDA, the PDR will occur prior to Milestone B.

k. During the TMRR Phase, the Program Manager will plan the balance of the program, prepare for subsequent decision points and phases, and submit an updated Acquisition Strategy for MDA approval. The updated Acquisition Strategy will describe the overall approach to acquiring the capability to include the program schedule, risks, funding, and the business strategy. The business strategy will describe the rationale for the contracting approach and how competition will be maintained throughout the program life cycle, and detail how contract incentives will be employed to support the Department's goals.

### 10-40. Milestone B

a. This milestone provides authorization to enter into the EMD Phase and for the DOD Components to award contracts for EMD. It also commits the required investment resources to the program. Most requirements for this milestone should be satisfied at the Development RFP Release Decision Point; however, if any significant changes have occurred, or if additional information not available at the Development RFP Release Decision Point could impact this decision, it must be provided at the Milestone B. Milestone B requires final demonstration that all sources of risk have been adequately mitigated to support a commitment to design for production. This includes technology, engineering, integration, manufacturing, sustainment, and cost risks. Validated capability requirements, full funding in the FYDP, and compliance with affordability goals for production and sustainment, as demonstrated through an independent cost estimate (ICE), are required. The framing assumptions central to shaping the program's cost, schedule, and performance expectations are also required.

b. Milestone B is normally the formal initiation of an acquisition program with the MDA's approval of the Acquisition Program Baseline (APB). The APB is the agreement between the MDA and the Program Manager and his or her acquisition chain of command that will be used for tracking and reporting for the life of the program or program increment. The APB will include the affordability caps for unit production and sustainment costs. Affordability caps are established as fixed cost requirements equivalent to KPPs.

c. At the milestone, the MDA will finalize the following, if not already completed:

- (1) The Low Rate Initial Production (LRIP) quantity or the scope of limited deployment, as applicable.
- (2) The specific technical event-based criteria for initiating production or making deployment decisions.
- (3) Document decisions in an ADM.

### 10-41. Engineering & Manufacturing Development Phase

a. The purpose of the EMD Phase is to develop, build, and test a product to verify that all operational and derived requirements have been met, and to support production or deployment decisions.

b. General. EMD completes all needed hardware and software detailed design; systemically retires any open risks; builds and tests prototypes or first articles to verify compliance with capability requirements; and prepares for production or deployment. It includes the establishment of the initial product baseline for all configuration items.

c. Design. The system design effort usually includes a standard series of design reviews prior to test article fabrication and/or software build or increment coding. Multiple design iterations may be necessary to converge on a final design for production. The SEP provides the basis for design activities.

d. Post-Milestone B PDR. If a PDR prior to Milestone B has been waived, the Program Manager will plan for a PDR as soon as feasible after program initiation.

### 10-42. Engineering & Manufacturing Development Phase Entrance Criteria

a. Developmental Test and Evaluation (DT&E). Developmental testing and evaluation provides feedback to the Program Manager on the progress of the design process and on the product's

compliance with contractual requirements. DT&E activities also evaluate the ability of the system to provide effective combat capability, including its ability to meet its validated and derived capability requirements, including the verification of the ability of the system to achieve KPPs and KSAs, and that initial system production and deployment and Operational Test and Evaluation (OT&E) can be supported. The effort requires completion of DT&E activities consistent with the TEMP. Successful completion of adequate testing with production or deployment representative prototype test articles will normally be the primary basis for entering LRIP or Limited Deployment.

b. Early OT&E Events. Independent operational assessments, conducted by the Component operational test organization, will normally also occur during EMD. These events may take the form of independent evaluation of developmental test results or of separate dedicated test events such as Limited User Tests. Developmental and operational test activities should, to the extent feasible, be planned in conjunction with one another to provide as efficient an overall test program as possible.

c. Preparation for Production, Deployment, and Sustainment. During EMD, the Program Manager will finalize designs for product support elements and integrate them into a comprehensive product support package. Early in the EMD Phase, the Program Manager's initial product support performance requirements allocations will be refined based on the results of engineering reviews. Later in this phase, programs will demonstrate product support performance through test, to ensure the system design and product support package meet the sustainment requirements within the affordability capabilities established at Milestone B.

### 10-43. Post-Critical Design Review Assessment

a. The MDA conducts a formal program assessment following system-level CDR. The system-level CDR provides an opportunity to assess design maturity as evidenced by measures such as: successful completion of subsystem CDRs; the percentage of hardware and software product build-to specifications and drawings completed and under configuration management; planned corrective actions to hardware/software deficiencies; adequate DT; the identification of key system characteristics; the maturity of critical manufacturing processes; and an estimate of system reliability based on demonstrated reliability rates.

b. The PM provides a post-CDR report to the MDA that provides an overall assessment of design maturity and a summary of the system-level CDR results. The MDA reviews the post-CDR report and the PM's resolution/mitigation plans and determines whether additional action is necessary to satisfy EMD phase exit criteria. The results of the MDA's post-CDR assessment are documented in the ADM. Successful completion of the post-CDR assessment ends the integrated system design work effort and continues the EMD phase into system capability and manufacturing process demonstration work effort. This work effort is intended to demonstrate the ability of the system to operate in a useful way consistent with the approved KPPs, and that system production can be supported by demonstrated manufacturing processes. The program enters system capability and manufacturing process demonstration upon completion of the post-CDR assessment and establishment of an initial product baseline. This work effort ends when the system meets validated requirements and is demonstrated in its intended operational environment, using the selected production-representative article; manufacturing processes have been effectively demonstrated; industrial capabilities are reasonably available; and the system meets or exceeds exit criteria and MS C entrance requirements.

c. Successful DT to assess technical progress against critical technical parameters, early operational assessments, and, where proven capabilities exist, the use of M&S to demonstrate system/SoS integration are critical during this effort. T&E assesses improvements to mission capability and operational support based on user needs and is reported in terms of operational significance to the user. The completion of the EMD phase is dependent on a decision by the MDA to commit to the program at MS C or a decision to end this effort.

### 10-44. Engineering and Manufacturing Development Phase Completion

a. The EMD Phase will end when:

- (1) The design is stable.
- (2) The system meets validated capability requirements demonstrated by developmental and initial operational testing as required in the TEMP.
- (3) Manufacturing processes have been effectively demonstrated and are under control.
- (4) Software sustainment processes are in place and functioning.

# CAPABILITY REQUIREMENTS AND MATERIEL SYSTEM RESEARCH, DEVELOPMENT, AND ACQUISITION MANAGEMENT

(5) Industrial production capabilities are reasonably available.

(6) The system has met or exceeds all directed EMD Phase exit criteria and Milestone C entrance criteria. EMD will often continue past the initial production or fielding decision until all EMD activities have been completed and all requirements have been tested and verified.

b. **Concurrency Between EMD and Production.** In most programs for hardware intensive products, there will be some degree of concurrency between initial production and the completion of developmental testing; and perhaps some design and development work, particularly completion of software, that will be scheduled to occur after the initial production decision. Concurrency between development and production can reduce the lead time to field a system, but it also can increase the risk of design changes and costly retrofits after production has started. Program planners and decision authorities should determine the acceptable or desirable degree of concurrency based on a range of factors. In general, however, there should be a reasonable expectation, based on developmental testing of full-scale EMD prototypes, that the design is stable and will not be subject to significant changes following the decision to enter production. At Milestone B, the specific technical event-based criteria for initiating production or fielding at Milestone C will be determined and included in the Milestone B ADM.

## 10-45. Milestone C

a. Milestone C and the Limited Deployment Decision are the points at which a program or increment of capability is reviewed for entrance into the P&D Phase or for Limited Deployment. Approval depends in part on specific criteria defined at Milestone B and included in the Milestone B ADM. The following general criteria will normally be applied: demonstration that the production/deployment design is stable and will meet stated and derived requirements based on acceptable performance in developmental test events; an operational assessment; mature software capability consistent with the software development schedule; no significant manufacturing risks; a validated Capability Production Document (CPD) or equivalent requirements document; demonstrated interoperability; demonstrated operational supportability; costs within affordability caps; full funding in the FYDP; properly phased production ramp up; and deployment support.

b. In making Milestone C and Limited Deployment decisions, the MDA will consider any new validated threat environments that were not included in the CPD and might affect operational effectiveness, and will consult with the requirements validation authority as part of the production decision making process to ensure that capability requirements are current.

c. MDA decisions at Milestone C and Limited Deployment Decisions will be documented in an ADM following the review.

d. **High-Cost First Article Combined Milestone B and C Decisions.** Some programs, notably spacecraft and ships, will not produce prototypes during EMD for use solely as test articles because of the very high cost of each article. In this case, the first articles produced will be tested and then fielded as operational assets. These programs may be tailored by measures such as combining the development and initial production investment commitments. When this is the case, a combined Milestone B and C will be conducted. Additional decision points with appropriate criteria may also be established for subsequent low rate production commitments that occur prior to OT&E and a Full-Rate Production Decision.

## 10-46. Production & Deployment Phase

a. The purpose of the P&D Phase is to produce and deliver requirements-compliant products to receiving military organizations.

b. **Phase Description.** In this phase, the product is produced and fielded for use by operational units. The phase encompasses several activities and events: LRIP, Limited Deployment, OT&E, and the Full-Rate Production Decision or the Full Deployment Decision followed by full-rate production or full deployment. In this phase, all system sustainment and support activities are initiated if they haven't already commenced. During this phase the appropriate operational authority will declare IOC when the defined operational organization has been equipped and trained and is determined to be capable of conducting mission operations. During this phase Should Cost management and other techniques will be used continuously to control and reduce cost.

c. **LRIP and Limited Deployment.** LRIP establishes the initial production base for the system or capability increment, provides the OT&E test articles, provides an efficient ramp up to full-rate production, and maintains continuity in production pending OT&E completion. While this portion of the phase should be of limited duration so that efficient production rates can be accomplished as soon and as economically

as possible, it should be of sufficient duration to permit identification and resolution of any deficiencies prior to full-rate production. Limited Deployment for software developments is principally intended to support OT&E and can, consistent with the program strategy, be used to provide tested early operational capability to the user prior to full deployment.

d. OT&E. The appropriate operational test organization will conduct operational testing in a realistic threat environment. The threat environment will be based on the program's System Threat Assessment Report and appropriate scenarios. For MDAPs, MAIS programs, and other programs on the DOT&E Oversight List, the DOT&E will provide a report providing the opinion of the DOT&E as to whether the program is operationally effective, suitable, and survivable before the MDA makes a decision to proceed beyond LRIP. For programs on the DOT&E Oversight List, operational testing will be conducted in accordance with the approved TEMP and operational test plan. If LRIP is not conducted for programs on the DOT&E Oversight List, fully production-representative articles must nonetheless be provided for the conduct of the required operational testing.

### **10-47. Low-Rate Initial Production Work Effort**

a. This work effort is intended to result in completion of manufacturing development in order to ensure adequate and efficient manufacturing capability and to produce at least the minimum quantity necessary to provide production configured or representative articles for IOT&E; establish an initial production base for the system; and permit an orderly increase in the production rate for the system, sufficient to lead to full-rate production upon successful completion of operational (and live-fire, where applicable) testing.

b. Deficiencies encountered in testing prior to MS C are resolved prior to proceeding beyond LRIP (at the FRP decision review) and any fixes verified in IOT&E. Test Resource Plans (TRP) are provided to the D,OT&E for oversight programs in advance of the start of OT.

c. LRIP may be funded by RDT&E appropriation or by procurement appropriation, depending on the intended usage of the LRIP systems.

d. LRIP quantities are minimized. The D,OT&E determines the LRIP quantity for MDAPs and major systems at MS B, and provides rationale for quantities exceeding 10 percent of the total production quantity documented in the AS. Any increase in quantity after the initial determination, must be approved by the D,OT&E. When approved LRIP quantities are expected to be exceeded because the program has not yet demonstrated readiness to proceed to full-rate production, the MDA, in coordination with the DOT&E, assesses the cost and benefits of a break in production versus continuing annual buys.

### **10-48. Full-Rate Production Decision Review**

a. An acquisition program may not proceed beyond LRIP without approval of the MDA at the FRP decision review. Before making the full-rate production and deployment decision, the MDA considers:

- (1) The CCE, and for MAISs, the CCE and economic analysis
- (2) The manpower estimate (if applicable)
- (3) The results of operational and live fire test (if applicable)
- (4) CCE compliance certification and certification for MAISs
- (5) C4I supportability certification
- (6) Interoperability certification

b. The MDA approves the AS prior to the release of the final RFP, the production APB, and the ADM. The decision to continue beyond low-rate to full-rate production, or beyond limited deployment of AISs or software-intensive systems with no developmental hardware requires completion of IOT&E, submission of the Beyond LRIP Report for DOT&E oversight programs, and submission of the Live-Fire Test and Evaluation (LFT&E) Report (where applicable) to the USD (AT&L), to the SECDEF, and to Congress.

### **10-49. Full-Rate Production and Deployment Work Effort**

This work effort delivers the fully funded quantity of systems and supporting materiel and services to the users. During this work effort, units attain initial operational capability (IOC). The IOC is the first attainment of the capability by a MTOE unit and supporting elements to operate and maintain effectively a production item or system provided the following:

- a. The item or system has been type classified as standard or approved for limited production.
- b. The unit and support personnel have been trained to operate and maintain the item or system in an operational environment.
- c. The unit can be supported in an operational environment in such areas as special tools, test



# CAPABILITY REQUIREMENTS AND MATERIEL SYSTEM RESEARCH, DEVELOPMENT, AND ACQUISITION MANAGEMENT

equipment, repair parts, documentation, and training devices.

## 10-50. Operations & Support Phase

The objective of this activity/phase is the execution of a support program that meets materiel readiness and operational support performance requirements and sustains the system in the most cost-effective manner over its total life-cycle. When the system has reached the end of its useful life, it must be disposed of in an appropriate manner. Planning for this phase begins prior to program initiation and is documented in the Life-Cycle Sustainment Plan (LCSP). The O&S phase has two major work efforts – life-cycle sustainment and disposal.

## 10-51. Life-Cycle Sustainment Work Effort

a. The life-cycle sustainment program includes all elements necessary to maintain the readiness and operational capability of deployed systems. The scope of support varies among programs, but generally includes supply, maintenance, transportation, sustaining engineering, data management, configuration management, manpower, personnel, training, habitability, survivability, safety (including explosives safety), occupational health, protection of Critical Program Information (CPI), anti-tamper provisions, IT (including National Security System (NSS)) supportability and interoperability, and environmental management functions. This activity includes the execution of operational support plans in peacetime, crises, and wartime. Programs with software components must be capable of responding to emerging requirements that will require software modification or periodic enhancements after a system is deployed. An FOT&E program that evaluates operational effectiveness, survivability, suitability, supportability, interoperability, and that identifies and ensures deficiencies are later corrected, is conducted, as appropriate.

b. Supporting the tenets of evolutionary acquisition, sustainment strategies must evolve and be refined throughout the life-cycle, particularly during development of subsequent blocks of an evolutionary strategy, modifications, upgrades, and re-procurement. The PM ensures that a flexible, performance-oriented strategy to sustain systems is developed and executed. This strategy includes consideration of the full scope of operational support, such as maintenance, supply, transportation, sustaining engineering, spectrum supportability, configuration and data management, manpower, training, environmental, health, safety, disposal, and security factors. The use of performance requirements or conversion to performance requirements are emphasized during re-procurement of systems, subsystems, components, spares, and services after the initial production contract.

c. The PM works with the CAPDEV to document performance and sustainment requirements in performance agreements specifying objective outcomes, measures, resource commitments, and stakeholder responsibilities. The PM employs effective performance-based life-cycle product support planning, development, implementation, and management. Performance-Based Logistics (PBL) product support represents the latest evolution of performance based logistics. Both can be referred to as PBL. PBL offers the best strategic approach for delivering required life-cycle readiness, reliability, and ownership costs. Sources of support may be organic, commercial, or a combination, with the primary focus optimizing customer support, weapon system availability, and reduced ownership costs.

## 10-52. Disposal Work Effort

At the end of its useful life, a system must be demilitarized and disposed of in accordance with all legal and regulatory requirements and policy relating to safety (including explosives safety), security, and the environment. During the design process, PMs document hazardous materials contained in the system, and estimate and plan for demilitarization and safe disposal. The demilitarization of conventional munitions (including any item containing propellants, explosives, or pyrotechnics) shall be considered during systems design.

## 10-53. Additional Considerations

The above discussion examined the activities performed in each phase of the nominal life-cycle of an acquisition system according to the current DODD 5000.01, DODI 5000.02, and AR 70-1. This is not to imply that all system developments must follow this exact sequencing of life-cycle phases and activities. On the contrary, DODI 5000.02 specifically authorizes and encourages a PEO/PM to devise program structures and acquisition strategies to fit that specific program – an approach called “tailoring.” Other aspects of acquisition planning and strategy can also be accommodated under the broad guidance and

direction contained in DODD 5000.01 and DODI 5000.02. What remains constant is the task to develop and deliver combat-capable, cost-effective, and supportable systems to our Soldiers.

### Section XI Acquisition Oversight and Review

#### 10-54. Defense Acquisition Board

The Defense Acquisition System (DAS) is controlled by decisions made as the result of various acquisition programs MDRs conducted by appropriate management levels at program MSs. The reviews are the mechanism for checking program progress against approved plans and for developing revised APBs. Approval of APBs and plans in these reviews do not constitute program funding approval; and allocation of funds in the PPBE process is required.

a. The function of the DAB is to review DOD ACAT ID programs to ensure that they are ready for transition from one DAS program phase to the next. The DAB is the DOD senior-level acquisition forum for advising the USD(AT&L), as the DAE, on critical decisions concerning ACAT ID programs. DAB reviews focus on key principles to include interoperability, time-phased requirements related to an evolutionary strategy, and demonstrated technical maturity. The DAB is composed of DOD senior-level officials. The board is chaired by the USD(AT&L). Other principal members include: the VCJCS; Under Secretary of Defense (Comptroller); Under Secretary of Defense (Policy); Under Secretary of Defense (Personnel & Readiness); Under Secretary of Defense for Intelligence; DOD Chief Information Officer; Director, Cost Assessment and Program Evaluation; Director, Operational Test and Evaluation; and the Secretaries of the Army, Navy, and the Air Force. The Director, Acquisition Resources and Analysis serves as the DAB Secretary; and additional advisors as required.

b. Approximately one week prior to the DAB review, the OIPT meets to pre-brief the OIPT leader. The purpose of the meeting is to update the OIPT leader on the latest status of the program and to inform the senior acquisition officials of any outstanding issues and to insure the program is ready for a formal DAB review.

c. The JROC reviews all deficiencies that may necessitate development of ACAT I systems prior to any consideration by the DAB at MS B. The JROC validates an identified materiel need and forwards the capabilities requirements documents with JROC recommendations to the USD(AT&L). In addition, the JROC continues a role in validation of KPPs in program baselines prior to scheduled reviews for ACAT I programs prior to all successive MDRs.

d. A formal DAB review is the last step of the DAB review process. The PM briefs the acquisition program to the DAB and specifically emphasizes technology maturity, risk management, affordability, critical program information, technology protection, and rapid delivery to the user. The PM addresses any interoperability and supportability requirements linked to other systems and indicates whether those requirements will be satisfied by the AS under review. If the program is part of a system-of-systems architecture, the PM briefs the DAB in that context.

e. Following presentations by the PM and a full discussion, the USD(AT&L), as DAE, decides to continue, alter, or terminate the program. This decision is published in an ADM.

#### 10-55. Army Systems Acquisition Review Council

a. The ASARC is the Army's senior-level acquisition advisory body for ACAT IC and selected ACAT II programs, ACAT ID programs (DAB managed) prior to a DAB. The ASARC convenes at formal MSs to determine a program or system's readiness to enter the next phase of the materiel acquisition cycle, and makes recommendations to the AAE on those programs for which the AAE is the MDA. An ASARC may be convened at any time to review the status of a program. The ASARC is chaired by the AAE.

b. ASARC membership includes the Assistant Secretary of the Army (Acquisition, Logistics and Technology) – AAE; Vice Chief of Staff, Army (VCSA); Deputy Under Secretary of the Army – Test and Evaluation Executive; Assistant Secretary of the Army (Financial Management and Comptroller); Assistant Secretary of the Army (Installations, Energy, and Environment); Assistant Secretary of the Army (Manpower and Reserve Affairs); CG, Army Materiel Command; Training and Doctrine Command (ARCIC); Office of the General Counsel; DCS, G-1; DCS, G-2; DCS, G-3/5/7; DCS, G-4; CIO/G-6; DCS, G-8 (FD); DCS G-8 (PA&E); Office of Small Business; Office of the Chief, Army Reserve; Army National Guard/National Guard Bureau; Army Test and Evaluation Command (ATEC); and

# CAPABILITY REQUIREMENTS AND MATERIEL SYSTEM RESEARCH, DEVELOPMENT, AND ACQUISITION MANAGEMENT

PEO/DPEO/PM. Other organizations are invited to attend, if a significant issue is identified within their area of responsibility. The AAE makes the final decision as to the attendance at the ASARC.

## 10-56. In-Process Review

a. The IPR is a formal acquisition review forum for ACAT III programs. General policies for reviews for IPR programs are the same as for ACAT I and II programs. Reviews are conducted at MSs and at other times deemed necessary by the MDA. The MDA, usually the assigned PEO, chairs the IPR.

b. The IPR brings together representatives of the MATDEV, the CAPDEV, the trainer, the logistician, and the independent evaluators for a joint review and decision on proceeding to the next phase of development. Their purpose is to provide recommendations, with supporting rationale, as a basis for system concept, system development, type classification, and production decisions by the appropriate level of authority. They are the forums where agencies responsible for participating in the materiel acquisition process can present their views and ensure that those views are considered during development, test, evaluation, and production. Participation is extended to the appropriate testing agencies, HQDA representatives, and to others as designated by the IPR chairman.

## 10-57. Configuration Steering Board

a. Section 814 of the 2009 National Defense Authorization Act (NDAA) requires the Secretary of each military department to establish a CSB for DAS post MS B ACAT I programs. Meeting annually, the CSB is responsible for reviewing all requirements changes and any significant technical configuration changes for ACAT I programs in development that have the potential to result in cost and schedule impacts to the program. Changes are not approved unless funds are identified and schedule impacts are mitigated. CSBs were designed to monitor programs and avoid requirements creep. The law does not limit the CSB process to ACAT I programs; it may be used for other ACAT programs.

b. The 2009 NDAA explicitly provides PMs with the authority to challenge new program requirements. The PM, in consultation with the PEO, identifies and proposes a set of de-scoping options, with supporting rationale addressing operational implications that reduce program cost or moderate requirements. The CSB recommends to the MDA which of these options should be implemented. Final decisions on de-scoping option implementation are coordinated with the appropriate Joint Staff and military department requirements officials. These checks and balances provide a framework for the acquisition executive to challenge requirements without sacrificing the Services' accountabilities to ensure user requirements are met.

c. In the Army, the CSB consists of the following principal members: Army Acquisition Executive (Chair); Vice Chief of Staff, Army (Vice-Chair); Principal Military Deputy, Office of the Assistant Secretary of Army (Acquisition, Logistics, and Technology); PEO; Senior executive representatives from the office of the Under Secretary of Defense (Acquisition, Technology, and Logistics); Joint Staff; CG, ATEC; Chief, Army Reserve; Chief, National Guard Bureau; Director, Army T&E office; CG, TRADOC/ARCIC.

## 10-58. Life-Cycle Management Commands

a. In an effort to improve system life-cycle management, a Memorandum of Agreement (MOA) was signed by the ASA(ALT) and the CG, AMC, to establish the LCMCs and bring the acquisition, logistics, and technology communities together to support the PM as the single total life-cycle manager or "the trail boss" for assigned warfighting systems. The LCMC MOA was signed on August 2, 2004 and the LCMC initiative was approved by the CSA on August 16, 2004. The LCMC MOA aligned AMC system "commodity" commands with their related PEOs into four product-focused LCMCs. The four LCMCs are:

- (1) Aviation and Missile (AMCOM) LCMC, Huntsville, Alabama.
- (2) TACOM (formerly known as Tank-automotive and Armaments Command) LCMC, Warren, Michigan.
- (3) Communications-Electronics Command (CECOM) LCMC, Aberdeen Proving Ground, Maryland.
- (4) Joint Munitions and Lethality (JM&L) LCMC, Picatinny Arsenal, New Jersey.

b. Numerous other PEOs were not affected under the initial construct regarding the LCMC initiative.

## 10-59. Integrated Process Team

DODD 5000.01 directs the DOD acquisition community to utilize IPTs to facilitate the management and exchange of program information. IPTs integrate all acquisition activities starting with capabilities development through production, fielding/deployment, and operational support in order to optimize the design, manufacturing, business, and supportability processes. The IPT is composed of representatives

## HOW THE ARMY RUNS

from all appropriate functional disciplines working together with a team leader to build successful and balanced programs, identify and resolve issues, and make sound and timely recommendations to facilitate decision-making. There are two levels of IPTs: OIPTs focus on strategic guidance, program executability (cost, schedule, risk), and issue resolution; and the Working-level Integrated Product Teams (WIPT), that identify and resolve program issues, determine program status, and seek opportunities for acquisition reform.

a. Overarching Integrated Product Team. In support of all ACAT ID programs, an OIPT is formed to provide assistance, oversight, and review as that program proceeds through its acquisition life-cycle. The OIPT for ACAT ID programs is led by the appropriate OSD Principal Staff Assistant (PSA) or Technical Director. Program OIPTs are composed of the PM, PEO, component staff, Joint Staff, USD(AT&L) staff, and the OSD staff principals or their representatives, involved in oversight and review of a particular ACAT ID program.

(1) In the Army, an ASARC OIPT is established at the direction of the MDA for ACAT IC and most ACAT II programs. The ASARC OIPT is a team of HQDA staff action officers and the PEO/PM/TCM responsible for integration of oversight issues to be raised to the MDR forums.

(2) The secretary/facilitator of the ASARC OIPT for Army ACAT I and II programs is the DASC, in ASA(ALT), for that specific program. OIPT membership consists of empowered individuals appointed by ASARC members (ACAT IC or selected ACAT II programs), and the MDA for ACAT III programs. Team membership is tailored based on the needs and level of oversight for the individual program. Typical ASARC OIPT responsibilities include:

(a) Meeting with the PEO/PM throughout program development to raise and resolve issues early, providing recommendations for tailoring and streamlining the program

(b) Linking vertically with the PM's WIPTs

(c) Helping the PM successfully achieve a MS decision

(d) Providing an independent assessment for the MDA in preparation for the MDR

(e) Developing a memorandum documenting the issues/risks to be raised to the MDA with a recommendation to the MDA

(3) The OIPT, at all levels, follow the general procedures that are described below for a typical ACAT ID program. Initially the OIPT meets to determine the extent of WIPT support needed for the potential program, who shall be members of the WIPTs, the appropriate MS for program initiation, and the minimum information needed for the program initiation review. The OIPT leader is responsible for taking action to resolve issues when requested by any member of the OIPT or when directed by MDA. The goal is to resolve as many issues and concerns at the lowest level possible, and to expeditiously escalate issues that need resolution at a higher level, bringing only the highest-level issues to the MDA for decision. The OIPT meets as necessary over the life of a program.

(4) WIPTs. WIPTs are established for all acquisition programs. The number and membership of the WIPTs are tailored to each acquisition phase based on the level of oversight and the program needs. They are comprised of HQDA and/or Service/functional action officers and normally chaired by the PM or designee. WIPTs provide advice to the PM and help prepare program strategies and plans. Each WIPT focuses on a particular topic(s), such as T&E, cost/performance, risk management (both programmatic and safety), etc.

### Section XII Acquisition Documentation

#### 10-60. Army Catalog of Approved Requirements Documents

Army CARDS is an unclassified HQDA DCS, G-8/FD publication that provides information on the status of all validated capability requirements documents. It includes both active and inactive requirement documents. An active document or assignment of a CARDS reference number does not automatically authorize the expenditure of funds. Each program must compete for funds in the Army prioritization and programming process. The HQDA DCS, G-8/FD assigns a CARDS reference number to each capability requirements document after approval and prior to publication and distribution. ARCIC loads the CARDS in SLAMIS after they receive the TRADOC copy of the JCIDS Document approval memo. There are multiple processes that use SLAMIS data for their various purposes. The CARDS is often used to represent / point to the approved requirement. BOIP Feeder Data is one of those processes - - currently

# CAPABILITY REQUIREMENTS AND MATERIEL SYSTEM RESEARCH, DEVELOPMENT, AND ACQUISITION MANAGEMENT

loaded into / processed within SLAMIS - - that requires a CARDS be attached to the PM's data set.

## 10-61. Program Review Documentation and Program Plans

The MDA is responsible for identifying the minimum amount of documentation necessary for MS review purposes. Only those mandatory formats called for by statute or DODI 5000.02 are required. All other formats are used as guidance only. Program plans are a description of the detailed activities necessary for executing the AS. Program plans belong to the PM and are used by the PM to manage program execution throughout the life-cycle of the program. The PM, in coordination with the PEO, determines the type and number of program plans, except those required by statute or DOD policy. Some of the typical program plans used to support the execution of a program are:

a. Validated On-Line Life-cycle Threat (VOLT) Report. The VOLT is the basic authoritative threat assessment that supports the development and acquisition of a particular ACAT I or II system. The VOLT contains an integrated assessment of projected enemy capabilities (doctrine, tactics, hardware, organization, and forces) at IOC and IOC plus 10 years, to limit, neutralize, or destroy the system. It explicitly identifies Critical Intelligence Categories (CIC), which are a series of threat capabilities that could critically impact the effectiveness and survivability of the program. The VOLT is a dynamic document that is continually updated and refined as a program develops. It is approved and validated in support of MDRs. This report is the primary threat reference for the CDD, the AoA, and the TEMP developed in support of a MDR. The VOLT is approved by HQDA DCS, G-2 and validated by the DIA for all ACAT I and DOT&E Oversight List programs at MS B and updated at MS C.

b. Acquisition Strategy (AS). The AS is the framework (roadmap) for planning, directing, and managing a materiel acquisition program. It states the concepts and objectives that direct and control overall program execution from program initiation through post-production support. An AS is required for all Army acquisition programs regardless of ACAT. The AS documents how the acquisition program will be tailored and identifies risks and plans to reduce or eliminate risks. The AS, prepared by the PM-led WIPT, is a living document that matures throughout the program. It provides fundamental guidance to the functional elements of the MATDEV/CAPDEV organizations.

c. Acquisition Plan (AP). A formal written document that articulates specific contractual activities necessary to execute the approved acquisition strategy for major system acquisitions.

d. Analysis of Alternatives (AoA).

(1) To support the Acquisition System, TRAC conducts Joint and Army AoAs. These are typically sponsored by DOD or HQDA. The Joint / Army AoAs are HQDA-tasked, Army / OSD Study Advisory Group (SAG)-directed, TRAC-led, and ASARC-approved. The AoA evaluates potential materiel solutions to satisfy validated capabilities and supports a decision on the most cost effective, affordable solution to meet the validated capability requirement(s). The AoA is required (statutory) at Milestone (MS) A, and updated as necessary prior to MS B at the RFP Release Decision Point and at MS C. Major defense acquisition programs must have an AoA, with the exception of rapid acquisitions supporting current operations and MS C and beyond. The DOD decision support systems provide an integrated approach to strategic planning, capability assessment, system acquisition, and program budget development. The purpose of AoA is not to "support a decision" (predisposed outcome or desired answer); rather, it is to "enable a decision" to be made and to "underpin the decision" with compelling, defensible evidence.

(2) The AoA assesses potential materiel solutions to satisfy the capability need documented in the approved Initial Capabilities Document (ICD) and often plays a supporting role in crafting a cost-effective and balanced evolutionary acquisition strategy. AoAs accomplish the following: evaluate cost, performance, and schedule (with associated risks) to deliver a militarily useful capability to mitigate capability gaps; identify the trades in cost, performance, and schedule; identify the technology cost drivers and integration risks; illuminate capability advantages and disadvantages; consider joint operational plans; examine sufficient feasible alternatives; discuss key assumptions and variables and sensitivity to changes in these; estimate costs; assess the fully burdened cost of fuel; and assess system training and logistics impacts to ensure that effective and efficient training and logistical support is provided with the system.

(3) The AoA study team is created based on types of issues and types of concepts or systems being studied. The study sponsor provides guidance. The lead agency provides the study director who leads the AoA. The SAG approves the study plan and study results. SAG is a group of general officer-level stakeholders, to include the study sponsor (sometimes called a TSAG at the TRADOC level or a JSAG at the Joint level). The study director owns the study and is ultimately responsible for all aspects of the

analysis. The study director ensures quality throughout the study process and that the sponsor receives the most relevant information available to inform their decisions. To be effective, each AoA requires input from and participation by the entire stakeholder community.

(4) Once the AoA report is finished and the final results brief approved by the SAG, the final products (brief and written report) are reviewed by senior OSD CAPE personnel to ensure the AoA sufficiently addressed the study issues to the necessary degree and the results of the analysis are sufficient to support pending acquisition decisions. If it is found to meet both objectives, a memo of sufficiency is produced and the AoA is considered complete. Without this approval, the AoA may require additional work for acceptability.

f. Acquisition Program Baseline (APB). APBs consist of the concept baseline, the development baseline, and the production baseline approved at MS B, C, and FRP, respectively. The purpose of the baselines is to enhance program stability and to provide a critical reference point for measuring and reporting the status of program implementation. Each baseline contains objectives for key cost, schedule, and performance parameters. Key parameters must meet minimum acceptable requirements, known as thresholds, at each MS decision point. The thresholds establish deviation limits from which a PM may not trade-off cost or performance without authorization from the MDA. The APB must cross-walk to the program CDD or CPD for performance parameters. Failure to meet the threshold requires a reevaluation of alternative concepts or design approaches. APBs and deviation reporting are required for all ACAT programs.

g. Test and Evaluation Master Plan (TEMP). The TEMP is the executive-level planning document required for a system that focuses on the overall structure, major elements, and objectives of the T&E program. The TEMP is consistent with the AS as well as the validated CDD, CPD, and ISP. It is a reference document used by the T&E community to generate detailed T&E plans and to ascertain schedule and resource requirements associated with a given system. The TEMP provides a roadmap for integrated simulation, test, and evaluation plans, schedules, and resource requirements necessary to accomplish the T&E program. The TEMP describes what testing (e.g., developmental test and operational test) is required, who will perform the testing, what resources will be needed, and what are the requirements for evaluation. It relates program schedule, test management strategy and structure, and required resources to critical operational issues; critical technical parameters; Measures of Effectiveness (MOE) and suitability; and MS decision points. While the PM has the overall responsibility, each T&E WIPT member contributes to the TEMP development and maintenance. The TEMP is initially developed at a system's first MS review and is updated before each subsequent MS, when the CDD/CPD/ISP has changed significantly, or when the APB has been breached. Upon approval, the TEMP serves as a contract between the CAPDEV, MATDEV and T&E community for executing the system's T&E program. The TEMP provides key management controls for T&E in support of the acquisition process.

h. Life Cycle Sustainment Plan (LCSP). LCSP spans a system's entire life-cycle, from the MSA phase to disposal. It translates force provider capability and performance requirements into tailored product support to achieve specified and evolving life-cycle product support availability, reliability, and affordability parameters. Life-cycle sustainment planning is considered during MSA, and matures throughout the TMRR phase. A LCSP is prepared for MS B. The planning is flexible and performance-oriented, reflecting an evolutionary approach, and accommodates modifications, upgrades, and re-procurement. The LCSP is part of the program's AS and is integrated with other key program planning documents. The LCSP is updated and executed during P&D and O&S phases. Life-cycle sustainment considerations include supply; maintenance; transportation; sustaining engineering; data management; configuration management; HSI; manpower, personnel, training, habitability, survivability, environment, safety (including explosives safety), and occupational health; protection of critical program information and anti-tamper provisions; supportability; and interoperability.

i. Manpower Estimate Report (MER). This Congressionally directed report documents the total number of personnel (military, civilian, and contractor) that are or will be needed to operate, maintain, support, and train for an ACAT I program upon full operational deployment. The validity of the MER is dependent upon force structure, personnel management, and readiness requirements, as well as the acquisition decision on the size of the buy (procurement).

# CAPABILITY REQUIREMENTS AND MATERIEL SYSTEM RESEARCH, DEVELOPMENT, AND ACQUISITION MANAGEMENT

## 10-62. Typical Waivers and Reports

a. Selected Acquisition Report (SAR). The SAR reports the status of total program cost, schedule, and performance; as well as program unit cost and unit cost breach information. For joint programs, the SAR reports the information by participant. Each SAR includes a full, life-cycle cost analysis for the reporting program. The SAR codifies policies for acquisition of supplies and services by executive agencies. The SAR is provided to Congress.

b. Defense Federal Acquisition Regulation Supplement (DFARS). The DFARS provides DOD specific acquisition regulations that DOD government acquisition officials – and those contractors doing business with DOD – must follow in the procurement process for goods and services.

c. Nunn-McCurdy unit cost breach report. A Nunn-McCurdy unit cost breach occurs when an MDAP experiences an increase of at least 15% in Program Acquisition Unit Cost (PAUC) or average Procurement Unit Cost (APUC) above the unit costs in the current APB or 30% from the original baseline, a SECDEF certification is required. Certification responsibility has been delegated to the USD (AT&L). Unit cost reporting is required by 10 USC 2433.

d. Live Fire Test & Evaluation (LFT&E) Report. The LFT&E is an independent OSD report to Congress that provides test results and assessment of realistic survivability testing on a covered major system, and realistic lethality testing on a major munition or missile program. Congress mandates this report.

e. Beyond Low-Rate Initial Production (LRIP) Report. This provides Congress with an assessment of the adequacy of IOT&E and whether the test results confirm the items are effective, suitable, and survivable for combat prior to the FRP decision to proceed beyond LRIP. Congress mandates this report.

f. Acquisition Decision Memorandum (ADM). The ADM documents the MDAs decision on the program AS goals, thresholds, and the exit criteria for the next phase of the program. The ADM is used to document the decision for all ACAT I, II, and III programs.

## Section XIII

### Major Sub-Processes within the Acquisition Process

#### 10-63. Test and Evaluation Process / Products

There are several major sub-processes that support the Defense Acquisition System (DAS). One of those major sub-processes is Testing and Evaluation (T&E).

a. All Army acquisition programs must be supported by a TEMP, that reflects an adequate and efficient T&E program. T&E is the principal tool with which progress in system development and acquisition is measured. T&E is structured to support the DAS and user by providing essential information to decision-makers, assessing attainment of technical performance parameters, and determining whether systems are operationally effective, suitable, and survivable for intended use. The primary reasons for conducting T&E are to facilitate learning, assess technical maturity and interoperability, facilitate integration into fielded forces, and confirm performance. Also, T&E can assess and reduce program risk (e.g., cost, schedule, technical feasibility, technical obsolescence, and software management). The primary product of the T&E sub-process is information (hard facts), plus an independent evaluation of all the credible data on a system, so that the MDA can make informed decisions.

b. The planning, programming, and budgeting for T&E begins early in the acquisition process, concurrent with coordination of the validated ICD. Early T&E integration is accomplished through the independent evaluator's involvement in the capability development team and the planning of the acquisition team within the T&E WIPT. The primary purpose of the T&E WIPT is to optimize the use of the appropriate T&E expertise, instrumentation, targets, facilities, simulations, and models to implement test integration, thereby reducing costs and decision risk to the Army. The primary product of the T&E WIPT is the TEMP. The Army Test and Evaluation Executive, within the office of the DUSA, is the TEMP approval authority for all ACAT I/IA, ACAT II, and any programs on the OSD T&E Oversight List prior to final OSD approval. The MDA approves TEMPs for ACAT II and III programs not on the OSD T&E Oversight List.

c. Continuous Evaluation (CE) is used to provide a continuous flow of information and data to decision-makers, MATDEV, and CAPDEVs. The data generated in early development phases is visible and maintained as the system moves into formal testing, thereby avoiding duplication of testing. Continuous evaluation continues through a system's post-deployment, to verify whether the fielded system meets or exceeds demonstrated performance and support parameters.

### 10-64. Developmental Testing and Operational Testing

a. DT encompasses models, simulation, and engineering tests that are used to verify that design risks are minimized, system safety is certified, achievement of system technical performance is substantiated, and to certify readiness for OT. DT generally requires instrumentation and measurements, is accomplished by engineers and technicians, is repeatable, may be environmentally controlled, and covers the complete spectrum of system capabilities. The PM designs DT objectives applicable to each phase and MS. Examples of key DTs are the LFT that is mandated for covered systems and the Production Qualification Test (PQT), the system-level test that ensures design integrity over the specified operational and environmental range.

b. OT is a field test of a system (or item) under realistic operational conditions with users who represent those expected to operate and maintain the system (or item) when fielded or deployed. Examples of key OTs are:

(1) Limited User Test (LUT). An LUT is a risk mitigation test normally conducted in the systems acquisition phase prior to MS C. Although not required by law, it is used to mitigate risk during follow-on OTs.

(2) IOT&E. It is conducted before the FRP decision and is structured to provide data to determine the operational effectiveness, suitability, and survivability of a system operated by typical users under realistic conditions (e.g., combat and representative threat).

(3) FOT&E. FOT&E may be necessary during (or after) production to refine the estimates made during the IOT&E, provide data to examine changes, and verify that deficiencies in materiel, training, or concepts have been corrected. A FOT&E provides data to ensure that the system continues to meet operational needs and that it retains its effectiveness in a new environment or against a new threat.

c. The Army's TSARC is a high-level centralized management forum that reviews and coordinates the resource commitment (e.g., personnel, instrumentation, and equipment), required to support the tests included in the Army's Five-Year Test Program (FYTP). The TSARC is chaired by CG, ATEC and operates under AR 73-1. When approved for inclusion in the FYTP, a program's TRP becomes the authority for tasking in the current and budget years. The TRP is the acquisition system's formal T&E resource planning and tasking document.

## Section XIV Integrated Product Support

### 10-65. Integrated Product Support Process

The second major sub-process in support of DAS is Integrated Product Support (IPS). TPF and the LCMC are also discussed in this section of the chapter.

a. IPS is a disciplined, unified, and interactive approach to the management and technical activities necessary to integrate logistics support into system and equipment design. IPS is the process used by the Army to implement the mandatory life-cycle logistics policies and procedures and includes all elements of planning, developing, acquiring, and supporting Army materiel throughout its life-cycle.

b. Supportability Integrated Product Team (SIPT).

(1) The SIPT is a working-level IPT to support both the capabilities development and system acquisition management processes. The CAPDEV proponent CoE establishes an SIPT at the DAS MSA phase for all potential ACAT I/II and selected ACAT III acquisition programs to coordinate overall IPS planning and execution. At MS B, or when the PM is assigned, the designated MATDEV Integrated Product Support Manager (IPSM) assumes responsibility to chair the SIPT.

(2) SIPT members develop PBL concepts and IPS program documentation and conduct supportability/tradeoff analyses to determine the optimum PBL strategy or IPS concepts. The SIPT make recommended IPS-related planning, programming, and execution decisions to the PM. The SIPT is a working body, and the roles and responsibilities of members are prescribed in the LCSP, formerly Supportability Strategy (SS). The SIPT must work with other functional groups, such as the T&E WIPT and the Training Support Work Group (TSWG) to ensure an integrated effort.

c. IPSM. The IPSM is established by the MATDEV prior to MS B or when a PM is assigned to serve as the focal point for all life-cycle management supportability actions related to the acquisition program. The IPSM assumes the responsibility to chair the SIPT from the CAPDEV.



## CAPABILITY REQUIREMENTS AND MATERIEL SYSTEM RESEARCH, DEVELOPMENT, AND ACQUISITION MANAGEMENT

d. PBL. PBL is the preferred Product Support Strategy (PSS) for weapon systems that employs the purchase of support as an integrated performance package designed to optimize system readiness. PBL objectives include optimizing total system availability while minimizing cost and logistics footprint. PBL is implemented on all Army ACAT programs where it is operationally and economically feasible. PBL is implemented on Army ACAT III programs at the discretion of the PM/PEO. A basic tenet of PBL is the use of high-level metrics that measures support outcomes both operationally and economically. Current overarching life-cycle metrics include: operational availability; mission reliability; cost per unit usage; logistics footprint; logistics response time; and total life-cycle cost per unit usage. PBL may be implemented on systems, subsystems, secondary items, components, assemblies, or subassemblies as well as processes that lead to business process improvements (for example, Lean or Six Sigma improvements on a depot line). PBL will meet performance goals for the system through a support structure based on performance agreements with clear lines of authority and responsibility, delineate outcome performance goals of weapon systems, ensure that responsibilities are assigned, provide incentives for attaining these goals, and facilitate the overall life-cycle management of system reliability, supportability, and total ownership costs. The PBL strategy must be addressed at each MDR and is tailored for each individual acquisition system with specific performance goals, roles, responsibilities that will be detailed in Performance-Based Agreements (PBA) prior to system fielding.

e. LCSP. LCSP documents the PM's plan for the sustainment strategy of an acquisition program. The LCSP is based upon the IPS framework (IPS elements) and defines how supportability analyses will be used throughout the systems engineering process to design and support the system. The LCSP is a standalone document which is submitted for Milestone Decision Authority (MDA) approval as an appendix to the AS beginning with MS B. The PM will also include a summary of the LCSP in the main body of the AS. The initial LCSP is prepared by the CAPDEV ILS lead for the system during the Materiel Solution Analysis Phase and is provided to the PM's IPSM or PSM upon establishment of the PM SIPT.

(1) The purpose of the LCSP is to methodically gather and review relevant logistics data assess alternative system design and support concepts using the SA, document decisions, coordinate plans, and execute the selected logistics support concept. The LCSP will serve as the official record to document the actions taken during the development and implementation of the IPS management process.

(2) The LCSP is used to maintain an audit trail of changes that affect:

(a) Support planning

(b) Support budgets, including the LCC estimate and reduction in total ownership costs initiatives

(c) Support concepts, support-related goals, and thresholds (including changes in definition)

(d) Impacts or changes on system readiness objective (SRO), support costs, and IPS objectives

(e) Strategy to achieve type classification-standard and Full Materiel Release (FMR) by FRP decision

(3) The LCSP for all ACAT levels is managed by the PM SIPT and approved by the MDA. The SIPT utilizes the acquisition strategy for its foundation to ensure supportability is integrated into the acquisition.

(4) The LCSP is updated by the PM; coordinated with CAPDEV, supporting LCMCs, Army Acquisition Logician, the technical and operational testers/evaluators, and other program participants; and will be available prior to MS B.

(a) When no PM exists prior to MS B, the PEO, who is assigned system responsibility, will lead the effort to develop the LCSP.

(b) In cases where there was not a CAPDEV IPS lead, the PEO (or PM if assigned) will develop the initial LCSP.

(c) Programs past MS B that do not have a LCSP will require one prior to MS C to address the IPS planning during development, production, fielding, and sustainment.

(5) The LCSP will be updated:

(a) Before MDRs

(b) When new program direction is received

(c) When programmatic or funding changes occur

(d) Prior to development of solicitation documents

(e) Prior to requesting a materiel release position from any agency

(f) Not more than three years from the previous update if there have been any changes to the program that may have logistical impacts

(g) When manpower, personnel, training, or logistics support plans change

## Section XV Army Human System Integration

### 10-66. Army Human System Integration

The third major sub-process in support of the DAS is the Army HSI program. HSI is the Army's application of the DOD HSI requirements in systems acquisition (DODD 5000.01 and DODI 5000.02), in compliance with Title 10. HSI, described in detail in AR 602-2, is the Army's program to ensure that Soldier performance is the central consideration in system design, development, and acquisition. HSI is the technical process of integrating the seven interdependent elements of manpower, personnel capabilities, training, human factors engineering, system safety, health hazards, and Soldier survivability. There are seven Army HSI domains—

a. **Manpower.** Manpower is the personnel strength (military and civilian) available to the Army. It refers to the consideration of the net effect of Army systems on overall human resource requirements and authorizations (spaces) to ensure that each system is affordable from the standpoint of manpower. It includes the analysis of the number of people (including contractors) needed to operate, maintain, and support each new system being acquired, including maintenance and supply personnel, and personnel to support and conduct training. It requires a determination of the Army manpower requirements generated by the system, comparing the new manpower needs with those of the old system(s) being replaced. If an increase in personnel is required to support a new (or modified) system, "bill payers" must be identified from existing personnel accounts.

b. **Personnel capabilities.** Personnel capabilities are military and civilians (including contractors) possessing the aptitudes, characteristics, and grades required to operate, maintain, and support a system in peacetime and war. Personnel refers to the ability of the Army to provide qualified people in terms of specific aptitudes, experiences, and other human characteristics needed to operate, maintain, and support Army systems. It requires a detailed assessment of the aptitudes that personnel must possess in order to complete training successfully, as well as operate, maintain, and support the system to the required standard. Iterative analyses must be accomplished for the system being acquired, comparing projected quantities of qualified personnel with the requirements of the new system, or any system(s) being replaced, and overall Army needs for similarly qualified people. Personnel analyses and projections are needed in time to allow orderly recruitment, training, and assignment of personnel in conjunction with system fielding.

c. **Training.** Considerations of the necessary time and resources required to impact the requisite knowledge, skills, and abilities to qualify Army personnel for operation, maintenance, and support of Army systems.

(1) It involves:

(a) Formulating and selecting engineering design alternatives that are supportable from a training perspective

(b) Documenting training strategies

(c) Determining resource requirements to enable the Army training system to support system fielding

(2) It includes analyses of the tasks that must be performed by the operator, maintainer, and supporter; the conditions under which the tasks must be performed; and the performance standards that must be met. Training is linked with personnel analyses and actions, because availability of qualified personnel is a direct function of the training process.

d. **Human factors engineering.** Human factors engineering is the technical effort to integrate design criteria, psychological principles, and human capabilities as they relate to the design, development, test, and evaluation of systems. The human factors engineering goals are:

(1) To maximize the ability of the Soldier to perform at required levels by eliminating design-induced error.

(2) To ensure materiel maintenance, support, and transport are compatible with the capabilities and limitations of the range of fully equipped Soldiers who would be using such materiel. Human factors engineering provides an interface between the HSI domains and system engineers. Human factors engineering supports the HSI goal of developing equipment that will permit effective Soldier-machine interaction within the allowable, established limits of training time, Soldier aptitudes and skill, physical endurance, physiological tolerance limits, and Soldier physical standards. Human factors engineering provides this support by determining the Soldier's role in the materiel system, and by defining and developing Soldier-materiel interface characteristics, workplace layout, and work environment.

# CAPABILITY REQUIREMENTS AND MATERIEL SYSTEM RESEARCH, DEVELOPMENT, AND ACQUISITION MANAGEMENT

e. System safety. System Safety involves the design features and operating characteristics of a system that serve to minimize the potential for human or machine errors or failure that cause injury and/or accidents.

f. Health hazards. Health hazards are the inherent conditions in the use, operation, maintenance, support, and disposal of a system (e.g., acoustical energy, biological substances, chemical substances, oxygen deficiency, radiation energy, shock, temperature extremes, trauma, and vibration), that can cause death, injury, illness, disability, or reduce job performance of personnel.

g. Soldier survivability. Soldier survivability within the context of HSI may refer to a military or a civilian.

(1) System. The characteristics of a system that can reduce fratricide, reduce detectability of the Soldier, prevent attack, if detected; prevent damage, if attacked; minimize medical injury, if wounded or otherwise injured; and reduce physical and mental fatigue.

(2) Soldier. Those characteristics of Soldiers that enable them to withstand (or avoid) adverse military action or the effects of natural phenomena that would result in the loss of capability to continue effective performance of the prescribed mission.

## 10-67. Human System Integration Objectives and Concept

a. The HSI program has three primary objectives:

(1) Optimize both the quantity and quality of the personnel needed for systems

(2) Design systems that are easily useable by Soldiers, safe to operate, cause no unnecessary health problems, and maximize Soldier survivability

(3) Ensure acceptable trade-offs are made among performance, design, and Soldier capabilities and limits

b. This ensures that Soldier readiness is not compromised by equipment that is difficult to use or maintain. The implementation of HSI impacts total system performance (both effectiveness and availability) by making explicit the role that Soldier performance plays and is shaped by design factors. HSI addresses the MPT resources needed to achieve the required performance and, where possible, indicates more affordable configuration of MPT resources.

c. The engineering design philosophy of HSI is focused on optimum system performance on the battlefield, which includes consideration of both Soldier and equipment capabilities and survivability. HSI is an option-oriented process as opposed to an objective-oriented process. The HSI process provides decision-makers information upon which to make trades in areas such as quality and numbers of people, training times, technology, conditions, standards, costs, survivability, safety, health hazard risks, design and interface features, and personnel assignment policy.

d. The body of HSI expertise, formerly known as the HSI joint working group, continues to function through the capability development team and IPT process, previously discussed. The HSI members of the capability development team transition to the HSI WIPT, when applicable. The purpose of this body is to:

(1) Assist the CAPDEV (or functional proponent) and PM to ensure HSI principles are applied to the system

(2) Provide HSI input to the MCDs

(3) Provide a tracking system and historical database of HSI issues

e. The Army's combat effectiveness and readiness depend on equipping our Soldiers with equipment that meets their needs and allows them to accomplish their assigned missions rapidly, accurately, and efficiently.

f. The Army Research Laboratory's Human Research & Engineering Directorate serves as the HSI focal point for coordinating domain support for CoEs' CDID capability development teams and IPTs.

## Section XVI Training Development

### 10-68. Training Development Overview

The fourth major sub-process in support of the DAS is training development.

a. Training development is a vital component of TRADOC's mission to prepare the Army for war. TRADOC is responsible for developing training and providing support for individual and unit training. This responsibility includes determining requirements for range, ammunition, and training devices and

## HOW THE ARMY RUNS

facilities, as well as education/training courses, products, and programs.

b. The Army's TD process, the Army Training and Education Development Process (TEDP), is a systematic approach to making training/education decisions. TEDP is a systematic, spiral approach to making decisions about collective, individual, and self-development training for the Army. The TEDP involves five training related phases: evaluation; analysis; design; development; and implementation. Evaluation is continuous throughout the TEDP process and the entire process must operate within a given set of resources. DOTMLPF-P drive training and TD capabilities-based requirements.

c. The Army's implementation of DAS is a complex, lengthy process and training development is embedded throughout the process. The capabilities development and system acquisition management process provide a structure for system management. Training impacts and costs are vital to system performance. Coordination between the CAPDEV, MATDEV, and TNGDEV must be close and continuous to develop and field a complete material system that meets the CDD requirements (previously discussed).

### 10-69. Systems Training Plan

a. The STRAP is the master training plan for a new, improved, or displaced materiel system. It establishes a basis for determining resources (manpower, equipment, facilities) to ensure training can be adequately conducted and supported. It outlines the development of the total training strategy for integrating a new system into the training base and gaining units; plans for all necessary training support, training products, and courses; and sets MSs to ensure the accomplishment of the training strategy. In addition, the STRAP supports development and validation of the system Materiel Requirements Documents (MRD) and establishes MSs for managing training development.

b. The STRAP is developed by the proponent TNGDEV, and is approved by the commanding general of the proponent TRADOC or non-TRADOC CoE.

### 10-70. Training Aids, Devices, Simulators and Simulations

a. TADSS are developed and acquired to support training at the unit and/or Combat Training Centers (CTC) and within the institutional training base.

(1) Training aids are instructional aids to enable trainers to conduct and sustain task-based training in lieu of using extensive printed material or equipment.

(2) Training devices are three-dimensional objects and associated computer software developed, fabricated, stand-alone, embedded, or appended and procured specifically for improving the learning process and to usually support the live fire training environment.

(3) Simulators are devices, computer programs, or systems that allow simulation of an essential training task and allow for skill development in that task by providing repeatable drills in a controlled assessed training situation. They include physical models, mock ups, and simulations of weapon systems that replicate major training requirements.

(4) Simulations are the representation of salient features, operations, or environment of a system, subsystem, or scenario that usually supports the constructive environment.

b. TADSS are categorized as either system or non-system.

(1) System TADSS are designed for use with a system, family-of-systems or item of equipment, including sub-assemblies and components. They may be stand-alone, embedded, or appended. They are funded (HQDA DCS, G-8, Equipping Program Evaluation Group (PEG)) and documented as part of the weapon system they support. The weapon system PM is responsible to procure the system TADSS.

(2) Non-Standard Training Aids, Devices, Simulations, and Simulators (NSTD) are designed to support general military training and non-system specific training requirements. They are funded (HQDA DCS, G-3/5/7, Training PEG) and documented as a separate program under the Training Mission Area (TMA). The PEO Simulation, Training, and Instrumentation is normally responsible to procure and develop non-system TADSS. Stand-alone CDDs and CPDs, with supporting STRAPs are developed by the TNGDEV.

### 10-71 Contracting

a. The Contracting Officer (KO): Authority to enter into, administer, and terminate contracts and make related determinations and findings. Responsible for ensuring performance of all necessary actions for effective contracting, ensuring compliance with the terms of the contract. He ensures the requests for approval of acquisition plans are in accordance with the thresholds identified in DFARS can bind Government to a specific dollar amount.

## CAPABILITY REQUIREMENTS AND MATERIEL SYSTEM RESEARCH, DEVELOPMENT, AND ACQUISITION MANAGEMENT

b. The Contracting Officer's Representative (COR): The is the primary Government official responsible for ensuring compliance with contractual agreements, designated by the KO. The COR should have extensive knowledge of the goods and services being procured. He has no authority to make any commitments or changes that affect price, quality, quantity, delivery, or other terms and conditions of the contract nor in any way direct the contractor or its subcontractors to operate in conflict with the contract terms and conditions. He provides technical direction, contractor liaison, quality assurance, inspection / acceptance.

c. Common Types of Contracts:

(1) Fixed Price Contracting Options:

(a) Firm Fixed Price

- Price fixed regardless of contractors actual cost experience

- Typical use: Commercial Supplies and Services

(2) Fixed Price with Award Fee

- Award unilaterally determined by the government based on subjective evaluation of performance (i.e. quality, timeliness, cost effectiveness).

- Typical use: Performance based service contracts

(3) Fixed Price with Economic Price Adjustment

- Agreed upon economic market condition(s) may fluctuate and trigger a price change

- Typical Use: Long term contracts for commercial supplies thru periods of high inflation

(4) Fixed Price - Redeterminable

- Amount is determined subsequent to most or all of the specified performance; as it expires, negotiation will determine costs in an extension of the contract

- Typical Use: Long-term production of parts for major systems

(5) Fixed Price Incentive

- A "profit" adjustment is based on a predetermined formula in relation to *target cost*

- Typical use: Production of a major system based on a prototype

d. Cost Reimbursement Contracting Options:

(1) Cost Plus Fixed Fee

- Entitled to a fixed amount of profit

- Typical use: Research Study

(2) Cost Plus Incentive Fee

- Fee (profit) adjusted based on contractors actual cost experience in relation to "target cost"

- Typical use: Research & Development of the prototype for a major system

(3) Cost Plus Award Fee

- Award unilaterally determined by government based on subjective evaluation of performance (i.e. quality, timeliness, cost effectiveness)

- Typical use: Large scale Research Study

(4) Cost Sharing

- Contractor pays portion of allowable costs / NOT paid a profit

- Typical use: Joint Research with Educational Institutions

(5) Time and Materials (T&M)

- A ceiling price with negotiated "per-hour" labor rate that covers overhead & profit

- Provides for reimbursement of direct material (parts, supplies) costs

- Typical use: Emergency repairs on heating plants and aircraft engines

e. Other types of contracts include:

(1) Definite Quantity Contracts

(2) Requirements Contracts

(3) Indefinite Quantity Contracts. The appropriate type of Indefinite Delivery Contract can be used to acquire supplies and/or services when the exact times and/or exact quantities of future deliveries are not known at the time of contract award (see fig. 10-25).

## Typical Contracting Categories

### Fixed Price:

- Requirements (products & services) well defined
- Preferred type (NDAA FY17)
- Contractor assumes higher cost risk
- Total price for work is set

### Cost Reimbursement (Cost Plus):

- Requirements (products & services / R&D) not well defined
- Government assumes higher cost risk
- Government buys contractors best effort
- Contractor entitled to recover allowable costs
- Allows government flexibility

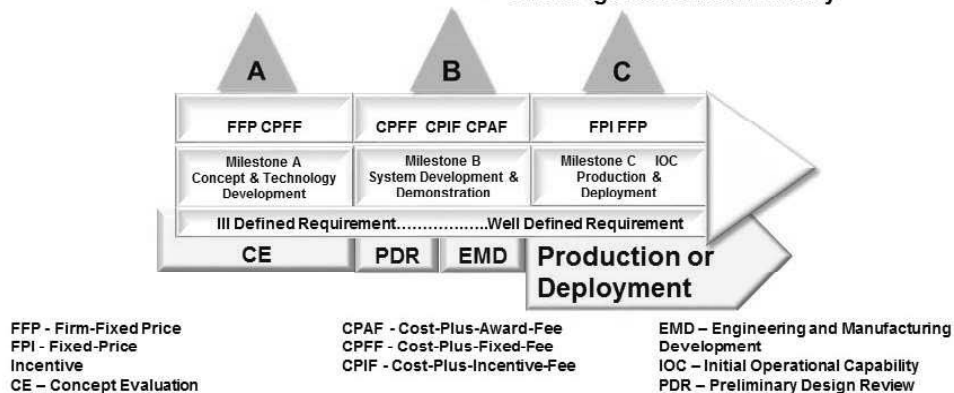

Figure 10-25. Types/Categories of Contracts

## Section XVII

### Joint Warfighting Assessment and Network Integration Evaluation Processes

**10-72. Joint Warfighting Assessment (JWA).** JWA is the Army’s methodology for shifting of the way it develops new technologies for the battlefield. It replaces one of the two annual Network Integration Evaluations with the broader Joint Warfighting Assessment. The JWA will focus on innovation and developing partnerships with industry and academia to help design and mature the Army’s tactical network efficiently and focus on innovative technologies and new concepts, Force modernization, interoperability for joint and multinational forces and readiness among those forces using live, virtual and constructive, or LVC, technology, which incorporates virtual training environments and allows far-flung participants to join the exercise (see Fig. 10-26).

### 10-73. Network Integration Evaluation

a. Acquisition, testing, assessment/evaluation, and fielding processes typically have taken several years to complete, which can take longer than several technology maturation cycles. Funding and timelines for Network-related programs were rarely aligned. Capabilities were fielded piecemeal and integration with existing technology was sometimes left to the user. Therefore, many recently fielded systems did not benefit from the latest mature technologies nor did they respond to the latest Army capabilities needs. This approach greatly challenged interoperability and training. The Army, however, had implemented improved business practices, namely Software Blocking (SB) and Unit Set Fielding (USF) to address specific problems, but did not holistically focus on the Army Enterprise Network.

b. To achieve its network objectives, the Army is radically changing the way it delivers capability to its operating forces from start (need or gap identification) to finish (fielding and sustainment). Consistent with Public Law 111-84 (National Defense Authorization Act (NDAA) FY2010), Section 804, and the OSD

# CAPABILITY REQUIREMENTS AND MATERIEL SYSTEM RESEARCH, DEVELOPMENT, AND ACQUISITION MANAGEMENT

Report to Congress, the VCSA directed the ARSTAF to implement agile business solutions that would address current network acquisition shortcomings and bring efficiency, effectiveness, and affordability to these otherwise burdensome processes. Successful implementation of this process will result in early and continuous delivery of needed capabilities to leaders and Soldiers throughout the force with particular focus on the BCT. In order to ensure that new capability solutions are integrated with the network, constant adaptability and frequent changes are essential due to the swift maturation cycle of information technology and the rapid reaction required by the Army.

## Joint Warfighting Assessment Concept

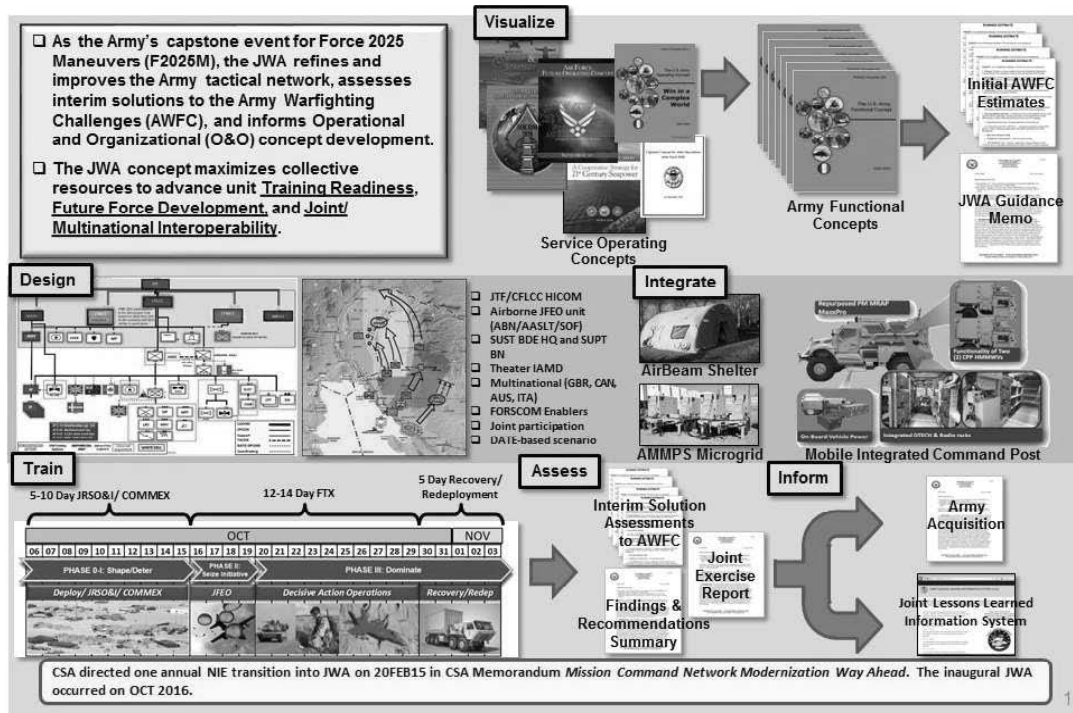

**Figure 10-26. Joint Warfighting Assessment Concept**

c. Soldier feedback and lessons learned from past NIEs have allowed the Army to mature certain programs, restructure or terminate others and re-allocate resources to other priorities as well as deliver on non-network and non-material solutions. Capability Sets was integrated, refined, and validated through the NIEs which reduced the integration burden on the Soldiers in the field while helping develop Tactics, Techniques, and Procedures (TTPs) for using the network in the field. And Programs of Record (POR) network systems that have implemented changes based on Soldier feedback during NIEs have lead to better performing and more user-friendly systems. NIEs are conducted annually (see Fig 10-27).

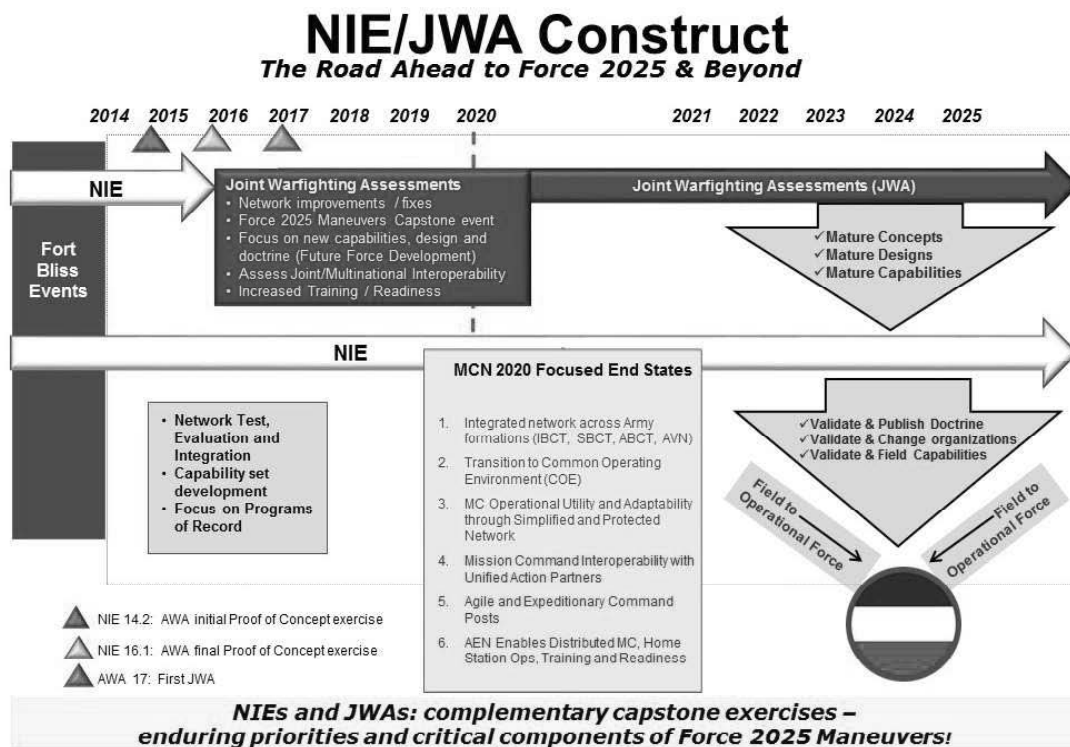

Figure10-27. NIE/JWA Construct

**Section XVIII  
Acquisition Resource Management**

**10-74. Appropriations**

The “color of money,” or kind of appropriation, is an important factor in system acquisition management. An appropriation provides limited amounts of budget authority that agencies may obligate during a specific time period for the purposes specified in the legislation that provides the appropriation. Budget Authority provides the power to obligate the U.S. government to pay a bill. In general, a particular appropriation can be expended only for specified activities and budget authority cannot be moved from one appropriation to another without transfer authority. Acquisition management involves at least two to four appropriations. The two-year RDT&E appropriation provides funds for research, design engineering, prototype production, LRIP for OT, and T&E activities in the course of developing a materiel system. The three-year procurement appropriation provides funds for procuring materiel that has been fully tested and type classified. Procurement funds are used to procure LRIP for initial spares, support, and training equipment. The one-year Operations and Maintenance, Army (OMA) appropriation, provides funds for retiring and retrograding the old equipment being replaced; for repairing systems after fielding; for fuel and ammunition for training and operations; for periodic system rebuild; for training both system operators and maintainers, except new equipment training; and, in general, anything else to keep a system in the field and operating. Some systems may require five-year MILCON appropriated funds for the construction of special facilities required for fielding that system. The period of years identified for each appropriation refers to the time period that the appropriation is available to be obligated.



# CAPABILITY REQUIREMENTS AND MATERIEL SYSTEM RESEARCH, DEVELOPMENT, AND ACQUISITION MANAGEMENT

## 10-75. Program and Budget Process

Funds of the correct amount and appropriation must be planned and programmed into the Army budget, in general, two years before they are needed. In the program and budget process, funding requests are initiated and reviewed annually. Congress appropriates funds for RDT&E and Procurement as part of the annual Defense Appropriation Act. The RDT&E and procurement budget requests must first be approved by DOD, submitted to Congress by the President, and then be authorized and appropriated in two separate Congressional actions before any money can be spent. In the year of budget execution, the Army may reprogram funds, except for Congressional-interest items, within an appropriation subject to budget authority dollar limits or in excess of dollar limits with prior Congressional approval. Below \$10 million of RDT&E and below \$20 million of procurement may be reprogrammed from a lower priority program to a higher priority program without prior Congressional approval. The PM is responsible for planning and programming the RDT&E and procurement funds to cover a program, and the MILCON funds, when required. The PM is responsible for programming all life-cycle system costs for the system, while the system remains under PM management control. This includes programming for out-year sustaining resources, as well as RDT&E and procurement. Once the management responsibility transitions to the AMC LCMCs, it becomes that command's responsibility to continue the depot-level sustaining program. The field user Army command is responsible to program day-to-day system below-depot operational support. The field user Army command is responsible for planning and programming of OMA funds needed to ensure continued readiness of the fielded system. Responsibility for planning and programming funds for product improvements and sustaining supply spare parts is complex and divided between the LCMCs and the field Army command.

## 10-76. Research, Development, Testing, and Evaluation Appropriation Activities

To assist in the overall planning, programming, budgeting, and managing of the various R&D activities, the RDT&E appropriation is divided into seven R&D budget activities. These categories are used throughout DOD. The current RDT&E budget activities are as follows:

- a. Budget Activity 1 – Basic Research. Basic research includes all efforts and experimentation directed toward increasing fundamental knowledge and understanding in those fields of the physical, engineering, environmental, and life sciences related to long term national security needs.
- b. Budget Activity 2 – Applied Research. This activity translates promising basic research into solutions for broadly defined military needs, short of development projects. This type of effort may vary from systematic mission-directed research, which is beyond that in Budget Activity 1, to sophisticated breadboard hardware, study, programming, and planning efforts that establish the initial feasibility and practicality of proposed solutions to technological challenges. These funds are normally applied during the MSA phase of the DAS life-cycle.
- c. Budget Activity 3 – Advanced Technology Development. This activity includes all efforts that have moved into the development and integration of hardware for field experiments and tests. The results of this type of effort are proof of technological feasibility and assessment of operability and production rather than the development of hardware for Service use. These funds are normally applied during the TMRR phase of the DAS life-cycle.
- d. Budget Activity 4 – Advanced Component Development and Prototypes. This budget activity includes all efforts necessary to evaluate integrated technologies in as realistic an operating environment as possible, to assess the performance or cost reduction potential of advanced technology. These funds are normally applied during TMRR, but could be applied throughout the acquisition life-cycle.
- e. Budget Activity 5 – System Development and Demonstration. This budget activity includes those projects in system development and demonstration, but not yet approved for LRIP at MS C. These funds are normally applied during the EMD phase of the DAS life-cycle.
- f. Budget Activity 6 – RDT&E Management Support. Includes efforts directed toward support of RDT&E installations or operations required for use in general R&D and not allocable to specific R&D missions. Included are technical integration efforts, technical information activities, space programs, major test ranges, test facilities and general test instrumentation, target development, support of operational tests, international cooperative R&D, and R&D support.
- g. Budget Activity 7 – Operational System Development. This activity includes R&D efforts directed toward development, engineering, and test of changes to fielded systems or systems already in

## HOW THE ARMY RUNS

procurement which alter the performance envelopes. Operational system development may include OT costs.

### 10-77. Procurement Appropriations

Procurement is used to finance investment items, and covers all costs integral and necessary to deliver a useful end item intended for operational use or inventory. The Army budget includes five separate procurement appropriations:

- a. Aircraft Appropriation. Aircraft procurement includes the procurement of aircraft, aircraft modifications, spares, repair parts, and related support equipment and facilities.
- b. Missile Appropriation. Missile procurement includes the procurement of missiles, missile modifications, spares, repair parts, and related support equipment and facilities.
- c. Weapons and Tracked Combat Vehicles (WTCV) Appropriation. WTCV procurement includes tracked and combat vehicles, weapons, other combat vehicles, and repair parts.
- d. Ammunition Appropriation. Ammunition procurement includes procurement of ammunition end items, ammunition production base support, and ammunition demilitarization.
- e. Other Procurement, Army (OPA) Appropriation. OPA covers four major categories:
  - (1) Tactical and support vehicles.
  - (2) Communications and electronic equipment.
  - (3) Other support equipment.
  - (4) Initial spares.

### 10-78. Military Construction Appropriation

MILCON funds the cost of major and minor construction projects such as facilities. Major or specified military construction projects exceed \$2.0M and require congressional line-item authorization. Unspecified military construction projects are \$2.0M or less, but can be increased to \$3M if the project is intended to correct a life, health, or safety deficiency. Each military department receives an appropriation for minor military construction. The military department Secretary controls expenditure of minor military construction funds and is required to notify Congress of minor military construction projects that exceed \$750K. A 21-day waiting period is required after notification before work begins. Project costs include architecture and engineering services, construction design, real property acquisition costs, and land acquisition costs necessary to complete the construction project. The OMA appropriation can be used to fund unspecified minor military construction projects up to \$750K or up to \$1.5M, if the project is intended to correct a life, health, or safety deficiency.

### 10-79. Operations and Maintenance Appropriation

OMA finances those things that derive benefits for a limited period of time, such as expenses, rather than investments. Examples are Headquarters operations, civilian salaries, travel, fuel, minor construction projects of \$750K or less, expenses of operational military forces, training and education, recruiting, depot maintenance, purchases from Defense Working Capital Funds, and base operations support.

## Section XIX

### Summary, Key Terms, and References

#### 10-80. Summary

a. This chapter provided a basic introduction to the management process, organization, and structure of the JCIDS and system acquisition management process. Through the chapter description, the reader should have gained an appreciation of the logic of the process, its organization and management, including recent changes. This chapter highlights the current basic DOD and Army policies for capabilities development, materiel systems acquisition, and descriptions of capabilities development and system acquisition managers.

b. Difficult decisions, overseas contingency operations, a scarcity of dollar resources, and honest differences of opinion cause disruptions and delays. It is unlikely that there will be total agreement on the best technical approach to satisfy a need—or, indeed, on the need itself. The annual budget cycle and budget constraints almost ensure that some projects will not be funded at the level desired—if at all. Tests are not always successful. Estimates of time, costs, effectiveness, and technical feasibility are

# CAPABILITY REQUIREMENTS AND MATERIEL SYSTEM RESEARCH, DEVELOPMENT, AND ACQUISITION MANAGEMENT

often “wide of the mark” for complex systems. After all, they are estimates that are projected well into the future based on sketchy data. These real-world problems reinforce the fact that capabilities development and system acquisition management are complex processes of great importance to national defense. Capabilities development and system acquisition can be a host of new and effective weapons systems, where effective management and professionalism can make the difference in overseas contingency operations. As with any activity involving the use of scarce resources to meet organizational goals and objectives, the people involved—the capability developers, acquisition managers and the Soldier users and maintainers—constitute the most vital link to mission accomplishment.

## 10-81. Key Terms

a. *Capabilities Developer*. A person who is involved in analyzing, determining, prioritizing, and documenting requirements for doctrine, organization, training, materiel, leadership and education, personnel, facilities, and policy (DOTMLPF-P) implications within the context of the force development process. Also responsible for representing the end user during the full development and lifecycle process and ensures all enabling capabilities are known, affordable, budgeted, and aligned for synchronous fielding and support. The CAPDEV is the command or agency that formulates warfighting requirements for DOTLMPF-P. The acronym CAPDEV may be used generically to represent the user and user maintainer community role in the materiel acquisition process (counterpart to generic use of MATDEV) (TRADOC Reg 71-20, 28 Jun 13).

b. *Capabilities Development*. The analysis, determination, prioritization, and documentation of requirements for doctrine, organization, training, materiel, leadership and education, personnel, facilities, and policy implications within the context of the force development process (TRADOC Reg 71-20, 28 Jun 13).

c. *Document Integrator*. Ensures that requirements and authorization documents meet approved Army force programs and link requirements, planned or programmed force structure actions, and the documentation processes (FM 100-11, 15 Jan 98, RESCINDED).

d. *Force Development*. The process of determining Army doctrinal, leader development, training, organizational, Soldier development, and materiel requirements and translating them into programs and structure, within allocated resources, to accomplish Army missions and functions (AR 71-32, DRAFT).

e. *Force Modernization*. The process of improving the Army's force effectiveness and operational capabilities through force development and integration (AR 5-22, 25 Mar 11).

f. *Materiel Developer*. The Research, Development, and Acquisition command, agency, or office assigned responsibility for the system under development or being acquired. The term may be used generically to refer to the Research, Development, and Acquisition community in the materiel acquisition process (counterpart to the generic use of CAPDEV) (PROPOSED, derived from AR 71-32, DRAFT).

g. *Materiel Development*. The research and development, production, and fielding of a new materiel system (DAU Website).

h. *Synchronization Staff Officer*. The Army G-8 SSO is charged with the synchronization of the JCIDS, force structure, DAS, PPBE and equipment allocation processes in support of recommending an affordable equipment modernization investment strategy that best balances approved equipment modernization requirements and available fiscal resources to develop, procure, field and sustain material capabilities needed to meet ACP directed equipping objectives. In doing so, the SSO is a member of the force development team consisting of: The G-8 Requirements Staff Officer (RSO); the G-3/5/7 Organizational Integrator (OI); the NGB and OCAR System Integrator (SI); the Department of the Army System Coordinator (DASC); and, the ASC (LMI) Material Integrator (MI). As a member of this force development team, the SSO is not an acquisition system/program advocate, but rather, facilitates informed HQDA decision making that balances approved equipment modernization requirements and available fiscal resources in order to equip the force to meet Army Title 10 mission requirements.

i. *System Integrator*. The coordinator for determining requirements, assuring operational and organizational documentation, coordinating, planning, and programming fielding, and recommending resourcing priorities for designated functional areas or specific materiel systems (FM 100-11, 15 Jan 98, RESCINDED).

j. *Training Developer*. The Army agency that determines requirements for a system's training subsystem and formulates, develops, and documents associated training concepts, strategies, plans, and required training support. IAW AR 71-9 is a subset of and included within capability developer; serves as the user's representative during development and acquisition of a system's training subsystem (TRADOC

## HOW THE ARMY RUNS

Reg 71-20, 28 Jun 13).

k. *Training Development*. The process of developing, integrating, prioritizing, resourcing and providing quality control/quality assurance of the Army's training and education concepts, strategies and products to support the Army's training and education of Active Army and Reserve component Soldiers, Civilians and units across the institutional, self-development and operational training domains (AR 350-1, 19 Aug 14).

### 10-82. References

- a. 2013 Army Planning Guidance.
- b. Army G-8 Standard Operating Procedures (SOP) for Joint Capabilities Integration and Development System (JCIDS) Document Review Staffing and Affordability Assessments, Mar 2011.
- c. Army Materiel Command Logistics Support Activity (LOGSA) Pamphlet 700-3, Total Package Fielding (TPF).
- d. Army Regulation 350-1, Army Training and Leader Development, 18 Dec 2009.
- e. Army Regulation 5-22, The Army Force Modernization Proponent System, (Rapid Action Revision (RAR), 25 Mar 2011.
- f. Army Regulation 525-29, Army Force Generation, 14 Mar 2011.
- g. Army Regulation 602-2, Manpower and Personnel Integration (MANPRINT) in the System Acquisition Process, 1 Jun 2001.
- h. Army Regulation 700-127, Integrated Product Support, Oct 2016.
- i. Army Regulation 700-142, Type Classification, Materiel Release, Fielding, and Transfer, Sep 2016.
- j. Army Regulation 70-1, Army Acquisition Policy, 22 Jul 2011.
- k. Army Regulation 71-9, Warfighting Capabilities Determination, 28 Dec 2009.
- l. Army Regulation 73-1, Test and Evaluation Policy, 16 November 2016.
- m. Army Standard Operating Procedures (SOP) for Agile Capabilities Life-cycle Process, 7 Aug 2012.
- n. Capstone Concept for Joint Operations (CCJO), Joint Forces 2020, 10 Sep 2012.
- p. CJCSI 3010.02C, Joint Concept Development and Experimentation (JCD&E), 15 Jan 2012
- q. CJCSI 3170.011, Joint Capabilities Integration and Development System (JCIDS) Manual, 23 Jan 2015 is found online at [https://www.intelink.gov/wiki/JCIDS\\_Manual](https://www.intelink.gov/wiki/JCIDS_Manual).
- r. CJCSI 5123.01G, Charter of the JROC, 12 Feb 2015.
- s. DA Pamphlet 700-142, Instructions for Type Classification, Materiel Release, Fielding, and Transfer, Sept 2016.
- t. DA Pamphlet 700-56, Logistics Supportability Planning and Procedures in Army Acquisition, 5 Dec 2005.
- u. DA Pamphlet 70-3, Army Acquisition Procedures, 28 Jan 2008.
- v. DA Pamphlet 73-1, Test and Evaluation in Support of Systems Acquisition, 30 May 2003.
- w. Defense Acquisition University (DAU), Introduction to Defense Acquisition Management, 10th Edition, Aug 2010.
- x. Defense Strategic Guidance (DSG), Jan 2012.
- y. DOD Directive 5000.01, The Defense Acquisition Management System, 12 May 2003 (certified current as of 20 Nov 2007).
- z. DOD Directive 5000.52, Defense Acquisition Education, Training and Career Development Program, 25 Oct 1991.
  - aa. DOD Directive 5000.71, Rapid Fulfillment of CCDR Urgent Operational Needs, 24 Aug 2012.
  - bb. DOD Directive-Type Memorandum (DTM) 09-027, Implementation of the Weapon Systems Acquisition Reform Act of 2009 (Public Law 111-23), 4 Dec 2009.
  - cc. DOD Instruction 5000.02, Operation of the Defense Acquisition System, 7 Jan 2015, Incorporating Change 2, effective 2 Feb 2017.
  - ee. Federal Acquisition Streamlining Act of 1994, 13 Oct 1994.
  - ff. HQ TRADOC, ARCIC Memorandum, Subject: Implementing Cost-Benefit Analysis (CBA) Guidance for JCIDS Capabilities Documents, 15 Jun 2012.
  - gg. HQ TRADOC, Army Capabilities Integration Center (ARCIC) Writer's Guide Initial Capabilities Document (ICD) Instruction Guide, version 3.2, 1 Nov 2016.
  - hh. HQ TRADOC, Army Capabilities Integration Center (ARCIC) Capability Development Document (CDD) Writer's Guide, version 3.6, 30 Aug 2017.
  - ii. HQ TRADOC, Army Capabilities Integration Center (ARCIC) Capability Production Document (CPD) Writer's Guide, version 3.5, 1 Nov 2016.

## CAPABILITY REQUIREMENTS AND MATERIEL SYSTEM RESEARCH, DEVELOPMENT, AND ACQUISITION MANAGEMENT

- jj. HQ TRADOC, Army Capabilities Integration Center (ARCIC) DOTmLPF Integrated Capabilities Recommendation (DICR) Guide, 25 May 2011.
- kk. HQ, TRADOC Memorandum, Subject: Doctrine 2015 Guidance, 23 Aug 2011.
- ll. HQDA DCS, G-3/5/7, ECOP User's Guide, version 2.3, 20 Jul 2011.
- mm. HQDA DCS, G-8 Army Equipping Strategy, 27 Jul 2011.
- nn. HQDA DCS, G-8 Memorandum, Subject: Conduct of Review and Affordability Assessments for Joint Capabilities Integration and Development System (JCIDS) and other Emerging Equipment Requirement Documents, 4 Mar 2011.
- oo. HQDA G-3/5/7, The 2012 Army Campaign Plan, 1 Jun 2012.
- pp. HQDA, 2010 Army Science and Technology Master Plan, 14 Jul 2010.
- qq. HQDA, 2013 Army Posture Statement.
- rr. HQDA, 2013 Weapon Systems Handbook.
- ss. HQDA, Assistant Secretary of the Army for Financial Management and Comptroller (ASA(FM&C)) Memorandum, Subject: Cost-Benefit Analysis Guidance and Training, 1 Feb 2010.
- tt. HQDA, Deputy Assistant Secretary of the Army Cost and Economics (DASA(CE)) Memorandum, Subject: U.S Army Cost-Benefit Analysis Guide, version 1.0, 12 Jan 2010.
- uu. HQDA, The United States 2014 Army Equipment Modernization Plan, 13 May 2013.
- vv. "Initial Message to the Army," General Mark A. Milley, 26 Aug 15.
- ww. JCS J-8 Force Structure, Resources, and Assessments Directorate, Capabilities-Based Assessment (C-BA) User's Guide, version 3, Mar 2009.
- xx. JROC Memorandum (JROCM), Subject: JROC, and JCIDS Changes, 3 Feb 2012.
- yy. National Defense Strategy (NDS), 16 Jun 2008.
- zz. National Military Strategy (NMS), 8 Feb 2011.
- aaa. National Security Strategy (NSS), May 2010.
- bbb. Office of the Under Secretary of the Army and Vice Chief of Staff, Army Memorandum, Subject: Cost-Benefit Analysis to Support Army Enterprise Decision Making, 30 Dec 2009.
- ccc. SECARMY Memorandum, Subject: Army Directive 2010-07, Non-Standard Equipment Interim Policy, 4 Aug 2010.
- ddd. The Defense Acquisition Workforce Improvement Act (DAWIA), Title 10 USC Sections 1701-1764, Defense Acquisition Workforce Improvement Act of 1990, as amended by Section 808, Public Law (PL) No. 106-398, National Defense Authorization Act for Fiscal Year 2001, October 30, 2000: Section 824, PL No. 107-107, Dec 28, 2001.
- eee. TRADOC Army Capabilities Integration Center (ARCIC), Capabilities-Based Assessment Guide, Version 3.1, 10 May 2010.
- fff. TRADOC Pamphlet 525-3-0, The U.S. Army Capstone Concept (ACC), 19 Dec 2012.
- ggg. TRADOC Pamphlet 525-3-1, The U.S. Army Operating Concept (AOC) 2016-2028, version 1.0, 19 Aug 2010.
- hhh. TRADOC Regulation 350-70, Army Learning Policy and Systems, 8 Dec 2011.
- iii. TRADOC Regulation 71-20, Concept Development, Capabilities Determination, and Capabilities Integration, Oct 2014.
- jjj. USD(AT&L) Memorandum, Subject: Configuration Steering Boards, 30 Jul 2007.
- kkk. USD(AT&L) Memorandum, Subject: Prototyping and Competition, 19 Sep 2007.
- lll. Weapon Systems Acquisition Reform Act of 2009 (Public Law 111-23), 22 May 2009.
- mmm. DA PAM 700-127 Integrated Product Support Procedures, 8 Oct 2014.

**This page is intentionally left blank**

## Chapter 11

### Logistics

#### Section I Introduction

##### 11-1. Chapter Content

This chapter provides an executive overview of the nature and structure of the Army's national and theater logistics systems and includes: key concepts and definitions; the principles of logistics; selected logistics terms; and the Army's national logistics organizations' roles and responsibilities— Assistant Secretary of the Army (Acquisition, Logistics, and Technology) ASA(ALT), Army G-4, Army G-8, and Army Materiel Command (AMC). The chapter underscores other national logistics organizations and Department of Defense (DOD) agencies that directly impact Army sustainment: U.S. Army Corps of Engineers (USACE); U.S. Army Combined Arms Support Command (CASCOM); the Army and Air Force Exchange Service (AAFES); Defense Logistics Agency (DLA); and the Defense Contract Management Activity (DCMA).

##### 11-2. Key Concepts and Definitions

a. **Fundamentals of Sustainment.** For the Army, sustainment is the provision of logistics, personnel services, and health service support necessary to maintain operations until successful mission completion (ADP 4-0). This is accomplished through the integration of national and global resources and ensures Army forces are physically available and properly equipped, at the right place and time, to support the Combatant Commander (CCDR). The concept leverages multinational and Host Nation Support (HNS), Operational Contract Support (OCS), and other available capabilities to minimize overburdening of military resources while maintaining a quality Army. Army sustainment is based on an integrated process (e.g., people, systems, materiel, health services, and other support) inextricably linking sustainment to operations. The concept focuses on building a combat ready Army, delivering capabilities to the CCDR as part of the joint force, and sustaining combat power across the depth of the operational area with unrelenting endurance.

b. **Logistics.** Logistics is planning and executing the movement and support of forces. (FM 4-95). Logistics involves both military art and science. Knowing when and how to accept risk, prioritizing a myriad of requirements, and balancing limited resources all require military art while understanding equipment and system capabilities and limitations incorporates military science. Logistics integrates strategic, operational, and tactical support of deployed forces while scheduling the mobilization and deployment of additional forces and materiel. Army logistics include the following—

(1) **Maintenance.** Maintenance is all actions taken to retain materiel in a serviceable condition or to restore it to serviceability. The Army's two levels of maintenance are field maintenance and sustainment maintenance (ATP 4-33). Maintenance is necessary for endurance and performed at the tactical through strategic levels of war.

(a) Field maintenance is repair and return to user and is generally characterized by on-(or near) system maintenance, often utilizing line replaceable unit, component replacement, battle damage assessment, repair, and recovery (ATP 4-33). It is focused on returning a system to an operational status. Field level maintenance is not limited to removal and replacement of materiel, but also provides adjustment, alignment, and fault/failure diagnoses. Additionally, Field maintenance includes battlefield damage and repair tasks performed by either the crew or support personnel to maintain a system in an operational state.

(b) Sustainment maintenance is generally characterized as “off system” and “repair rear” (ATP 4-33). The intent is to perform commodity-oriented repairs on all supported items to one standard that provides a consistent and measurable level of reliability. Off-system maintenance consists of overhaul and manufacturing activities designed to return components, modules, assemblies, and end items to the supply system or to units, resulting in extended or improved operational life expectancies.

(2) *Transportation.* Army transportation units play a key role in facilitating endurance. Transportation units move forces, equipment, and supplies from ports to points of need and retrograde materiel as required. Transportation operations encompass the employment of a wide range of capabilities needed to allow joint and Army commanders to conduct operations. Important transportation functions are movement control, intermodal operations (terminal and mode), and container management.

(a) Movement control is the dual process of committing allocated transportation assets and regulating movements according to command priorities to synchronize distribution flow over ground, air, and sea lines of communications (LOCs) to sustain land forces. Movement control balances requirements against capabilities and requires continuous synchronization to integrate military, host nation, and commercial movements by all modes of transportation to ensure seamless transitions from the strategic through the tactical level of an operation. It is a means of providing commanders with situational awareness to control movements in their operational area. Movement control responsibilities are imbedded in an infrastructure that relies on planning and execution coordination to ensure transportation assets are used efficiently while ensuring LOCs are deconflicted to support freedom of access for military operations.

(b) Intermodal operations is the process of using multiple modes (air, sea, highway, rail) and conveyances (truck, barge, containers, pallets) to move troops, supplies and equipment through expeditionary entry points and the network of specialized transportation nodes to sustain land forces. It uses movement control to balance requirements against capabilities and capacities to synchronize terminal and mode operations ensuring an uninterrupted flow through the transportation system. It consists of facilities, transportation assets and materiel handling equipment required to support the deployment and distribution enterprise. Terminal operations consist of the receiving, processing, and staging of passengers; the receipt, transit storage and marshalling of cargo; the loading and unloading of transport conveyances; and the manifesting and forwarding of cargo and passengers to a destination (JP 4-01.5). Terminal operations are a key element in supporting operational reach and endurance. They are essential in supporting deployment, redeployment and sustainment operations. There are three types of terminals: air, water, and land. Mode operations are the execution of movements using various conveyances (e.g., truck, lightering, railcar, and aircraft) to transport cargo. It includes the administrative, maintenance, and security tasks associated with the operation of the conveyances.

(c) Container management is the process of establishing and maintaining visibility and accountability of all cargo containers moving within the Defense Transportation System (DTS). In theater, container management is conducted by commanders at the operational and tactical levels. The Theater Sustainment Command (TSC) distribution management center coordinates intermodal operations with the movement control battalion at transportation, storage, and distribution nodes. The TSC maintains information on the location and status of containers and flat-racks in the theater. The movement control battalion provides essential information on container location, use, flow, and condition. They assist with control of containers by identifying that they are ready for return to the distribution system. The distribution management center sets priorities for container shipment and diversion.

(3) *Supply.* Supply provides the materiel required to accomplish the mission and is essential for enhancing Soldiers' quality of life. Supply includes the following classes:  
Class I—Subsistence, including ice, water and health and welfare items.

(a) Class II—Clothing, individual equipment, tentage, tool sets and tool kits, hand tools, administrative, and housekeeping supplies and equipment (including maps). This includes items of equipment, other than major items, prescribed in authorization / allowance tables and items of supply (not including repair parts).

(b) Class III—Petroleum, Oils, Lubricants (POL). Petroleum and solid fuels, including bulk and packaged fuels, lubricating oils and lubricants, petroleum specialty products; solid fuels, coal, and related products.

(c) Class IV—Construction Materiels, to include installed equipment and all fortification/barrier materiels.

(d) Class V—Ammunition of all types (e.g., small arms, bombs, explosives, tank and artillery rounds,



mines, fuses, detonators, pyrotechnics, missiles, rockets, propellants, and other associated items.

(e) Class VI—Personal Demand items (e.g., nonmilitary sales items).

(f) Class VII—Major End items. A final combination of end products which is ready for its intended use: (principal item) for example, launchers, tanks, mobile machine shops, vehicles.

(g) Class VIII—Medical Materiel, including uniquely medical repair parts.

(h) Class IX—Repair Parts and components, including kits, assemblies and subassemblies, reparable and nonreparable, required for maintenance support of all equipment.

(i) Class X—Materiel to support nonmilitary programs such as, agricultural and economic development, not included in Class I through Class IX.

(4) *Field Services*. Field services maintain unit combat strength by providing for basic needs and promoting health, welfare, morale, and endurance. Field services provide life support functions.

(a) *Shower and Laundry*. Shower and laundry capabilities provide Soldiers a minimum of two weekly showers and up to 17 pounds of laundered clothing each week (comprising three uniform sets, undergarments, socks, two towels, and two washcloths). The shower and laundry function does not include laundry decontamination support.

(b) *Field Feeding*. Food preparation is a basic unit function and one of the most important factors in Soldiers' health, morale, and welfare. The standard is to provide Soldiers at all echelons three quality meals per day (AR 30-22). Proper refuse and waste disposal is important to avoid unit signature trails and maintain field sanitation standards.

(c) *Water Production and Distribution*. Water production and distribution are essential for hydration, sanitation, food preparation, medical treatment, hygiene, construction, and decontamination. The Water production is both a field service and a supply function. Quartermaster supply units normally perform purification in conjunction with storage and distribution of potable water. Army is the Executive Agent for Tactical Land Based Water Resource Management.

(d) *Aerial Delivery*. Aerial delivery includes parachute packing, air item maintenance, and rigging of supplies and equipment. This function supports airborne insertions, airdrop and air land resupply. It is a vital link in the distribution system and provides the capability to supply forces when land LOCs have been disrupted or terrain is too hostile, thus adding flexibility to the distribution system.

(f) *Mortuary Affairs*. The Army maintains a mortuary affairs force structure capable of providing general backup support to the other Military Services when requested. Additionally, maintains theater-level mortuary affairs missions to include: (1) Operating mortuary affairs collection points; (2) Theater mortuary evacuation points; (3) Theater personal effects depots; (4) Mortuary affairs contaminated remains mitigation sites. Operates, maintains, and funds the Mortuary Affairs Reporting and Tracking System (MARTS) and administers the MARTS Configuration Control Board, which governs change within this system. As the DOD Executive Agent for the Chemical and Biological Defense Program, the Army researches, analyzes, and develops mortuary affairs products and guidelines pertaining to effective management of biological, chemical, and radiological contaminated human remains. (DODD 1300.22, Mortuary Affairs Policy (JP 4-06, Mortuary Affairs).

(5) *Distribution*. Distribution is the primary means to prolong endurance. Distribution is the operational process of synchronizing all elements of the logistics system to deliver the "right things" to the "right place" at the "right time" to support the Geographic Combatant Commander (GCC). Distribution is more than just transportation; it is the integration of supply stockage, transportation resources, and materiel management. Additionally, it is also the process of assigning military personnel to activities, units, or billets (JP 4-0). The distribution system consists of a complex of facilities, installations, methods, and procedures designed to receive, store, maintain, distribute, manage, and control the flow of military materiel between point of receipt into the military system and point of issue to using activities and units.

(a) *Global Distribution*. The Joint segment of the distribution system is referred to as global distribution. It is defined as the process that synchronizes and integrates the fulfillment of joint requirements with the employment of joint forces (JP 4-09). It provides national resources (personnel and materiel) to support the execution of joint operations.

(b) *Theater Distribution*. The Army segment of the distribution system is referred to as theater distribution. Theater distribution is the flow of equipment, personnel, and materiel within theater to meet the CCDR's mission. The Theater segment extends from the ports of debarkation or source of supply (in theater) to the points of need (units and Soldiers). It is enabled by a distribution management

system that synchronizes and coordinates facets of multiple networks (physical, communications, information, and resources) with operational and tactical sustainment functions to provide responsive support to operational requirements. Distribution management includes the management of transportation and movement control, warehousing, inventory control, order administration, site and location analysis, packaging, data processing, accountability for equipment (materiel management), people, and communications. See ATP 4-0.1, Army Theater Distribution for details. The distribution management of medical materiel is accomplished by a support team from the Medical Logistics Management Center (MLMC). The MLMC support team collocates with the Distribution Management Center (DMC) of the TSC/Expeditionary Sustainment Command (ESC) to provide the Medical Command (MEDCOM) Direct Support (DS) with visibility and control of all Class VIII.

(c) In-Transit Visibility (ITV) Total Asset Visibility (TAV). In-transit visibility is the ability to track the identity, status, and location of DOD units, non-unit cargo on the move (excluding bulk petroleum, oils, and lubricants) passengers, patients and personal property from origin to consignee, or destination across the range of military operations (JP 3-35). This includes force tracking and visibility of convoys, containers/pallets, transportation assets, other cargo, and distribution resources within the activities of a distribution node. (ITV/TAV) provides the distribution manager the ability to assess how well the distribution process is responding to supported force needs. Distribution managers gain and maintain visibility (items, personnel, units, transition hubs, and transport modes) at the earliest practical point in the management process. This allows managers to operate with timely information to effectively assess the status of resources, adapt and rapidly respond to immediate distribution requirements.

(d) Retrograde of Materiel. Another aspect of distribution is retrograde of materiel. Retrograde of materiel is the return of materiel from the owning/using unit back through the distribution system to the source of supply, directed ship-to location, and/or point of disposal (ATP 4-0.1). Retrograde includes turn-in/classification, preparation, packing, transporting, and shipping. To ensure these functions are properly executed, commanders must enforce supply accountability and discipline and use the proper packing materials. Retrograde of materiel can take place as part of theater distribution operations redeployment operations. Retrograde of materiel must be continuous and not be allowed to build up at supply points/nodes. The return of unserviceable repair parts for depot level repair is essential to providing future supply support to Army units. Early retrograde planning is essential and necessary to preclude the loss of materiel assets, minimize environmental impact, and maximize use of transportation capabilities. Planners must consider environmental issues when retrograding hazardous material. Contractor or HNS may be used in the retrograde of materiel. This support is planned for and negotiated early in the operation. HNS must be identified early enough to ensure personnel are properly screened and present no security risk. Leaders at all levels are responsible for the adherence to all policies and safety measures by contractors and HNS. Retrograde materiel flows through the distribution system from the tactical to strategic levels. Retrograde materiel is consolidated at the lowest supply support activity and reported up through the support operations for distribution instructions. When released by the maneuver commander, AMC assumes responsibility for providing disposition instructions, accounting, and shipping of retrograde materiel from the theater. An approved military customs inspection program must be in place prior to redeployment to preclear not only redeployment materiel but also the shipment of battle damaged equipment out of the theater. The Theater Army is responsible for establishing the customs inspection program to perform U.S. customs preclearance and United States Department of Agriculture (USDA) inspection and wash down on all materiel retrograded to the United States in accordance with Defense Transportation Regulation (DTR) 4500.9-R.

(6) *Operational Contract Support*. Operational contract support (OCS) is the integration of commercial sector support into military operations (JP 4-10, ATP 4-10, AR 715-9). While contracting officers play a key and legally binding role, OCS is commander's business with equities across all primary and certain special staff functions.

(a) The desired end-state of properly planned and integrated OCS actions include: enhanced command operational flexibility and sustainability through alternative sources of support; increased effectiveness, efficiencies, and cost avoidance of the contracting effort; increased visibility and ability to properly integrate contractor personnel and their equipment into military operations; ability of the commander to properly plan, integrate, and control the civil military impacts, both good and bad, of operational contract support actions; and decreased and/or mitigated contract fraud.

(b) Types of contracted support. There are three types of contracted support: theater support; external support; and system support. Theater support contracts are a type of contingency contract awarded by

contracting officers deployed to the operational area serving under the command and contracting authority of the contracting support brigade in support of that particular operation. These contracts, sometimes executed under expedited contracting authority (reduced time frames for posting of contract solicitations; allowing for simplified acquisition procedures for higher dollar contracts, etc.), provide goods, services, and minor construction mostly from locally available commercial sources. Also important from a contractor management perspective are local national employees that often make up the bulk of the theater support contractor workforce. External support contracts are awarded by contracting organizations outside of the AO. External support contracts provide a variety of logistics and other noncombat related services and supply support. External support contracts normally include a mix of U.S. citizens, host nation, and local national contractor employees. Examples of external support contracts are: service (Air Force, Army, and Navy) civil augmentation programs; special skills contract (staff augmentation, linguists, etc.); DLA prime vendor contracts; and the largest and most commonly known Army external support contract is the Army's Logistics Civil Augmentation Program (LOGCAP). LOGCAP can provide a complete range of logistics services, including supply services (e.g., storage, warehousing, distribution, etc.) for the nine classes of supplies, but does not include the actual provisioning of these commodities. System support contracts are prearranged contracts associated with acquisition program executive officers (PEOs) and project/product management (PM) officers. These centrally funded contracts provide technical, maintenance and, in some cases, Class IX support for a variety of Army weapon and support systems. System support contracts are routinely put in place to provide support to newly fielded weapon systems, including aircraft, land combat vehicles, and automated command and control information systems. System support contractor employees, made up mostly of U.S. citizens, provide support both in garrison and in deployed operations. Operational commanders generally have less influence on the execution of system support contracts than other types of contracted support.

(c) Individual training. There are three primary operational contract support courses available from the joint staff and the Army Logistic University (ALU). Contracting Officer Representative (COR) training is a 40 hour ALU course certified Soldiers and civilians to be level B CORs. This course is offered as both a resident class at Fort Lee and via mobile training teams to various Army installations world-wide. Operational Contract Support Course is a two week course that awards the 3C additional skill identifier and is designed to prepare military and government civilians to function in assignments that involve tactical level operational contract support planning and integration functions. Students learn the latest OCS doctrine; how to integrate contract support requirements into the military decision making process; how to build acquisition ready requirements (known as requirements review board packets) to include performance work statement development and independent government estimates; how to integrate contract requirements into the overall unit spend plan process; how to set up and build contract management files; how to build quality assurance surveillance plans and manage CORs; and how to avoid common pitfalls customarily associated with outsourcing requirements. The graduate of the OCS course will provide the unit commander and staffs with the expertise necessary to properly and proactively manage contracts and contract requirements. Like the COR course, this course is offered as both a resident class at Fort Lee and via mobile training teams to various Army installations world-wide. Joint Operational Contract Support Planning and Execution Course (JOPEC) is a two week long joint course is similar to the ALU course except it focuses at the theater strategic and operational levels. This Joint Staff J-4 controlled course is available to Army officers serving on theater army, field army, corps, divisions and theater level support headquarters staff. JOPEC is offered via mobile training teams to various locations worldwide.

(d) Organizations. Army Contracting Command at Rock Island Arsenal, IL is the main element within the Army to provide Operational Contracting support. Contracting Support Brigades are subordinate units to ACC and are located in each of the ASCC AORs. These Brigades provide the contracting support to the ASCC commander and requiring activities. These brigades have Contracting Battalions and Senior Contingency Contracting Teams that can be dispersed in the AOR as needed. A newly developed Contingency Contracting Team is allocated to each BCT for contracting needs of the units.

(e) Requiring Activity Responsibilities. It must be remembered that ACC and subordinate units do the contracting work to provide the goods or services to the requiring activity. The Requiring activity is responsible for managing the work of the contractor in accordance with the Quality Assurance Surveillance Plan and Performance Work Statement; developing the Statement of Work (what is required in detail for the contractor to perform) and providing the COR; designating funds for operations of the contract to include contract closeout; and providing and recovering any government furnished property

needed by the contractor.

(7) *General Engineering Support.* The Army has a broad range of diverse engineer capabilities, which commanders can use to accomplish various tasks for various purposes. One such purpose is to provide support to ground force commanders that enables logistics. To accomplish this purpose, engineers combine and apply capabilities from all three engineer disciplines (combat, general, and geospatial engineering) to establish and maintain the infrastructure necessary for sustaining military operations in the AO. This involves primarily general engineering tasks that consist largely of building, repairing, and maintaining roads, bridges, airfields, and other structures and facilities needed for Aerial Port of Debarkations (APODS), Sea Port of Debarkations (SPODS), main supply routes, and base camps. Depending on the range of military operations, other tasks include the planning, acquisition, management, remediation and disposition of real estate, supplying mobile electric power, utilities and waste management, environmental support and firefighting. Although engineering tasks that enable logistics are primarily considered general engineering tasks, engineers also use capabilities from the other engineer disciplines for the same purpose. Similarly, although general engineering tasks are often used to enable logistics, engineers also use capabilities from the general engineering discipline for other purposes and to support other warfighting functions. FM 3-34 provides additional information about all three engineer disciplines and how they are used for various purposes and to support all the warfighting functions.

## Section II

### National Logistics Organization—Assistant Secretary of the Army (Acquisition, Logistics, and Technology), Army G-4, Army G-8, Army Materiel Command, and Logistics Innovation Agency

#### 11-3. Assistant Secretary of the Army for Acquisition, Logistics, and Technology

The ASA(ALT) is the principal adviser to the Secretary of the Army (SECARMY) on all matters relating to acquisition, logistics and technology. The ASA(ALT) is responsible for the overall supervision of the acquisition, logistics and technology matters of DA and has sole responsibility for performing the acquisition function within HQDA. The ASA(ALT) is designated as the Army Acquisition Executive (AAE), Senior Procurement Executive and Senior Official responsible for the management of acquisition of contract services, Science Adviser to the SECARMY and senior research and development official for DA. The ASA(ALT) is responsible for setting the strategic direction for and ensuring that DA policies, plans and programs related to acquisition, logistics, technology, procurement, the industrial base, materiel related security cooperation (including security assistance and armaments cooperation), and the Army's portion of the Chemical Demilitarization Program are executed consistent with law, regulation and policy. The Office of the ASA(ALT) is designated the single office for the acquisition function in HQDA and, subject to the authority, direction and control of the SECARMY, provides the CSA such staff support for acquisition matters as the CSA considers necessary to perform his duties and responsibilities. The ASA(ALT) is assigned responsibility for—

- a. Establishing strategic direction for aspects of the Planning, Programming, Budgeting, and Execution (PPBE) process within the ASA(ALT)'s assigned functions and responsibilities, including acquisition, logistics, technology, procurement and associated resource allocation decisions and policies and, when appropriate, coordinating and integrating that direction with the ASA Financial Management and Comptroller (FM&C); Chief Information Officer (CIO); DCS, G-4; DCS, G-3/5/7; DCS, G-8; and other DA officials and organizations.
- b. Providing strategic guidance and supervision for policies and programs for any procurement, logistics and technology initiatives executed by DA officials, organizations and commands.
- c. Exercising sole authority for providing materiel solutions to equipment modernization requirements.
- d. Developing and executing the Army's acquisition function and the acquisition management system, including Army acquisition programs and Army acquisition policy, and chairing the Army Systems Acquisition Review Council (ASARC) and Configuration Steering Board.
- e. Supervising the research and development function for DA and directing the Army Science Board (ASB).
- f. Executing, as the AAE and consistent with DA requirements for appointing executive or senior professionals, the functions and duties of the SECARMY with respect to the acquisition workforce, including managing the Army Acquisition Corps and Army Acquisition Workforce; appointing those personnel below the executive level; and managing and evaluating acquisition program executive officers

and direct-reporting program, project and product managers.

- g. Executing the authorities of the agency head for contracting procurement matters pursuant to laws and regulations.
- h. Supervising logistics, including acquisition fielding, sustainment and disposal logistics management, and administering life cycle logistics support planning and execution.
- i. Supervising the development, coordination and implementation of policy and programs for the Army's materiel related security cooperation activities, to include foreign military sales (FMS), foreign military training (FMT), allocation of excess defense articles (EDA) to foreign countries, armaments cooperation, technology transfer, direct commercial sales, and munitions case processing.
- j. Providing export policy supervision and chairing and directing the Technology Transfer Security Assistance Review Panel.
- k. Supervising the Director, U.S. Army Chemical Materials Agency and the activities of the Army portion of the Chemical Demilitarization Program, including chemical stockpile emergency preparedness efforts.
- l. Representing the Army in relevant matters to DOD and non-DOD partners.
- m. Co-chair of the SS (Sustaining) Program Evaluation Group (PEG) (see Chap 8, PPBE).

#### 11-4. Deputy Chief of Staff, G-4

The DCS, G-4 is the principal military adviser to the ASA(ALT) for logistics. The DCS, G-4 is the principal ARSTAF adviser to the CSA on logistics and assists the CSA in acting as the agent of the SECARMY in executing approved plans and recommendations. Under the supervision of ASA(ALT), for Army logistics and sustainment issues, the DCS, G-4 develops and executes Army strategy, policy, plans and programs for logistics and sustainment; ensures the execution of policies, plans and programs consistent with law, regulation and policy by other DA officials and organizations; and reviews and assesses the execution of Army logistics policies, plans and programs. The DCS, G-4 is assigned responsibility for:

- a. Collaborating on logistics operations in support of security cooperation and representing the Army on coalition sustainment standardization actions.
- b. Maintaining current logistics operations, contingency plans and resource programs that support Army-wide logistics operations.
- c. Executing staff prepotency for the logistics civil augmentation program and coordinating the development of multinational force interoperability policy and practice for the use of allied civil augmentation programs.
- d. Serving as proponent for Army equipment safety and Army airworthiness.
- e. Advising on and monitoring the Army's Property Accountability program, and the materiel readiness to determine Army-wide readiness trends.
- f. Ensuring that supportability requirements are incorporated into acquisition and fielding requirements for new systems.
- g. Assisting in the supervision of the execution of Army logistics policies, programs, budgetary inputs and activities.
- h. Coordinating with and supporting the ASA Installations Energy and Environment (IE&E) on issues, policies and programs related to energy security, including operational and tactical energy, and contingency bases.
- i. Supporting the ASA(ALT) in the Army's organic industrial base matters and activities.
- j. Ensuring sustainment functions and related logistics automated information systems management are fully integrated and properly balanced between acquisition and sustainment.
- k. Co-chair of the SS (Sustaining) PEG (see Chap 8, PPBE).

#### 11-5. Deputy Chief of Staff, G-8

The DCS, G-8 is the principal military adviser to the ASA(FM&C) for program development and justification. In performing this function, the DCS, G-8 coordinates with the ASA(ALT) on all proposed programming recommendations that are related to ongoing acquisition program and science and technology initiatives. The DCS, G-8 is the principal ARSTAF adviser to the CSA on all materiel requirements, integration and programming of Army and joint materiel capabilities. The DCS, G-8 is assigned responsibility for:

- a. Supervising the Director, Program Analysis and Evaluation, who is—
  - (1) Responsible for developing and defending the Army Program under the guidance and direction of the ASA(FM&C) and the DCS, G-8. This includes managing the programming phase of PPBE to facilitate the

development and defense of the Army Program and the Future Years Defense Program, developing and maintaining the Army's authoritative resource position database and ensuring the coordination of the programming and budgeting phases of PPBE and an effective transition to an Army budget estimate.

(2) Directly responsible to the SECARMY and CSA, including for developing and providing an independent assessment of the Army Program.

a. Managing the Center for Army Analysis (CAA) and other HQDA studies and providing analytic support to HQDA.

b. Developing plans, in coordination with the ASA(ALT), for equipping the future Army through programming, materiel integration and studies.

c. Coordinating Army input and participation in joint requirements matters considered by DOD bodies and supporting the CSA and VCSA in their related responsibilities.

d. Co-chair of the EE (Equipping) PEG (see Chap 8, PPBE).

## 11-6. Army Materiel Command

AMC is the Army's principal provider of materiel and its readiness – technology, acquisition support, materiel development, logistics power projection, and sustainment – to the total force, across the spectrum of joint military operations. If a Soldier shoots it, drives it, flies it, or communicates with it, AMC provides it. AMC is the Army's Lead Materiel Integrator (LMI) with the mission to synchronize the distribution and redistribution of Class VII principal items in accordance with Army priorities and directives. AMC is headquartered at Redstone Arsenal, Alabama, and impacts or has a presence in all 50 states and 150 countries. Manning these organizations is a work force of more than 60,000 dedicated military and civilian employees, many with highly developed specialties in weapons development, manufacturing, and logistics. To develop, buy, and maintain materiel for the Army, AMC works closely with PEOs, the AAE, industry, academia, and other related agencies. The command's complex missions range from development of sophisticated weapons systems and cutting-edge research, to maintenance and distribution of spare parts. The command's maintenance depots and arsenals overhaul, modernize, and upgrade major weapons systems – not just making them like new, but inserting technology to make them better and more reliable. AMC operates the research, development and engineering centers; Army Research Laboratory; depots; arsenals; munition plants; and other facilities; and maintains the Army's Prepositioned Stocks (APS), both on land and afloat. The command is the DOD Executive Agent for the chemical weapons stockpile. AMC includes global surface transportation experts who provide the Warfighter with a single surface distribution provider for adaptive solutions that deliver capability and sustainment on time. AMC also handles the majority of the Army's contracting including a full range of contracting services for deployed units and installation-level services, supplies, and common-use information technology hardware and software. It operates a network of Army field support brigades and battalions, logistics support elements, and brigade logistics support teams, all of which identify and resolve equipment and maintenance problems, and materiel readiness issues for combatant commands. AMC handles diverse missions that reach far beyond the Army. For example, AMC manages the multibillion-dollar business of selling Army equipment and services to friends and allies of the United States and negotiates and implements agreements for co-production of U.S. weapons systems by foreign nations. AMC provides numerous acquisition and logistics services to the other components of the DOD and many other government agencies. The AMC subordinate commands are—

a. U.S. Army Chemical Materials Activity (CMA). CMA is responsible for the safe and effective storage, treatment, and disposal of U.S. chemical weapons safely and effectively. The activity develops and uses technologies to safely store and eliminate chemical weapons at seven stockpile sites while protecting the public, its workers and the environment. CMA also has the storage mission at the Nation's final two stockpile sites.

b. U.S. Army Security Assistance Command (USASAC).

(1) USASAC is responsible for managing security assistance programs and Foreign Military Sales (FMS) for the Army. USASAC serves as the primary entry point for U.S. Army materiel-and service related FMS requirements. Its mission is leading the AMC Security Assistance Enterprise, developing and managing security assistance programs and FMS cases to build partner capacity, supporting Combatant Command (CCMD) engagement strategies, and strengthening U.S. global partnerships. USASAC is responsible for Army security assistance information management and financial policy; provides policy, procedure, and guidance to the Army security assistance community; and manages the Army's co-production program. The U.S. Army Security Assistance Training Management Organization

(USASATMO) is a subordinate command of USASAC that can deploy teams throughout the world to provide training tailored to a country for equipment purchased through FMS. Locations: Headquarters, Redstone Arsenal, Alabama; New Cumberland, Pennsylvania; Washington Field Office, Fort Belvoir, Virginia; U.S. Army Security Assistance Training Management Organization, Fort Bragg, North Carolina; Office of the Program Manager, Saudi Arabian National Guard Modernization Program (SANG), Riyadh, Saudi Arabia; Liaison Officers at each Combatant Commands (CCMD), Kuwait and Afghanistan.

(2) Security assistance is a national program supervised and directed by the State Department. In conjunction with the White House, Congress, and the Treasury Department, military security assistance programs are executed by the DOD. The FMS program (see Fig 11-1) is the U.S. government's program for transferring defense articles, services and training to other sovereign nations and international organizations. Under FMS, the U.S. government procures defense articles on behalf of the foreign customer. The President of the United States designates countries and international organizations eligible to participate in FMS. The Department of State makes those recommendations and approves individual programs on a case-by-case basis. Countries approved to participate in this program may obtain defense articles and services by paying with their own national funds or with funds provided through U.S. government-sponsored assistance programs. In certain cases, defense articles, services and training may be obtained on a grant basis. The Defense Security Cooperation Agency (DSCA) administers the FMS program for DOD. USASAC implements approved U.S. Army security assistance programs, including FMS of defense articles and services to eligible foreign governments. In carrying out the Army security assistance mission, USASAC calls on all AMC Life Cycle Management Commands (LCMC), as well as other DOD agencies and U.S. industry. Each sale of equipment to overseas customers comprises the same "total package" of quality materiel, facilities, spare parts, training, publications, technical documentation, maintenance support, and other services that AMC provides to U.S. Army units. USASAC is responsible for life cycle management of FMS cases, from preletter of request, development, execution, and closure.

c. Aviation and Missile Command (AMCOM) LCMC. Aviation and Missile LCMC, unites all of the organizations that work to design, acquire, integrate, field, and sustain Army aviation, missile, and unmanned aircraft weapon systems. Headquartered at Redstone Arsenal, AL, the Aviation and Missile Materiel Enterprise is comprised of the Aviation and Missile Research, Development and Engineering Center (AMRDEC), the Army Contracting Command-Redstone, the Program Executive Officer (PEO) Aviation, and the PEO Missiles and Space. AMCOM also supports PEO Aviation and the PEO Missiles and Space as they execute their missions of acquiring and managing the Army's aviation and missile systems. AMCOM performs several steps in the life cycle of Army aviation and missile systems, including procurement, maintenance and repair of spare parts, flight safety, maintenance and overhaul, Foreign Military Sales, and, eventually, retirement or demilitarization. AMCOM provides depot level support to the Army's aviation and missile systems at Corpus Christi Army Depot (CCAD) and Letterkenny Army Depot (LEAD). Depot support comprises specialized, complex maintenance and overhaul activities. Resetting equipment, along with repairing crash and battle-damaged aircraft, are two key missions performed at AMCOM's depots.

d. Communications-Electronics Command (CECOM) LCMC. CECOM is responsible for life cycle support of communications-electronics systems and equipment. CECOM's mission is to develop, acquire, provide, and sustain world-class Command, Control, Computers, Intelligence, Surveillance and Reconnaissance (C4ISR) systems and battle command capabilities for the joint Warfighter. As an LCMC, CECOM conducts training missions; provides field support for equipment and systems modifications and upgrades; and provides logistical expertise to ensure the on-time delivery of equipment, services, and capabilities to the Warfighter. CECOM also plays an integral part in the establishment and optimization of the Army's C4ISR Materiel Enterprise and C4ISR Center of Excellence (CoE), also located at Aberdeen Proving Ground (APG), MD. The C4ISR Materiel Enterprise is co-chaired by AMC and the ASA(ALT). Together, these organizations develop, acquire, provide, field, and sustain world-class C4ISR systems and battle command capabilities for the joint Warfighter. CECOM is comprised of approximately 8,500 military, civilian, and contract personnel. CECOM provides depot level support at Tobyhanna Army Depot (TYAD), Tobyhanna, PA. TYAD is the Army's premier depot providing maintenance, manufacturing, integration, and fielded repair to C4ISR systems worldwide, including more than 80 forward repair activities. TYAD accomplishes maintenance, fabrication, and system integration for Army, Navy, and Air Force C4ISR systems.



**Figure 11-1. Foreign Military Sales Process**

e. Joint Munitions & Lethality LCMC. JM&L LCMC manages research, development, production, storage, distribution, and demilitarization of all conventional ammunition and the personnel, organizations, infrastructure, and processes required for effective life cycle management of conventional ammunition within the DOD. JM&L LCMC is headquartered at Picatinny Arsenal, NJ, with major components located at Rock Island Arsenal (RIA), IL, and at Picatinny. While the objectives of the JM&L LCMC are to facilitate product responsiveness, minimize life cycle costs, and enhance the effectiveness and integration of munitions and lethality acquisition, logistics, and technology, its overarching objective is to deliver the best munitions to the right place, at the right time, and at the right cost. The JM&L LCMC brings together the resources and expertise of its three component organizations: the Program Executive Office for Ammunition located at Picatinny Arsenal, Joint Munitions Command (JMC) at Rock Island, and the Armament Research, Development and Engineering Center (ARDEC), also at Picatinny. It also oversees a nationwide network of installations and facilities that produce and store conventional ammunition under the direction of JMC. JMC manages the Army's ammunition plants and depots and serves as the logistics arm of the LCMC. JMC installations produce, store, issue, and demilitarize conventional ammunition for all U.S. military services, and for other U.S. agencies and allied nations as directed. JMC manages the Army's 14 ammunition production plants and storage depots. JMC also serves as the logistics and readiness arm of the LCMC, ensuring that munitions are delivered at the right place and time to support unit training and deployments.

f. Tank and Automotive Command (TACOM) LCMC. The TACOM LCMC, headquartered in Warren, MI, unites all of the organizations that focus on Soldier and ground systems throughout the entire life cycle. The TACOM LCMC mission is to develop, acquire, field, and sustain Soldier and ground systems or America's warfighters. The TACOM LCMC consists of the Integrated Logistics Support Center, Program Executive Office (PEO)-Combat Support and Combat Service Support, PEO-Ground Combat Systems,



and PEO-Soldier. The TACOM LCMC is also aligned with several business partners: U.S. Army Tank Automotive Research, Development and Engineering Center; Army Contracting Command - Warren; U.S. Army Armaments Research, Development and Engineering Center; Natick Soldier Research, Development and Engineering Center; Edgewood Chemical and Biological Center; Joint Program Executive Office for Chemical and Biological Defense; and System of Systems Integration Directorate. Successful execution of TACOM LCMC's mission requires effective communication and coordination among the acquisition, logistics, and technology (ALT) organizations that are part of the TACOM LCMC and the Army's Materiel Enterprise. TACOM's arsenal and depots are: Watervliet Arsenal (WVA), Watervliet, NY; Anniston Army Depot (ANAD), Anniston, AL; Red River Army Depot (RRAD), Texarkana, TX; and Sierra Army Depot, Herlong, CA.

g. U.S. Army Research, Development, and Engineering Command (RDECOM). RDECOM is headquartered at Aberdeen Proving Ground, Maryland. RDECOM's mission is to empower, unburden and protect joint forces to enable the dominance of the Army. RDECOM is the Army's largest technology developer and it provides the Army a critical system engineering capabilities. The command has more than 17,600 scientists, engineers and other professionals. RDECOM works to create balance between developing technology solutions for the current fight and investing in future capabilities for tomorrow's challenges. The command uses its expansive working relationships with university-level institutions, its small business innovative research agreements and its cooperative research and development agreements with industry as well as international agreements with more than two dozen countries to improve the capabilities of the Army's research, development and engineering processes.

h. Military Surface Deployment and Distribution Command (SDDC). SDDC is headquartered at Scott AFB, IL. SDDC's mission is to provide expeditionary and sustained end-to-end deployment and distribution to meet the Nation's objectives. SDDC is the ASCC of the U.S. Transportation Command (USTRANSCOM). This relationship links USTRANSCOM's Joint Deployment and Distribution Enterprise and AMC's Materiel Enterprise. The command also partners with the commercial transportation industry as the coordinating link between DOD surface transportation requirements and the capability industry provides. SDDC's success in deploying and redeploying the Defense Department's personnel and assets is achieved by coordination and leveraging the capability of the commercial transportation industry and other military assets to create an efficient flow of materiel worldwide. SDDC averages about 20 million square feet of deployment and redeployment cargo movements each year or roughly 314 vessel operations per year. SDDC operates 24 ports spread throughout the continental U.S. and the world. Their support teams are able to deploy to virtually any port in the world. SDDC manages and coordinates all surface moves in support of door-to-door container and break bulk cargo movements around the globe and provides domestic routing services for rail and highway movements in the continental U.S., including arms, ammunition and explosives. SDDC also manages the assets of the Defense Rail Interchange Fleet and the Army's Containerized Ammunition Distribution System. In addition, SDDC manages household goods, privately owned vehicles and bus charters for Soldiers.

i. U.S. Army Contracting Command (ACC). ACC's Soldiers, civilians, and contractors support Soldiers worldwide by acquiring equipment, supplies, and services vital to Soldiers' mission and well-being. ACC ensures contracting support as mission requirements emerge and as the Army transforms and moves within the continental United States and throughout the globe. Headquartered at Redstone Arsenal, AL, ACC has two subordinate commands – the Expeditionary Contracting Command (ECC) (for locations outside the continental United States) and the Mission and Installation Contracting Command (MICC) – and six major contracting centers that provide support to AMC's life cycle management commands and MSCs. These centers also provide contracting support to several program executive offices and program managers supporting the U.S. Army's major acquisition programs. The ECC provides effective and agile contracting service across the full spectrum of military operations for U.S. Army Service Component Commanders in support of Army and joint operations as well as to other defense organizations at locations outside the continental United States. ECC accomplishes this vital mission through seven contracting support brigades, eight contingency contracting battalions, and 83 contingency contracting teams throughout the world. The MICC provides contracting support across Army commands, installations, and activities located throughout the continental United States, Alaska, and Puerto Rico. Its customers include the U.S. Army Installation Management Command, U.S. Army Forces Command, U.S. Army Training and Doctrine Command (TRADOC), U.S. Army North, U.S. Army Reserve Command, and U.S. Army Medical Command.

j. U.S. Army Sustainment Command (ASC). The ASC organizes, trains, and sustains a quality

deployable force and integrates materiel and services to the Soldier. Rock Island Arsenal, ASC, provides support through the Lead Materiel Integrator (LMI) program, Materiel Management, the LOGCAP Program Management Office, APS, and the Directorates of Logistics. Major ASC responsibilities include:

(1) Lead Materiel Integrator (LMI). The AMC effectively and efficiently distributes and redistributes materiel to support the generation of trained and ready forces. As AMC's executing agent for LMI, ASC is the single integrator to ensure Soldiers have the right equipment at the right time to accomplish their missions. Materiel Management: ASC provides materiel readiness visibility and management, including property accountability and source of repair work loading. The Distribution Management Center works contracting requirements, supply management, Army Force Generation equipping strategy, and Directorate of Logistics realignment.

(2) LOGCAP Program Management. The purpose of the Logistics Civil Augmentation Program (LOGCAP) is to augment deployed Army forces and other designated organizations with sustainment support services as required by mission specific factors. LOGCAP is a Department of the Army (DA) regulatory program (AR 700-137) that includes pre-planned, logistics and general engineering/ minor construction support augmentation executed through pre-awarded contracts to selected LOGCAP performance contractor companies. LOGCAP's unique power is related to the operational commander's ability to leverage the designated performance contractor's existing global and regional commercial resources through these pre-selected performance contractors to sustain operations in any environment and during any operational phase. LOGCAP is designed to support preplanned sustainment support during peacetime and execution of that support through contract task orders for deployed forces performing combatant command directed missions. LOGCAP is an immensely capable program that leverages commercial capabilities to provide augmentation for most Army sustainment functions (per ADRP 4-0) in support of Army missions. LOGCAP can also be utilized to provide support for some common support functions not currently found in existing Army force structure. LOGCAP has been designated a strategic source for Logistics Management Services by the Assistant Secretary of the Army for Acquisition, Logistics, and Technology (ASAALT). By design, the program reduces the need for the requiring activity and supporting contracting activities to develop individual contract solutions. Use of LOGCAP vice other contract solutions can reduce the requiring activities and supporting contracting activity burden very significantly by leveraging the LOGCAP Program Management Office, part of ASC at Rock Island, IL, and its deployable support elements, especially in large scale operations. Individual sustainment requirement sets are integrated across the LOGCAP footprint to achieve economy of scale and other efficiencies without compromising effectiveness, based on established in law, policy and doctrine. While best known for operations in support of U.S. Forces during Operation Enduring Freedom (OEF) / Operation Iraqi Freedom (OIF), LOGCAP, when authorized by HQDA, is capable of supporting all Service components, allies, coalition forces, and even other governmental agencies across the range of military operations.

(3) Army Prepositioned Stocks (APS). ASC maintains, accounts for, cares for stocks in storage worldwide and issues stocks to deploying units worldwide. These stocks include combat equipment and supplies (CL I, IV, III(P), V, VIII and IX), and humanitarian mission stocks, at land- and sea-based positions strategically located in the continental United States, Italy, Korea, Germany, Japan, Kuwait, Qatar, Afghanistan and ships at sea. There are currently 5 APS sets with a sixth being staffed for approval by FY17: APS-1 located in CONUS that maintains the supplies for Days 61-180; APS-2 is located in Italy and Germany (the set mainly consists of the European Activity Set – a BDE set used both for training and available for warfighting contingencies); APS-3 is located afloat on container and LMSR leased vessels from Military Sealift command (maintenance and sustainment of the equipment is done at the Charleston Support Activity); APS-4 is located in Japan and Korea; APS-5 is located in Kuwait and Qatar; and APS-6 for SOUTHCOM (composition and location to be determined). APS maintains Operational projects in each APS location. These are special requirements above unit MTOE authorizations that are pre-staged in the AOR as needed. Examples of Operational Projects are supplies to build an Enemy Prisoner of War Camp, Bridging materiel, Hot and Cold Weather gear and other items specifically requested by the ASCC commander. Activity Sets are a new category of APS. These serve a dual purpose. These are owned and maintained by AMC but can be issued for training purposes. There is only one activity set as of this publication but several more are planned in SOUTHCOM and PACOM AORs.

(4) Directorates of Logistics (DOL). Transferring all functions and responsibilities of the DOLs around the globe from the Installation Management Command to AMC, with full operational control in fiscal year 2013 to ASC's Army Field Support Brigades, aligns logistics support with core competencies. The

objective is to provide as good or better service at the best value, by increasing quality, efficiency, and standardizing performance across the Materiel Enterprise. This transfer essentially places the Army's field-level maintenance and supply capabilities under the command and control of one single command structure, the ASC. To more effectively describe the efficiencies realized by aligning all DOL services under one command and contracting strategy, these installation logistics providers are now named Logistics Readiness Centers (LRC).

### 11-7. Logistics Innovation Agency

The U.S. Army Logistics Innovation Agency (LIA), headquartered at Fort Belvoir, VA, is the field operating agency (FOA) of the Headquarters, Department of the Army (HQDA), Deputy Chief of Staff (DCS), G-4 (Logistics). LIA's mission is to assess, develop, and integrate innovative logistics policy, process, and program solutions in support of HQDA DCS, G-4 decisions and priorities. LIA provides an Army Staff-level perspective of logistics-related technologies, policies, process enhancements, and business practices to identify and address capability gaps in Army logistics processes. LIA provides a variety of key functions and services in the modernization of logistics domain processes and practices unique to Army logistics. LIA's contributions to the Army include:

- a. Integrating the Logistics Business Mission Area (BMA) End-to-End (E2E) processes with the Acquisition, Financial Management, Human Resources Management, and Installation & Environment Domains, as well as aligning those E2Es with the Logistics Warfighting Mission Area to be able to identify gaps, determine requirements, and assess solutions.
- b. Providing the DCS, G-4 as the Domain lead, the Logistics BMA architecture necessary for investment management decisions, business process re-engineering efforts, and systems architecture development.
- c. Managing an implementation plan and assessment framework for Army logistics that incorporates cost information to assess risks, make resource-informed decisions, and develop innovative solutions to increase efficiency and effectiveness in meeting strategic readiness targets.
- d. Providing analytic capabilities to the DCS, G-4, to solve complex problems associated with G-4 Policy, Programming, and Strategic Planning decisions to include: the G-4's program objective memorandum (POM) development and assessment process, including traceability/validation of requirements, linking requirements to operational outcomes; providing Business Case Analyses in support of Defense Business System requirements validation and acquisition recommendations; improving sustainment costing and resourcing through more accurate and defensible weapon system life cycle cost estimates; and increasing Army Readiness.
- e. Leading the Army G-4 Logistics Domain Audit Readiness mission to ensure the Army is audit-ready and prepared for the Congressionally-mandated external audit by Fiscal Year (FY) 2018, as directed by the National Defense Authorization Act of 2010, and maintaining those standards beyond FY18.
- f. Facilitating and synchronizing development of innovative solutions to improve the efficiency and effectiveness of supply, maintenance, and distribution processes in support of the Army of the Future.

### 11-8. Theater Sustainment

- a. The Theater Sustainment Command (TSC) serves as the senior Army sustainment HQ (less medical) for the Theater Army. The TSC provides mission command of support units assigned, attached, or OPCON to the theater. The mission of the TSC is to provide mission command for operational level logistics within an assigned AOR (less medical) (FM 4-94). The TSC is capable of planning, preparing, executing, and assessing logistics and human resource support for Army forces in theater. It provides support to unified land operations. As the distribution coordinator in theater, the TSC leverages strategic partnerships and joint capabilities to establish an integrated theater-level distribution system that is responsive to Theater Army requirements. It employs sustainment brigades to execute theater opening (TO), theater sustainment, and theater distribution operations. The TSC includes units capable of providing multifunctional logistics: supply, maintenance, transportation, petroleum, port, and terminal operations. Other specialized capabilities, such as mortuary affairs (MA), aerial delivery, human resources, sustainment to internment/resettlement operations, and financial management, are available from the force pool. The combination of these capabilities gives the TSC commander the ability to organize and provide tailored support.
- b. The Expeditionary Sustainment Commands (ESC) are force pooled assets. They are normally under the mission command of the TSC. The ESC provides mission command of sustainment units (less medical) in designated areas of a theater. The ESC plans, prepares, executes, and assesses

sustainment, distribution, theater opening, and reception, staging, and onward movement operations for Army forces in theater. It may serve as a basis for an expeditionary command for joint logistics when directed by the Geographical Combat Commander (GCC) or designated multinational or joint task force commander. It normally deploys when the TSC determines that a forward command presence is required. This capability provides the TSC commander with the regional focus necessary to provide effective operational-level support to Army or JTF missions.

c. The Sustainment Brigade (SB), when deployed, is a subordinate command of the TSC, or by extension the ESC. The sustainment brigade is a flexible, multifunctional sustainment organization, tailored and task organized according to mission, enemy, terrain and weather, troops and support available, time available, and civil considerations (METT-TC). It plans, prepares, executes, and assesses sustainment operations within an area of operations. It provides mission command of sustainment operations and distribution management.

d. The Army Field Support Brigade (AFSB) is assigned to the ASC, and when deployed, is placed OPCON to the supported Theater Army. This OPCON relationship is normally delegated to the supporting TSC or ESC as appropriate. An AFSB provides materiel readiness focused support to include coordination of acquisition logistics and technology actions, less theater support contracting and medical, to Army operational forces. AFSBs serve as ASC's link between the generating force and the operational force. AFSBs are also responsible to integrate LOGCAP support into contract support integration plans, in coordination with the theater Army G-4 and the supporting CSB (ATP 4-91).

e. The Combat Sustainment Support Battalion (CSSB) is a flexible and responsive unit subordinate to the Sustainment Brigade that executes logistics throughout the depth of an area of operations including transportation, maintenance, ammunition, supply, MA, airdrop, field services, water, and petroleum. The CSSB is attached to a sustainment brigade and is the building block upon which the sustainment brigade capabilities are developed. The CSSB is tailored to meet specific mission requirements. Employed on an area basis, the CSSB plans, prepares, executes, and assesses logistics operations within an area of operations. The CSSB also supports units in or passing through its designated area. The CSSB may operate remotely from the sustainment brigade and therefore must maintain communications with the sustainment brigade. The CSSB establishes voice communications to support mission command and convoy operations as well as to monitor, update, and evaluate the logistics posture.

f. The Brigade Support Battalion (BSB) is an organic component of BCT, fires, and maneuver enhancement brigades. The BSB is tailored to support the particular brigade to which it is organic. For example, the BSB of an armor brigade combat team (HBCT) has more fuel distribution capabilities and maintenance than does a fires brigade BSB. The BSB provides supply, maintenance, motor transport, and medical support to the supported brigade. The BSB plans, prepares, and executes, logistics operations in support of brigade operations (ATP 4-90).

g. The Aviation Support Battalion (ASB) is the primary aviation logistics organization organic to a Combat Aviation Brigade and the Theater Aviation Brigade. The ASB performs the BSB mission. It provides aviation and ground field maintenance, brigade-wide satellite signal support, replenishment of all supplies, and medical support to the aviation brigade. The Aviation Support Battalion has been optimized to support the Combat Aviation Brigade's forward support companies, aviation maintenance companies, and the brigade HQ and HQ Company (FM 3-04.111).

h. The Medical Command (Deployment Support) conserves the fighting strength of the tactical commander through synchronization of Army Health Systems operations and providing mission command of AHS units assigned or attached to the headquarters providing health service support to tactical commanders while simultaneously conducting stability tasks. The MEDCOM (DS) serves as the medical force provider within the Area of Operations and focused on medical OPLANS and contingency plans. It maintains visibility and utilization of medical infrastructure, treatment and evacuation capabilities. It accomplishes Title 10 responsibilities and Army support to other Services for their AO. It also identifies and evaluates health care requirements throughout this AO.

i. The Human Resources Sustainment Center (HRSC) functions as a staff element of the TSC. The HRSC provides theater-level support to the ASCC G-1 and enables the TSC Commander to plan, integrate and execute HR support to the theater. The TSC is the key linkage between the ASCC G-1 who provides the policy, direction, and guidance for HR support to the theater and the HRSC, which executes the HR support mission for postal, casualty, reception, replacement, return to duty, redeployment, rest & recuperation and personnel accounting and strength reporting. The HRSC has a defined role to ensure that the theater HR support plan is developed and then supported with available resources within the TSC.

The HRSC is the technical link to HR organizations which execute postal, reception, replacement, redeployment, return to duty rest & recuperation, casualty operations, and personnel accountability support functions.

j. The Financial Management Center (FMC) functions as a staff element of the TSC and asserts technical coordination over all Army financial management companies and detachments in theater. The FMC Director, in coordination with the TSC G-8 or Support Operations, is the principal advisor to the ASCC commander and ASCC G-8 on all aspects of financial management operations. The FMC provides technical oversight of all Army financial management operations in the theater to include negotiations with HN banking facilities, advising unit commanders on the use of local currency, and coordination with national providers (US Treasury, Defense Finance and Accounting Service [DFAS], Assistant Secretary of the Army for Financial Management and Comptroller and United States Army Finance Command [USAFINCOM]) to establish financial management support requirements. The FMC sustains Army, joint and multinational operations by providing timely contractual and procurement payments and a theater disbursing capability.

k. The Contracting Support Brigade (CSB) is assigned to the Army Contracting Command but allocated to each ASCC. The CSB provides theater support contracting services, along with contracting advice and assistance, primarily to Army forces and to joint forces when directed, and is organized along functional lines. CSBs are more than just a contracting services provider; they provide key OCS capabilities to include contracting support planning assistance, contracting oversight and fraud, waste and abuse prevention. CSB primary tasks include—

- (1) Planning and executing theater support contracting services.
- (2) Providing contract support related advice and planning assistance.
- (3) Coordinating and de-conflicting common contracting support actions.

l. SDDC Transportation Brigades are GCC aligned and provide single port management functions in an area of operations. SDDC serves as the Army Service Component command of USTRANSCOM and is a major subordinate command to Army Materiel Command. The brigade works with commercial transportation industry as a coordinating link between DOD surface transportation requirement to move equipment to and from home station to point of need or retrograde of materiel from deployed locations to home station.

m. In an environment of rapid change and limited resources, the military must respond quickly and efficiently to situations around the world. To deal with this, the U.S. Transportation Command (USTRANSCOM) developed Joint Task Force – Port Opening (JTF-PO) in 2005 to rapidly open and establish ports of debarkation and initial distribution networks to support joint operations and multinational operations. The command is stationed at Fort Eustis, VA, and assigned to TRANSCOM, with OPCON or TACON to the GCC upon employment.

### Section III

#### National Logistics Organizations—Other

##### 11-9. Other Logistics–Related Organizations

a. Sustainment Center of Excellence, formerly Combined Arms Support Command (CASCOM) a subordinate command of TRADOC, has the mission to train, educate and grow adaptive sustainment professionals; develop and integrate innovative Army and Joint Sustainment capabilities, concepts and doctrine to enable Unified Land Operations (ULO). CASCOM's three core competencies are to—

- (1) Execute Initial military training for sustainment Soldiers and civilians.
- (2) Prepare the Army to sustain FSO in a Joint Interagency Intergovernmental Multinational (JIIM) environment.
- (3) Design, develop, and integrate sustainment capabilities into warfighting requirements, foster innovation, and lead change for the future force.

(4) Responsible for command and control of the Defense Ammunition Center, a technical center for munitions where the next generations of civilian ammunition specialists are trained. Additionally, this organization houses the United States Army Technical Center for Explosive Safety (USATCES).

b. U.S. Army Forces Command (FORSCOM). FORSCOM is responsible for the administrative control of all Army forces in CONUS.

c. Army Service Component Command (ASCC). Logistics in a theater of operations is tailored to support

the Joint Force Commander's (JFC) requirements for each situation. Consideration is given to the variety of missions, which tend to make each logistics requirement different in terms of amounts and types of supplies, maintenance, transportation, and services needed. Consequently, organizations are tailored to each theater to cover a full spectrum of possibilities ranging from a large theater of operations comprised of one or more corps to support levels required by a division or separate brigade. The ASCC is responsible for providing administrative control (that includes logistics support) to all Army units and contractors in the theater. This responsibility is executed through the TSC or a functional command such as personnel, transportation, medical, or engineer commands. The Army commander manages theater logistics support by establishing broad policies, allocating critical supplies, and assigning missions in concert with the JFC's guidance. Additionally, the Army theater commander manages and controls supply, maintenance, and other logistics services through the TSC and provides for centralized movements control for U.S. Army forces through the Theater Movement Control Agency (TMCA).

d. Army and Air Force Exchange Service (AAFES). AAFES is the provider of supply Class VI (personal demand items) for the Army and Air Force. It is a joint command of the Departments of the Army and Air Force. The AAFES commander is responsible to the AAFES Board of Directors (BOD). In turn, the BOD is responsible to the Secretaries of the Army and Air Force through their respective chiefs of staff. Primarily a civilian-run organization under military leadership, AAFES employs about 52,400 people, and operates approximately 1,500 facilities worldwide. AAFES worldwide headquarters is located in Dallas, Texas and two subordinate headquarters manage operations within the Europe and Pacific Regions. The mission of AAFES is to provide merchandise and services of necessity and convenience to authorized patrons at uniformly low prices, and to generate funds to supplement Appropriated Funds (APF) for the support of MWR programs. AAFES does this in peace and wartime. To accomplish its mission, AAFES:

(1) Operates retail, food, personal service, vending centers, theaters, automotive facilities, and Army military clothing sales stores on military installations.

(2) Provides basic exchange support to military personnel engaged in contingency operations or field exercises by establishing military-run tactical field exchanges (TFEs) where regular AAFES operations are not possible. Class VI support in the field can be limited to basic health and hygiene needs or expanded to include food, beverages, and other comfort items based upon the requested needs of the theater commander.

(3) Generates earnings that support MWR programs. AAFES pays dividends to the Army, which in turn allocates funds to specific MWR programs on installations. The Army MWR BOD, which is formed under the Army Community and Family Support Center (CFSC), controls the allocation of AAFES-generated MWR funds within the Army.

e. General Services Administration (GSA). The GSA provides general supplies and services that are common to more than one department of the Government. The GSA has multi-mission responsibility to manage the varied business activities of the Federal Government. GSA provides an extensive amount of supply support to the DOD for such commonly used items as leased commercial-style vehicles, office furniture and supplies, machine and hand tools, photo supplies, etc.

## 11-10. Defense Logistics-Related Organization

a. Defense Logistics Agency (DLA).

(1) As America's combat logistics support agency, DLA provides the Army, Marine Corps, Navy, Air Force, other federal agencies and partner nation armed forces with a full spectrum of logistics, acquisition and technical services. DLA sources and provides nearly all of the consumable items America's military forces need to operate – from food, fuel and energy to uniforms, medical supplies and construction material. DLA also supplies nearly 90 percent of the military's spare parts, manages the reutilization of military equipment, provides catalogs and other logistics information products, and offers document automation and production services to a host of military and federal agencies. Headquartered at Fort Belvoir, Virginia, DLA is a global enterprise – wherever the United States has a significant military presence, DLA is there to support.

(2) The DLA's primary activities are—

(a) DLA Land and Maritime, Columbus, OH. Manages weapons system supply chains and is the largest Inventory Control Point (ICP). DLA Land and Maritime's core functions include monitoring inventory levels, maintaining technical data, and assuring quality of more than two million spare and repair parts. DLA Land and Maritime manages more than two million different items for approximately \$5 billion in annual sales. DLA Land manages wheeled, tracked and heavy vehicle parts; vehicle maintenance kits, power

transmission, engine, suspension components, tires, batteries and small arms parts.

(b) DLA Aviation, Richmond, VA. DLA Aviation operates in 18 stateside locations, supporting more than 1,900 major weapon systems, with focused support to 143 major weapon systems and is the U.S. military's integrated materiel manager for more than 1.1 million repair parts and operating supply items in support of all fixed- and rotor-wing aircraft, including spares for engines on fighters, bombers, transports and helicopters; all airframe and landing gear parts; flight safety equipment; and propeller systems. DLA Aviation industrial support activities are positioned alongside its military customers at Robins Air Force Base, GA.; Tinker AFB OK.; Hill AFB, Utah; Marine Corps Air Station Cherry Point, NC; Naval Air Station North Island, CA.; and NAS Jacksonville, FL. DLA Aviation also manages depot-level repairable procurement operations at Robins, Tinker and Hill Air Force Bases; Naval Supply Systems Command (NAVSUP) Weapon Systems Support, Philadelphia; and at Redstone Army Arsenal, Ala. DLA Aviation also operates an industrial plant equipment repair facility at NAVSUP Weapon Systems Support, Mechanicsburg, PA. DLA Aviation also operates the federal government's only industrial plant equipment facility at Navy Inventory Control Point, Mechanicsburg, PA.

(c) DLA Troop Support, Philadelphia, PA. DLA Troop Support supplies and manages food, clothing and textiles, pharmaceuticals, medical supplies, and construction and equipment supplies in support of America's warfighters worldwide and their eligible dependents. Other customers include America's school children participating in federal school lunch programs, and other non-DOD customers. DLA Troop Support supports nearly every contingency operation, humanitarian relief effort, and every theater of operation.

(d) DLA Energy, Fort Belvoir, VA. DLA Energy provides DOD and other government agencies with comprehensive energy solutions and is designated as the executive agent for bulk fuel. DLA Energy's mission continues to expand, incorporating emerging areas of renewable and alternative methods for satisfying customers' energy needs. Its mission is expanding beyond the role of traditional fuel and energy support as it leverages new technologies. Its business units continue to pursue solar power, hydrogen power, synthetic fuels and other alternative fuel and renewable energy sources as new procurement, research and development initiatives materialize.

(e) DLA Distribution, New Cumberland, PA. DLA Distribution is a combat support agency and the Lead Center for Distribution. DLA Distribution's 26 sites around the world are responsible for the receipt, storage, issue, packing, preservation and transportation of more than four million items.

(f) DLA Disposition Services, Battle Creek, MI. In support of the DLA mission, DLA Disposition Services disposes of excess property received from the military services. The inventory changes daily and includes thousands of items: from air conditioners to vehicles, clothing to computers, and much more. That property is first offered for reutilization within DOD, transfer to other federal agencies, or donation to state and local governments and other qualified organizations. Reutilization means big savings. In the past four years more than \$2.2 billion worth of property was reused each year. Every dollar's worth of property reutilized is a tax dollar saved. DLA Disposition Services also supports disaster relief at home, and humanitarian assistance and foreign military sales programs. DLA Disposition Services' (formerly known as the Defense Reutilization and Marketing Service) mission is to support customers through the reuse, transfer, donation, sale or disposal of excess property.

(g) DLA Strategic Materials, Fort Belvoir, VA. DLA Strategic Materials is the U.S. leading agency for the analysis, planning, procurement and management of materials critical to national security. They are responsible for providing safe, secure and environmentally sound stewardship for strategic and critical materials in the United States National Defense Stockpile (NDS). The stockpile of materials is intended to decrease dependence upon foreign sources of supply during national emergency. DLA Strategic Materials stores 28 commodities with a current market value of over \$1.4 billion at 15 locations in the U.S. Commodities range from base metals such as zinc, cobalt, and chromium to the more precious metals such as platinum, palladium, and iridium. The Congress of the United States has authorized DLA Strategic Materials to sell commodities that are excess to DOD needs. Since 1993, DLA Strategic Materials sales have totaled approximately \$6.6 billion. Sales of excess NDS materials produce revenue for the Treasury General Fund and a variety of defense programs such as the Foreign Military Sales program, military personnel benefits, and the buy-back of broadband frequencies for military use. The sale revenues also fund DLA Strategic Materials operations to make it a self-sustaining organization.

(h) DLA Logistics Information Services, Battle Creek, MI. DLA Logistics Information Service provides interoperable, integrated, quality logistics data and enterprise IT solutions for the Military Services, the DOD, and other federal agencies. DLA Logistics Information Services Cataloging Directorate is the centralized and consolidated cataloging activity for all DOD cataloging. It performs all 12 DOD cataloging

functions and provides direct cataloging services in support of Warfighters, all DOD agencies (both at the wholesale and retail levels), and approximately 50 NATO and other allied nations. It is responsible for operational assignment, life cycle maintenance and collaboration with each of the Services for the 7.4 million National Stock Numbers and all the descriptive data associated with each item of supply.

(i) DLA Document Services, Mechanicsburg, PA. DLA Document Services provides a full portfolio of document services ranging from traditional offset printing, through on-demand output to on-line document services. Further, DLA Document Services is recognized as a transformation agent actively moving the DOD toward the use of on-line documents and services. Initiatives include an on-line customer eBusiness interface, Electronic Document Management CoEs for customer shared capability, Distribute and Print services (e.g., distribution of a digital file to multiple production facilities and print on demand), Equipment Management Solutions (e.g., best-value document support equipment in customer workspaces), and document conversion services (e.g., one of the largest providers in the federal government).

(j) DLA Transaction Services, Wright-Patterson AFB, OH. DLA Transaction Services receives, edits, and routes logistics transactions for the military services and federal agencies for standard Military Supply (MILS) transactions and provide information about anything, anywhere, anytime, to anyone in the DOD and Federal Logistics Community.

(k) DLA Distribution, New Cumberland PA is the leading provider of global distribution support to America's military including receiving, storing and issuing supplies as well as providing other tailored services to increase warfighter readiness. DLA Distribution offers best value supply chain solutions through a broad range of services including storage, distribution, customized kits and specialized packaging as well as transportation support and technology development. DLA Distribution's customers include U.S. Army, Marine Corps, Navy, Air Force and other agencies. More than 10,000 employees provide timely distribution services to customers around the globe. In fiscal year 2013, DLA Distribution processed nearly 16 million receipts and issues supporting customer requirements worldwide, to include Operation New Dawn and Operation Enduring Freedom, numerous humanitarian assistance missions and a multitude of military exercises to ensure warfighter readiness.

b. Defense Contract Management Agency (DCMA) is the DOD component that works directly with Defense suppliers to help ensure that DOD, Federal, and allied government supplies and services are delivered on time, at projected cost, and meet all performance requirements. DCMA provides Contract Administration Services to the DOD Acquisition Enterprise and its partners to ensure delivery of quality products and services to the warfighter; on time and on cost. These services include: Acquisition Planning Support, Contract Management, Financial Services, Engineering Support Services, Property Management, Quality Assurance & Product Acceptance, Software Acquisition Management, Small Business, and Specialized Safety Support. DCMA professionals serve as "information brokers" and inplant representatives for military, federal, and allied government buying agencies -- both during the initial stages of the acquisition cycle and throughout the life of the resulting contracts. Before contract award, DCMA provides advice and information to help construct effective solicitations, identify potential risks, select the most capable contractors, and write contracts that meet the needs of our customers in DOD, federal and allied government agencies. After contract award, DCMA monitors contractors' performance and management systems to ensure that cost, product performance, and delivery schedules are in compliance with the terms and conditions of the contracts.

c. The Defense Contract Audit Agency (DCAA) provides audit and financial advisory services to Department of Defense (DOD) and other federal entities responsible for acquisition and contract administration. DCAA operates under the authority, direction, and control of the Under Secretary of Defense (Comptroller)/Chief Financial Officer. DCAA, while serving the public interest as its primary customer, shall perform all necessary contract audits for the DOD and provide accounting and financial advisory services regarding contracts and subcontracts to all DOD components responsible for procurement and contract administration. These services shall be provided in connection with negotiation, administration, and settlement of contracts and subcontracts to ensure taxpayer dollars are spent on fair and reasonable contract prices. DCAA shall provide contract audit services to other Federal agencies as appropriate.

## **11-11. Department of the Army Approved Accountable Property System of Records (APSRs)**

a. Logistics Management Program (LMP). The LMP provides a comprehensive, modernized logistics solution that allows AMC to provide world class logistics readiness. Operational since July 2003, LMP delivers a fully-integrated suite of software and business processes that streamlines the Maintenance,



Repair, and Overhaul (MRO), planning, finance, acquisition, and supply of weapon systems, spare parts, services, and materiel. Today, LMP is operational at all the AMC LCMCs, Army Sustainment Command (ASC), Defense Finance and Accounting Service (DFAS), and other Army locations. The program manages a multi-billion dollar inventory with tens of thousands of vendors and integrates with more than 70 DOD systems. Now fully fielded, LMP operates at more than 50 locations worldwide with approximately 25,000 users. AMC LMP program has been designated as the Approved Accountable Property System of Record at the Army Wholesale level.

b. Global Combat Support System (GCSS-Army). GCSS-Army provides the tactical logistics and financial data to the ERP program to integrate the repair parts supply stocks, formal property accountability, maintenance and logistics business processes. It also provide an Army view of supply and maintenance information from below the wholesale level. GCSS-Army allows commanders to anticipate, allocate, and synchronize the flow of resources across all areas of operations. GCSS-Army replaces aging, stovepiped tactical logistics systems and associated financial capabilities and interface with applicable Army C2 systems and Joint systems as a follow-on initiative. This Web-based system, supported by laptops and Automatic Identification Technologies (AIT) devices, provides functionality for limited disconnected operations and for connected operations using robust deployable communications to connect to a centralized database for all users at all echelons. GCSS-Army has a Business Intelligence and Business Warehouse (BI/BW) reporting capability featuring Property Book, Maintenance, and Supply Activity.

c. Army Enterprise Systems Integration Program (AESIP). The Army continues to modernize its ERP business systems to simplify operations, optimize processes, and provide an accurate, Enterprise view of business information to all users. AESIP is a key component of this initiative. AESIP integrates business processes and systems by serving as the Enterprise hub for the Army's logistics and financial ERP business systems, to include: LMP, the national logistics system; GCSS-Army, the tactical logistics system; and General Fund Enterprise Business System (GFEBS), the Army's financial system. AESIP enables integration by linking business processes and data across existing IT systems. This integration optimizes business processes and supports Enterprise level information requirements. AESIP has successfully delivered a Web-based solution for the creation and management of customer and vendor master data and implemented an optimized messaging and hub services capability. AESIP houses and enables the Army Enterprise material master which provides the Army a single authoritative source for material data supporting all Army constituent (modernized and legacy) systems. This Army Enterprise material master provides the catalyst to manage, control, create, change, archive, and validate data, while providing a single global view of material thus, providing the basic building blocks for Product Lifecycle Management/Weapon System Management. Implementation of the Enterprise material master has enabled inventory management, accountability, pricing, accounting functions, and Material Requirements Planning (MRP) operations to be seamlessly integrated into the Army Enterprise vision.

d. The LMI Decision Support Tool (DST) is the Army's collaborative tool used to synchronize the distribution and redistribution of materiel IAW Army priorities and directives. DST receives information from the Logistics Information Warehouse (LIW), which is the Army's single authoritative materiel data repository. In order to help provide a common operating picture for distribution and redistribution actions, LIW receives data from sources such as Property Book Unit Supply Enhanced (PBUSE), Global Combat Support System - Army (GCSS-A), Logistics Modernization Program (LMP), Army War Reserve Deployment System (AWRDS), Force Management System Website (FMS-Web) and the Army Equipping Enterprise System (AE2S). Materiel Managers across the Enterprise are able to obtain near real-time asset visibility, develop equipping plans, and project unit readiness.

e. The National Level Ammunition Capability is the DOD visibility tool for Class V, providing joint capability to execute material visibility and management for all Services' munitions on both the unclassified and classified sides.

## Section IV

### Summary, Key Terms, and References

#### 11-12. Summary

Army sustainment processes, organizations and management enterprises continue to transform to meet our Nation's challenges and provide unique logistics support to the Joint Force Commander; enabling freedom of action across the range of military operations. Logisticians provide the essential capabilities to

enable the force to Prevent, Shape, and Win.

## 11-13. Key Terms

- a. *Anticipation*. The ability to foresee events and requirements and initiate necessary actions that most appropriately satisfy a response without waiting for operations orders or fragmentary orders.
- b. *Container Management*. The process of establishing and maintaining visibility and accountability of all cargo containers moving within the Defense Transportation System.
- c. *Continuity*. The uninterrupted provision of sustainment across all levels of war.
- d. *Directive Authority for Logistics*. The CCDR's authority to issue directives to subordinate joint force commanders of service component commanders for as many common support capabilities required to accomplish the assigned mission (JP 3-33).
- e. *Economy*. Providing sustainment resources in an efficient manner that enables the commander to employ all assets to the greatest effect possible.
- f. *Improvisation*. The ability to adapt sustainment operations to unexpected situations or circumstances affecting a mission.
- g. *Integration*. Combining all of the sustainment elements within operations assuring unity of command and effort.
- h. *Intermodal Operations*. The process of using multiple modes (e.g., air, sea, highway, rail) and conveyances (e.g., truck, barge, containers, pallets) to move troops, supplies and equipment through expeditionary entry points and the network of specialized transportation nodes to sustain land forces.
- i. *Logistics*. Planning and executing the movement and support of forces. It includes those aspects of military operations that deal with: design and development, acquisition, storage, movement, distribution, maintenance, evacuation, and disposition of materiel; acquisition or construction, maintenance, operation, and disposition of facilities; and acquisition or furnishing of services.
- j. *Mode Operations*. The execution of movements using various conveyances (truck, lighterage, railcar, aircraft) to transport cargo.
- k. *Movement Control*. The dual process of committing allocated transportation assets and regulating movements according to command priorities to synchronize distribution flow over lines of communications to sustain land forces.
- l. *Personnel Services*. Sustainment functions that man and fund the force, maintain Soldier and Family readiness, promote the moral and ethical values of the nation, and enable the fighting qualities of the Army.
- m. *Port Opening*. The ability to establish, initially operate and facilitate throughput for ports of debarkation (POD) to support unified land operations.
- n. *Responsiveness*. The ability to react to changing requirements and respond to meet the needs to maintain support.
- o. *Simplicity*. Relates to processes and procedures to minimize the complexity of sustainment.
- p. *Sustainment*. The provision of logistics, personnel services, and health service support necessary to maintain operations until successful mission completion (ADP 4-0).
- q. *Sustainment Preparation of the Operational Environment*. The analysis to determine infrastructure, physical environment, and resources in the operational environment that will optimize or adversely impact friendly forces means for supporting and sustaining the commander's operations plan.
- r. *Sustainment Warfighting Function*. The related tasks and systems that provide support and services to ensure freedom of action, extended operational reach, and prolong endurance (ADRP 3-0).
- s. *Theater Closing*. The process of redeploying Army forces and equipment from a theater, the drawdown and removal or disposition of Army non-unit equipment and materiel, and the transition of materiel and facilities back to host nation or civil authorities.
- r. *Theater Distribution*. The flow of equipment, personnel, and materiel within theater to meet the CCDR's mission.
- t. *Theater Opening*. The ability to establish and operate ports of debarkation (air, sea, and rail), establish a distribution system and sustainment bases, and to facilitate port throughput for the reception, staging, onward movement and integration of forces within a theater of operations.

## 11-14. References

- a. Publications. Field manuals and selected joint publications are listed by new number followed by old number.

- (1) Joint Publications. Most joint publications are available online: <http://www.dtic.mil/doctrine/-->.
- (a) JP 1, Doctrine for the Armed Forces of the United States, 25 Mar 2013.
  - (b) JP 1-02, Department of Defense Dictionary of Military and Associated Terms, 8 Nov 2010 (amended 15 Jun 2015).
  - (c) JP 1-06, Financial Management Support in Joint Operations, 2 Mar 2012.
  - (d) JP 2-03, Geospatial Intelligence Support to Joint Operations, 31 Oct 2012.
  - (e) JP 3-0, Joint Operations, 11 Aug 2011.
  - (f) JP 3-08, Interorganizational Coordination During Joint Operations, 24 Jun 2011.
  - (g) JP 3-28, Civil Support, 31 Jul 2013.
  - (h) JP 3-33, Joint Task Force Headquarters, 30 Jul 2012.
  - (i) JP 3-34, Joint Engineer Operations, 30 Jun 2011.
  - (j) JP 3-35, Deployment and Redeployment Operations, 31 Jan 2013.
  - (k) JP 4-0, Joint Logistics.
  - (l) JP 4-01, Joint Doctrine for the Defense Transportation System, 6 Jun 2013.
  - (m) JP 4-01.5, Joint Terminal Operations, 6 Apr 2012.
  - (n) JP 4-02, Health Service Support, 26 Jul 2012.
  - (o) JP 4-06, Mortuary Affairs, 12 Oct 2011.
  - (p) JP 4-08, Logistics in Support of Multinational Operations, 21 Feb 2013.
  - (q) JP 4-09, Distribution Operations, 19 Dec 2013.
  - (r) JP 4-10, Operational Contract Support, 16 Jul 2014.
  - (s) JP 5-0, Joint Operation Planning, 11 Aug 2011.
- (2) Army Publications. Most Army doctrinal publications are available online: <http://www.apd.army.mil/-->.
- (a) Army Doctrine Publication (ADP) 3-0 (FM 3-0), Unified Land Operations, 10 Oct 2011.
  - (b) ADP 4-0 (FM 4-0), Sustainment, 31 Jul 2012.
  - (c) ADP 5-0, The Operations Process, 17 May 2012.
  - (d) ADP 6-0, Mission Command, 17 May 2012 with Changes 1 and 2.
  - (e) Army Doctrine Reference Publication (ADRP) 1-02, Operational Terms and Graphics, 2 Feb 2015 (replaced FM 1-02).
  - (f) ADRP 3-0, Unified Land Operations, 16 May 2012.
  - (g) ADRP 4-0, Sustainment, 31 Jul 2012.
  - (h) ADRP 5-0, The Operations Process, 17 May 2012.
  - (i) ADRP 6-0, Mission Command, 17 May 2012, with changes 1 and 2.
  - (j) AR 11-1, Command Logistics Review Program, 27 Nov 2012.
  - (k) AR 11-2, Managers' Internal Control Program, 26 Mar 2012.
  - (l) AR 27-10, Military Justice, 3 Oct 2011.
  - (m) AR 30-22, The Army Food Program, 24 Jul 2012.
  - (n) AR 700-8, Logistics Planning Factors and Data Management, 15 Mar 2011.
  - (o) AR 700-80, Army IN-Transit Visibility, 24 Sep 2008.
  - (p) AR 700-131, Loan, Lease, and Donation of Army Materiel, 23 Aug 2004.
  - (q) AR 700-137, Logistics Civil Augmentation Program (LOGCAP), 28 Dec 2012.
  - (r) AR 702-6, Ammunition Stockpile Reliability Program, 2 Dec 2016.
  - (s) AR 710-2, Supply Policy Below the National Level, 28 Mar 2008.
  - (t) AR 711-6, Army Participation in the Defense Logistics Agency Weapon System Support Program, 15 May 2009.
  - (u) AR 715-9, Operational Contract Support Planning and Management, 20 Jun 2011.
  - (v) AR 735-5, Property Accountability Policies, 10 May 2013.
  - (w) AR 750-1, Army Materiel Maintenance Policy, 12 Sep 2013.
  - (x) Army Techniques Publication (ATP) 4-0.1, Army Theater Distribution, 29 Oct 14.
  - (y) ATP 4-90, Brigade Support Battalion, 2 Apr 2014.
  - (z) ATP 4-91, Army Field Support Brigade, 15 Dec 2011.
  - (aa) ATP 4-92, Contracting Support to Unified Land Operations, 15 Oct 2014. (cc) ATP 4-94, Theater Sustainment Command, 28 Jun 2013.
  - (bb) ATP 4-15, Army Watercraft Operations, 3 Apr 2015.
  - (cc) ATP 4-33, Maintenance Operations, 14 Apr 2014.
  - (dd) ATP 4-42 – General Supply and Field Services Operations, 14 Jul 2014.

## HOW THE ARMY RUNS

- (ee) DA Pamphlet 735-5, Property Accountability Procedures and Financial Liability Officer's Guide, 23 Mar 2016.
- (ff) Field Manual (FM) 1-0, Human Resources Support, 1 Apr 2014.
- (gg) FM 1-04, Legal Support to the Operational Army, 18 Mar 2013.
- (hh) FM 1-05, Religious Support, 5 Oct 2012.
- (ii) FM 1-06, Financial Management Operations, 15 Apr 2014.
- (jj) FM 3-04.111, Aviation Brigades, 7 Dec 2007.
- (kk) FM 3-05, Army Special Operations Forces, 9 Jan 2014.
- (ll) FM 3-28, Civil Support Operations, TBP.
- (mm) FM 3-34, Engineer Operations, 2 Apr 2014.
- (nn) FM 4-02, Army Health System, 26 Aug 2013.
- (oo) FM 4-95 Logistics Operations, 1 Apr 2014.
- (pp) FM 27-10, The Law of Land Warfare, 18 Jul 1956.
- (rr) HQDA General Order, 2017-01, Assignment of Functions and Responsibilities within Headquarters, Department of the Army, 5 Jan 2017.

## Chapter 12

### Military Human Resource Management

#### Section I Introduction

##### 12-1. Military Human Resource Management

The term Human Resource Management (HRM) has been accepted by the Army leadership and, over time, has been integrated into policy and doctrine formerly used to describe the functions of personnel management and personnel administration. In the most general sense, HRM is a series of integrated decisions about the employment relationship that influences the effectiveness of employees and organizations. Military Human Resource Management (MHRM) is the major component of the Army's overall HRM operations. It has evolved from a supporting role to that of a strategic enabler for the Army. Today's challenges require informed decisions on force structure requirements, recruiting and retention programs, well-being programs, and personnel readiness from both individual and unit perspectives. HR leaders must possess professional and specialized skills to meet these challenges and manage the programs that comprise the functions and integrating systems of the HR life cycle model.

##### 12-2. Military Human Resource Life Cycle Functions

In a broad sense, MHRM describes the process of managing people by performing the essential functions of planning, organizing, directing, and supervising effective procedures necessary in administration and operation of personnel management. The life cycle HR management functions are derived from the Army's life cycle, as follows.

- a. Personnel Structure. The HR portion of the Army's force development function where personnel requirements and authorizations are determined and documented.
- b. Acquisition. This function ensures the Army is staffed with the correct grades and skills in numbers sufficient to satisfy force requirements, and has three components.
  - (1) Manpower Management. The process of linking accession, retention, and promotion targets to Army requirements as measured against the military manning program in the Planning, Programming, Budgeting, and Execution (PPBE) process.
  - (2) Accession and Retention Management. The process that converts manpower targets to missions and oversees execution.
  - (3) Training Integration. The establishment of a demand for training programs and a system to control input and tracking of trainees and students.
- c. Distribution. The function of assigning available Soldiers to units based on Army requirements and priorities.
- d. Development. This function begins with accession training and continues throughout a Soldier's entire period of service. It includes institutional training, self-development, leader development, and supporting programs such as the voluntary education, evaluation, promotion, and command selection systems.
- e. Deployment. This function enables the Army to transition from the "prepare mode" to the "conduct of military operations" mode. Deployment includes mobilization, deployment, redeployment, demobilization, reset, non-combatant evacuation, and repatriating.
- f. Compensation. This function encompasses the management of all pay, allowances, benefits, and financial entitlements for Soldiers, retirees, and annuitants. The dollars involved exceed one-third of the Army's total obligation authority.
- g. Sustainment. This function involves the management of programs to maintain and advance the well-being of Soldiers, civilians, retirees, and family members.

h. Transition. As individuals leave the Active Component (AC) for either the Reserve Components (RC) or civilian life, this function provides assistance to Soldiers, Army civilians, and family members.

### 12-3. Human Resource Leadership

a. Assistant Secretary of the Army (Manpower and Reserve Affairs) (ASA(M&RA)) has principal responsibility for the overall supervision of manpower, personnel, and RC affairs.

b. The Deputy Chief of Staff, G-1 (DCS, G-1), as the Army's personnel proponent, determines the broad objectives of the military personnel management system. The DCS, G-1 establishes policy for and exercises Army staff (ARSTAF) proponent supervision of the system's functions and programs.

c. The Commanding General (CG), U.S. Army Human Resources Command (HRC) is the Army's functional proponent for the military personnel management system and operates the Army's military HR systems within the objectives set by the DCS, G-1. The CG, AHRC also supports the MHRM system's automation requirements in the design, development, and maintenance of personnel databases and automation systems.

d. The CG, U.S. Army Soldier Support Institute (USASSI) develops and coordinates operational concepts, materiel requirements, organization and force design requirements, and integrates training into courses of instruction at the Adjutant General School.

### 12-4. Key Military Human Resource Publications

a. Army Regulation (AR) 600-8, Military Personnel Management. This regulation establishes the military personnel management system. It describes the functional structure of the system and sets forth the organizational structures that direct, integrate, and coordinate the execution of the system. The AR 600-8 series addresses specific subjects within the military personnel management arena.

b. Field Manual (FM) 1-0, Human Resource Support. This field manual describes the Army's personnel doctrine and how it fits into the Army's operational concept across the full spectrum of conflict, as well as how it supports unit commanders and Soldiers. It provides a common understanding of HR support and encompasses the management concepts of personnel information and readiness; replacement, casualty, and postal operations; personnel accounting and strength reporting; mobilization and demobilization; and other essential personnel services.

c. AR 600-3, The Army Personnel Proponent System.

(1) The Human Resources Command (HRC) manages the personnel proponent system, designating personnel proponents, assigning their basic responsibilities, and defining the personnel life cycle management functions. The objectives of the personnel proponent system are as follows.

(a) Identify a single agent (proponent) responsible for all personnel matters for each career field (officer, warrant, enlisted, and civilian).

(b) Fix responsibility for all career field-related matters.

(c) Ensure the civilian work force is integrated into the personnel proponent system.

(d) Ensure personnel management policies and programs established by Headquarters, Department of the Army (HQDA) incorporate career field-related considerations.

(e) Foster awareness and achievement of the objectives of the Officer Personnel Management System (OPMS), the Total Warrant Officer System (TWOS), the Enlisted Personnel Management System (EPMS), and the Civilian Integration into the Personnel Proponent System (CPMS).

(2) The functions of personnel proponentcy are accomplished through approximately 54 personnel proponent offices in conjunction with HRC. Together the proponents assist the DCS, G-1 in all personnel-related matters.

(3) The framework for proponentcy consists of the eight life cycle management functions. The personnel proponent system serves as the honest broker, ensuring fairness, completeness, accuracy, and timeliness of all aspects of the personnel system.

### 12-5. Military Occupational Classification and Structure System

a. The MOCS system translates manpower requirements into specific skills and grade levels. System policy is set forth in AR 611-1, Military Occupational Classification and Structure Development and Implementation. Department of the Army Pamphlet (DA PAM) 611-21, Military Occupational Classification and Structure, contains the procedures and detailed officer, warrant officer, and enlisted classification and structure guidance. AR 611-1 publication is available as an electronic publication on the U.S. Army Publishing Agency (USAPA) web site ([www.usapa.army.mil](http://www.usapa.army.mil)). DA PAM 611-21 is a living

document and is available on milSuite website (<https://www.milsuite.mil/book/groups/smartbookdapam611-21>).

b. Changes to occupational identifiers within the MOCS are generally driven by the requirements determination process. Personnel proponents submit proposed changes to the system in accordance with responsibilities in AR 600-3 for recommending classification criteria. The Personnel Occupational Specialty Code Edit (POSC-Edit) System, an automated system maintained by Deputy Chief of Staff, Personnel (DAPE-PRP), is the official military occupational edit file used to edit and update data on authorized automated personnel systems. The file is updated based on approved revisions to the MOCS. It contains a listing of all authorized commissioned officer, warrant officer, and enlisted identifiers; grades associated with those identifiers; and other personnel information.

### 12-6. Interrelated Documents and Systems at the Heart of Human Resource Process

a. The Active Army Military Manpower Program (AAMMP). The manpower program is produced as monthly updates and as decision programs for the Program Objective Memorandum (POM), Office of the Secretary of Defense (OSD) budget submission, and President's Budget. It is the report produced by the Enlisted Grades (EG) Model. Using a linear program, the EG Model operates within constraints such as end strengths, man years, and recruiting capability to develop an operating strength (OS) that matches the Force Structure Allowance (FSA) as closely as possible. It also carries up to seven years of historical loss behavior to use as a projective (predictive) database. Inputs are the latest available strength, gains, and loss data. Vital data for the AAMMP comes from (or will come from) several manpower systems, most of which are discussed later in this chapter. These systems include the suite of forecasts that constitute the Officer Forecasting Model (OFM); Enlisted Specialties Model; the Individual Account (IA) Model; and the Army Training Requirements and Resources System (ATRRS). The AAMMP records and/or projects strength of the Army; losses and gains; FSA; training inputs; officer, cadet, and female programs; and the trainees, transients, holdees, and students (TTHS) account.

b. Total Army Personnel Database (TAPDB). An automated, standardized database containing military personnel data to fully support manning and sustaining functions during peacetime and under mobilization required by HRC and the National Guard Bureau (NGB). It consists of integrated but physically distributed databases (Active Officer (TAPDB-AO), Active Enlisted (TAPDB-AE), United States Army Reserve (USAR), Army National Guard (ARNG), and Core). TAPDB core contains selected data elements from each component database needed to support mobilization.

c. Electronic Military Personnel Office (eMILPO). This web-based automated personnel information system is the Army's database of record and primary HR system. eMILPO provides commanders with management information reports; performs automated field records maintenance; and provides automated personnel information to TAPDB (AE, AO), the Enlisted Distribution and Assignment System (EDAS) Active Enlisted (AE) and Total Officer Personnel Management Information System (TOPMIS) (AO). eMILPO is web based, uses a centralized database and provides near real-time, Army-wide visibility on personnel information.

d. Enlisted Specialties Model. This is part of the HQDA decision support system. It is personnel planning optimization model that computes recommended Military Occupational Specialty (MOS) and grade mix, enlisted accessions, training to support accessions, and in-service reclassification/reenlistment and promotions to maintain force alignment through the POM cycle.

e. OFM. The OFM uses time-series forecasting techniques to demonstrate the aggregate impact of current proposed manpower policies. It maintains force alignment by minimizing the difference between the desired and projected OS in each competitive category and grade. The major inputs are authorizations data, inventory data, loss rates, and promotion targets. The model provides output data that can be imported into spreadsheets or word processing documents for analysis and reporting. The OFM outputs support program and budget development, policy analysis, and other management activities and serves as an input or constraint into EG.

f. Active Army Strength Forecaster (A2SF). This system developed and used by DCS, G-1, replaced several legacy systems used in forecasting officer and enlisted strengths, gains, losses, and force manning. Using updated methodologies, the object-oriented design of this system provides more accurate and timely forecasting, as well as significantly enhanced detail (rates for specific populations, gender, etc.) to support DCS, G-1 decisions. It draws upon TAPDB for personnel source data and produces the AAMMP as one of its primary reports.

g. ATRRS. ATRRS is the Army's system of record for training. It is an automated information system that provides personnel input to training management information for HQDA, commands, schools, and training centers during both peacetime and mobilization operations. The system contains information at the course level of detail on all courses taught by and for the Army. A major product of ATRRS is the Army Program for Individual Training (ARPRINT).

h. ARPRINT. The ARPRINT is a mission document that provides officer and enlisted training requirements, objectives, and programs for the Active Army (AA), Army RC, Department of the Army (DA) civilians, other U.S. Services, and foreign military. Training is planned and executed on a FY basis and the goal is to train sufficient numbers in each MOS/branch and functional area to equal the projected authorizations as of the end of the FY.

### Section II The Structure Function

#### 12-7. Military Manpower Management

In Chapter 3, we addressed unit structure and force planning, describing how the force is sized and configured and how that force is accounted for in the documentation system. This paragraph, which should be viewed as an extension of Chapter 3, will focus on how the Army manages manpower and personnel once the force is configured and sized.

a. Manpower management at the macro level is the function of determining requirements, obtaining manpower, and allocating resources. It includes the determination of minimum-essential requirements, alternative means of providing resources, and policies to be followed in utilization of manpower. It involves the development and evaluation of organizational structure and review of utilization. It includes Soldiers in the AC, ARNG, and USAR, Army civilian manpower assets, and certain contractor assets when a requirement is satisfied by contractual services rather than by Army military or civilian personnel.

b. Manpower managers deal with HR requirements from the perspective of the organizational structure in which they will be most efficiently and economically used. First, they focus on requirements demanding explicit grades and skills to perform specific tasks. Then, they focus on determining which requirements will be supported with authorizations (spaces). Finally, they combine force structure authorizations with requirements in the TTHS Account, also referred to as the IA, to determine the needs of the Army by grade and skill within constraints that exist. Simultaneously, HR managers focus on supporting requirements through the acquisition, training, and assignment of personnel (faces) to authorized positions.

c. The Congress, the Office of Management and Budget (OMB), OSD, and the Office of the Secretary of the Army (OSA) are not directly involved in the management of individual military personnel. They do, however, establish policies that prescribe the availability of this resource and the management latitude available to those involved in personnel management. For example, policies which limit Permanent Changes of Station (PCS), establish tour lengths, set officer grade limitations, or place a ceiling on the hire of local national personnel affect the flexibility of personnel managers. OSD and, to a more limited extent, OMB, are involved in the force-structuring process. Managers, above the DA level, are concerned primarily with the management of spaces, while at descending levels below HQDA, they are increasingly concerned with the management of people and their associated costs. Much of the work at the departmental level involves decisions dealing with the aggregate of the force structure and inventory rather than the subsets of grade and skill. At lower levels, the HR process turns its focus more toward the faces and the management of people. Whenever the force structure changes, there is a significant cause and effect relationship on the many systems that support manpower planning and HR management.

#### 12-8. Manpower Management at Headquarters, Department of the Army

a. In managing military manpower at the macro level, the key measurement used by HR managers is the Operating Strength Deviation (OpSD). OpSD is a measurement of how much the OS (faces) is deviating from the FSA (spaces). The OS must not be confused with the FSA. The anticipated size of the OS, however, gives a good idea as to how large a structure can realistically be manned. Throughout the year there can be many causes for these deviations, such as unpredicted changes in retention rates and seasonal surges in acquisitions. Personnel managers must constantly monitor the OpSD and adjust personnel policies to ensure the Army has an optimum match of faces to spaces. At the same time, the





e. By knowing the TTHS and total strength projections, manpower planners can easily determine the size of the OS and use that as a basis for developing a FSA for building authorized units. TTHS, FSA, and OSD projections are all contained in the AAMMP.

f. The number of personnel in the TTHS is often directly attributable to the personnel policies in effect. Soldier casualties, fill of projected deploying units, and training requirements and policies are but a few examples of policies which affect the size of TTHS. Since TTHS has a direct effect on the faces available for FSA manning, these same policies have a direct impact on the number of units and organizations which the Army can field. Thus, manpower and personnel managers face a constant challenge to ensure a balance exists between the use of authorized spaces and the acquisition, training, and distribution of personnel assets to meet the needs of the Army. The stated personnel needs of the Army as expressed in its various organizational documents change on a daily basis as different units and organizations are activated, inactivated, or changed. However, the process of providing personnel to meet these changing needs is much slower.

### **12-9. Personnel Management Authorizations Document and Updated Authorizations Document**

a. The Personnel Management Authorizations Document (PMAD) and Updated Authorizations Document (UAD) are the Army's documents of record for active component military authorizations. The PMAD and UAD provide authorizations data at the Unit Identification Code (UIC), MOS, and grade level of detail for the current year through the end of the program. The PMAD and UAD support the distribution of personnel, strength forecasting, programming, budgeting, accessions, promotions, and training.

b. The primary inputs to the PMAD and UAD are built from annual updates of the force structure files reflected in the HQDA Deputy Chief of Staff, G-3/5/7 (DCS, G-3/5/7) Force Management Division, to include: Structure and Manpower Allocation System (SAMAS) and Army authorization documents files. A PMAD is based on a locked SAMAS file. A normal year sees two locked SAMAS files and two corresponding PMADs. In between command plans, decisions are often made which cause significant changes to authorizations. A UAD which makes adjustments to PMAD authorizations is produced periodically to capture such changes. The Army will publish UADs to capture emerging changes to personnel structure. A normal year sees the publication of two UADs. The personnel community uses PMAD and its most current UAD as the sole source of AC authorizations to UIC, MOS, grade, and Additional Skill Identifier (ASI) level of detail for the current and budget years. The focus of the PMAD and UAD is on detail for near-term distribution. The PMAD is the basis for decisions regarding accessions, training, force alignment, promotions, and distribution of personnel. Throughout this text the term PMAD refers to the PMAD itself or its most current UAD.

### **12-10. Notional Force System**

As needed the Army may also publish a NOF. A NOF provides the same authorizations data as a PMAD or UAD—active component military authorizations at the UIC, MOS, and grade level of detail for the current year through the end of the program. The difference is that a NOF reflects force structure or personnel structure decisions that have not received approval. The purpose of a NOF is to support analysis only and its distribution is limited.

### **12-11. Military Force Alignment**

Force alignment is managing changing faces and spaces simultaneously by grade level and Career Management Field (CMF)/MOS—reshaping a force today to also meet tomorrow's needs. The always changing AAMMP, PMAD, and budget are intensively managed monthly for the PPBE six-year cycle; ensuring military personnel strength is skill-qualified and available for distribution. Force alignment strives to synchronize military personnel programs: promotions, recruiting, accessions, training, reenlistment, reclassification, and special and incentive discretionary pay. Simultaneously, every effort is made to provide professional career development consistent with Army force manning levels for qualified Soldiers. Management forums are the Functional Review (FR), personnel functional assessment (PFA), Structure Manning Decision Review (SMDR), Monthly Military Personnel Review (M2PR), Training Resources Arbitration Panel (TRAP), and CMF reviews. Representation in shaping the officer and enlisted forces involves the entire personnel community in varying degrees of programming and execution. Enlisted Strength Model is a major planning tool for enlisted force alignment analysis. The goal: to achieve a PMAD grade-CMF/MOS match to OS for the current year, budget year, and program years.

**Section III**  
**The Acquisition Function**

**12-12. Enlisted Procurement**

a. Based on input from the PMAD (authorizations by skill and grade), TAPDB-AE (skills and grades on hand), and the AAMMP (projected accessions in the aggregate), the Enlisted Specialties Model projects the numbers and training requirements for the various MOSs. This in turn is used to develop the annual program (ANNPRO) and the ARPRINT and feeds the personnel input to the ATRRS which is linked to the Recruit Quota Enlistment System (REQUEST) and the Reenlistment/Reclassification System (RETAIN) (Figure 12-2).

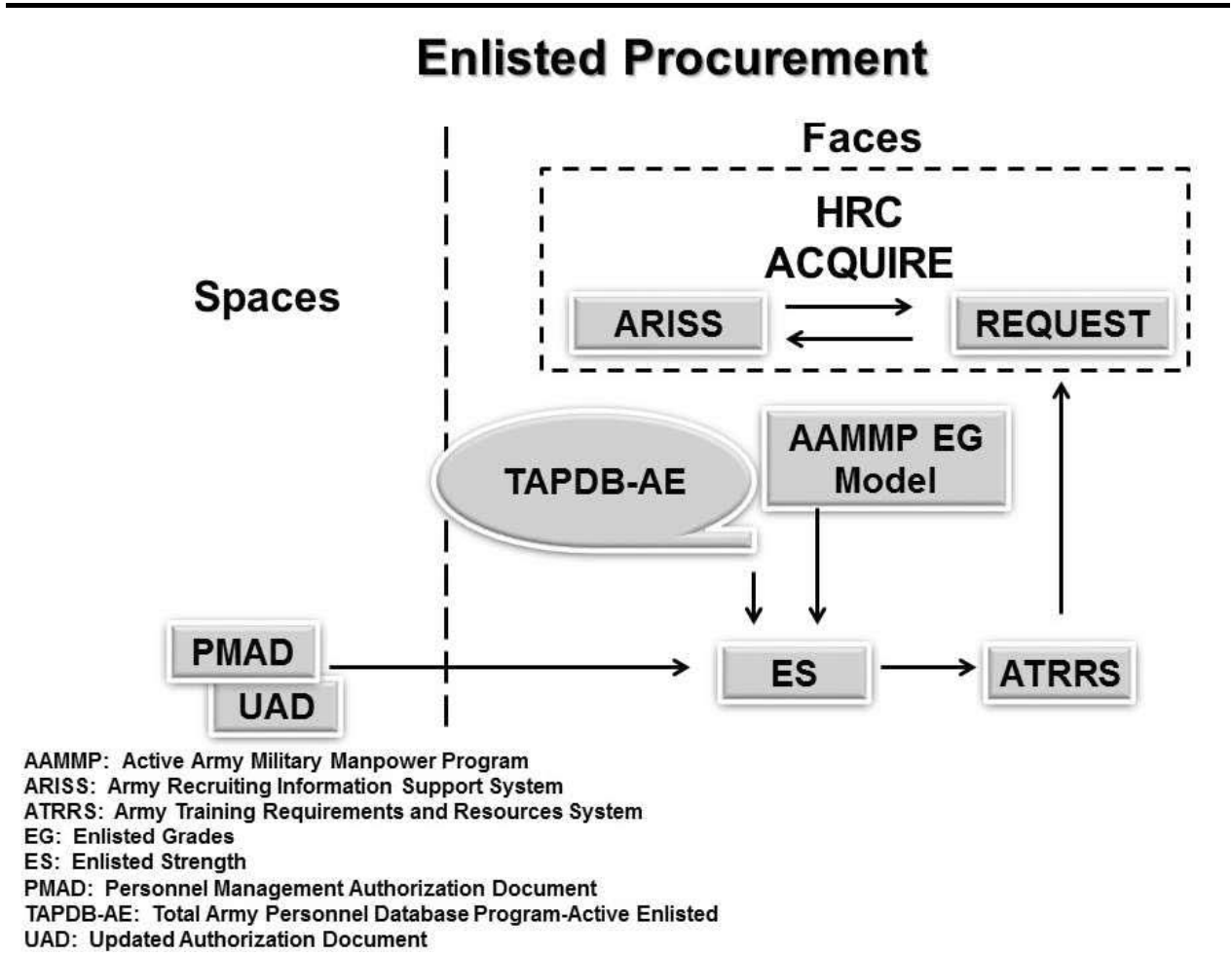

**Figure 12-2. Enlisted Procurement**

b. The mission of the U.S. Army Recruiting Command (USAREC) is to obtain the quantity and quality of recruits to meet both AC and USAR requirements. Active Component enlistment options provide the vehicle by which Army applicants are attracted. The option packages vary and contain such incentives for applicants as training guarantees, unit/station of choice assignments (used primarily for prior service applicants), and payment of bonuses or education incentives. Additionally, the length of the enlistment period varies for certain options and skills.

(1) **Quality Constraints.** The recruiter is constrained by quality standards, which must be met. A potential enlistee is classified as a result of an Armed Services Vocational Aptitude Battery (ASVAB) which has 10 aptitude areas. ASVAB results place individuals into test score categories and determine both basic enlistment and specific MOS eligibility. Both law and Army policy constrain the number of

certain test categories the recruiting force may enlist. The Army Non-Prior Service (NPS) accession quality program seeks to maximize the number of high school diploma graduates and those in the upper test score categories, with a ceiling established for the lower test score categories.

(2) MOS Training Targets. All new Soldiers receive a minimum of 12 weeks of Initial Entry Training (IET) prior to becoming available for deployment. All new Soldiers recruited by USAREC contract for a specific MOS, which is supported by a resourced training seat. Using projections from Enlisted Specialties Model, HRC projects annual IET requirements for new Soldiers in the ANNPRO for each MOS. These requirements then feed into the ATRRS. In ATRRS, IET requirements combine with professional development and other training requirements and are presented at the SMDR for resourcing. Once approved by the Army leadership, all training requirements and approved training programs are identified in the ARPRINT.

(3) Management of Recruiting Objectives. REQUEST is an automated enlistment and training space management system designed to support the Army's recruiting and RC retention missions. The system is a worldwide, real-time, interactive system and is the controlling element for recruiters and RC retention Noncommissioned Officers (NCO) in translating aggregate mission objectives to the MOS needs of the Army. It uses a worldwide telecommunications network with remote data terminals accessing a common data bank containing the Army's training programs determined by the ARPRINT and modified in the year of execution by TRAPs which either increase or decrease the SMDR ANNPRO to meet current requirements. ATRRS provides class schedules and quota allocations to REQUEST, which becomes visible to Army recruiters to enlist Soldiers to fill those quotas. The system provides reservation processing for enlistment options, accession controls, and management information reports from remote data terminals.

(a) REQUEST, designed to enhance the efficiency of Army recruiting, provides the Army with a means of allocating training resources to accessions. Enlistment options during periods of non-mobilization result from a review of the applicant's qualifications based on the ASVAB, physical testing, individual preference, and Army MOS requirements. An automated matching algorithm aligns the applicant's qualifications, desires, and aptitudes to the Army's needs. Qualification checks and other features of the system preclude erroneous enlistments into skills for which the applicant does not qualify.

(b) The REQUEST Unit Distribution Program (RUDIST) adds a unit vacancy and distribution guidance file to the REQUEST System. A portion of the training spaces for MOSs available under an enlistment option guarantees a first assignment is allocated to specific units and stations. Allocations of first assignment are based upon projected unit requirements and distribution policies. This is primarily used for Prior Service Soldiers. For Non-Prior Service applicants, the majority are contracted as uncommitted, providing maximum flexibility to the distribution system to assign them to a unit where they best meet an army requirement.

(c) The REQUEST System is the controlling element for recruiters in translating aggregate recruiting objectives to the MOS needs of the Army.

(4) Military Entrance Processing Station (MEPS).

(a) The MEPS is a jointly staffed Service activity charged with aptitude testing, medical examination, moral evaluation, and administrative processing of applicants for the Armed Forces. DA is the Department of Defense (DOD) Executive Agent for the MEPS. The Military Entrance Processing Command (MEPCOM) commands and controls the MEPS.

(b) Once the recruiter has determined the applicant's desire to enlist and his or her areas of interest, he or she can administer an enlistment screening test which gives an informal indication of how the applicant might fare on the ASVAB. If the applicant continues his or her interest, he or she goes to MEPS for processing.

### 12-13. Warrant Officer Procurement

a. WOs are highly specialized officers, appointed based on technical competence and leadership abilities. USAREC procures warrant officer candidates for the AC. DCS, G-1 develops a recruiting goal by MOS for each FY. USAREC uses this and an internally created lead refinement list, to direct recruiting efforts, especially for hard-skill MOSs with existing or projected critical shortages. Applicants come from the best of the NCO ranks, outside the Army (primarily aviation applicants), other in-service sources such as other Services, commissioned officers, and members of the RC.

b. Applications of all eligible individuals are evaluated by a HQDA selection board. USAREC conducts the board which is composed of a field grade officer president and warrant officer members from each

branch with applicants to be considered. Those recommended by the board on an order of merit list are slated to attend the Warrant Officer Candidate School (WOCS), in a candidate status, as procurement openings present themselves. Each new WO1 then attends the appropriate Warrant Officer Basic Course (WOBC) to complete certification training.

c. The recruitment, application processing, and selection of warrant officers for the USAR is performed in a similar manner as the AC. However, USAREC recruits warrant officer candidates against specific USAR unit vacancies. In addition, USAREC accepts and processes applications for Active Guard Reserve (AGR), Individual Mobilization Augmentee (IMA), and Individual Ready Reserve (IRR) vacancies. The USAR uses boarding and school-slating procedures similar to those used by the AC. The ARNG solicits applications through announcement of vacancies via an internal recruiting effort. The boarding and school-slating procedures are as determined by each individual State Adjutant General. All RC WO applicants attend WOCS and WOBC. RC versions for many WOBCs are available.

#### 12-14. Commissioned Officer Procurement

a. The PMAD is the authoritative source for officer requirements. Authorizations are defined by unit, by Area of Concentration (AOC), and by grade for all grades except WO1. There are no authorizations for WO1s in the U.S. Army. Procurement each year is based on an analysis of the current inventory and the losses projected by the DCS, G-1. This annual procurement number is then disaggregated by HRC into an allocation for each branch. The G-1 then distributes an allocation of branches to each commissioning source. Sufficient officers must be procured each year to ensure an adequate number of trained individuals by grade, AOC, and skill is available for utilization in the future. There are constraints associated with the management of officer end-strength contained in Title 10 United States Code (USC). There is no specific force structure allowance for the officer corps within the authorized end strength of the Army. However, for field grade officers, Title 10 USC restricts the number of officers serving at each grade as a proportion of the size of the officer corps. Training constraints limit the number of officers that can be procured in each branch.

b. Officer Sources. The sources of officer procurement for the basic branches are Officer Candidate School (OCS), Reserve Officers' Training Corps (ROTC), and USMA. Requirements are determined by the DCS, G-1 and filled through the various commissioning programs and special branch programs. To supplement these appointments, recall of reserve officers, recall of retired officers, direct appointments, and inter-service transfers are also used. The inter-service transfer program allows the Army to access members of the Air Force, Navy, Marine Corps, or Coast Guard to fill shortages in the mid-grade ranks and has proven effective as the other services have been decreasing officer strength. All commissioned officers incur a statutory eight-year Military Service Obligation (MSO), which may be supplemented by concurrent or consecutive obligations like those described in AR 350-100. Officers may serve their MSO in a variety of ways depending on the source of their commission as outlined below.

(1) The OCS.

(a) OCS at Fort Benning, Georgia, trains and commissions officers for both the AC and RC. AC OCS graduates incur a three-year Active Duty Service Obligation (ADSO) and may serve the remainder of their eight-year MSO on active duty or in the RC. RC graduates receive a reserve appointment and return to reserve status after completing their initial officer training requirements such as Basic Officer Leaders Course (BOLC) or Airborne or Ranger School. RC graduates not only incur the statutory MSO but must serve six years of that in a Troop Program Unit (TPU) as a drilling reservist.

(b) In-service candidates are enlisted Soldiers serving on active duty. Semi-annual selection boards at HRC select qualified Soldier applicants for OCS. Branches are assigned based on the needs of the Army and candidate's preferences. In-service candidates incur a three-year ADSO within their eight-year MSO.

(c) Enlistment option candidates are qualified college graduates who elect to enlist in the Army in order to attend the OCS. These candidates enlist in the Army and attend basic training followed by the 12-week OCS course. Enlistment option candidates incur a three-year ADSO within their eight-year MSO.

(d) Additionally, each state runs a National Guard OCS to commission officers into the RC.

(2) ROTC. The ROTC trains and commissions officers for both the AC and the RC. Branching is accomplished through Cadet Command and HQDA boards based on the needs of the Army and the cadet's qualifications, standings on the Order of Merit List, and individual preferences.

(a) AC. Upon accession, scholarship cadets incur a four-year ADSO within their eight-year MSO, while non-scholarship cadets incur a three-year ADSO with their eight-year MSO. The remainder of any MSO may be served in the AC or in the RC.

## HOW THE ARMY RUNS

(b) RC. Scholarship cadets must serve in a TPU all eight years of their MSO, while non-scholarship cadets must serve at least six years in a TPU. The remainder of the MSO may be spent in the IRR.

(3) USMA. The USMA trains and commissions officers for the AC. A formal branch selection process matches the needs of the Army with cadet preferences based on a strict order of merit list. The active duty service obligation for USMA graduates is five years and the remainder of the MSO may be spent in the AC or RC.

(4) Special Branches. The special branches—Judge Advocate General's Corps (JAGC), the medical branches, and the Chaplains Corps—procure officers through their individual programs, and service obligations vary depending upon the program. Procurement for most medical officers and Chaplains has been assigned to USAREC while JAGC is responsible for its own recruiting.

### Section IV The Compensation Function

#### 12-15. Compensation Overview

a. Compensation is a relatively recent addition to the military HR life cycle. Over one third of the Army's total obligation authority relates to compensation and only through controlling the cost drivers (number, grade, and skill of Soldiers) can the Army manage the dollars appropriated by Congress.

b. The Army's personnel assets are centrally managed as are Army resources tied to these assets. The Army pays against the inventory (assigned strength), but authorizations and personnel policies are the cost drivers.

c. Personnel management policies, force structure decisions, and content of the force influence the Military Personnel, Army (MPA) appropriation requirement. Among these cost drivers are the following.

- (1) Pay rates
- (2) Retirement rates, including number of medical retirements vice normal retirements, and early retirements (less than 20 years of service)
- (3) Cost of food
- (4) Social Security and Medicare rates
- (5) Basic Allowance for Housing (BAH), including programs similar to
- (6) Residence Communities Initiative (RCI), privatize housing, privatize barracks
- (7) Military Health Care
- (8) Stationing plans and manpower.
- (9) Clothing bag
- (10) Entitlements
- (11) Special Pays (Medical, Aviation, Special Duty Assignment Pay (SDAP), etc.)
- (12) Assignment Incentive Pay (AIP)
- (13) Enlistment bonuses
- (14) State of the Economy
- (15) Reenlistment rates/bonuses
- (16) Separation Pays
- (17) Marital status
- (18) Size of the Army Outside of the Continental United States (OCONUS) and overseas station allowances
- (19) Tour lengths
- (20) Force changes
- (21) Grade and skill content
- (22) Active Duty Operational Support (ADOS)
- (23) Unemployment Compensation
- (24) ROTC pay/scholarships
- (25) Junior ROTC (JROTC) support

d. The MPA account pays the force, moves the force, subsists the force, and supports the force. Pay includes pay and allowances for officers, enlisted, and cadets. Movement is managed under the PCS account, which is sub-divided into accessions, separations, training, operational, rotational, and unit moves. Subsistence provides payment for the basic allowance for subsistence and subsistence in kind.

Finally, support comes in other military personnel costs such as education, adoption, unemployment, death gratuities, and survivor benefit programs.

**12-16. Manning Program Evaluation Group**

At the departmental level, all personnel-related programs are contained within the Manning Program Evaluation Group (PEG). The Manning PEG has responsibility to determine the valid requirements for those programs in Figure 12-3. All should come together in providing the right skills, at the right place and time.

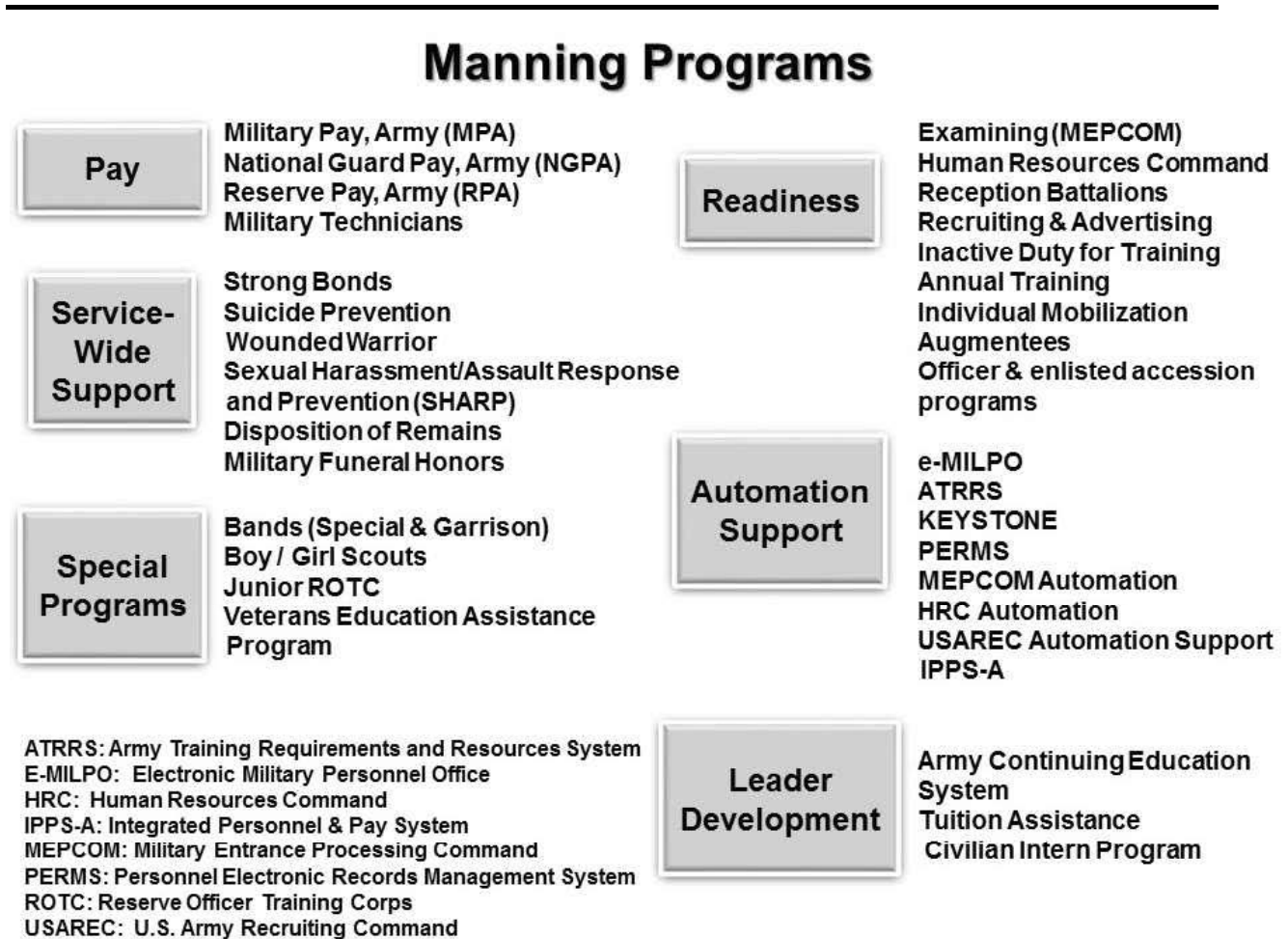

Figure 12-3. Manning Programs

**Section V**  
**The Distribution Function**

**12-17. Enlisted Distribution and Assignment**

a. Distribution Challenge. In theory, the distribution planning and assignment processes place the right Soldier with the right skills at the right place at the right time. In fact, the system does a very credible job for those MOSs and grades which are nearly balanced, those for which the overseas-to-sustaining base ratio is supportable, and for those in which there is a high density of personnel in substitutable skills. The problem arises in the MOSs where these conditions do not exist, and a sharing of shortages is required for all commands. When certain commands, or organizations, are exempted from “shortage-sharing” based upon special guidance, it compounds shortages to be shared by the organizations lower in priority.

The readiness cost of this compounded shortage-sharing comes to light when each organization must assess its mission capable status in the monthly readiness reporting. The personnel component of the report involves several calculations, but its principal factors are assigned strength, available strength, available senior grade personnel (Sergeant (SGT) and above), and MOS qualification.

(1) Enlisted personnel distribution is a very complex business, replete with pitfalls and shortcomings because of the rapidly changing variables that exist—force structure changes, recruiting success, training attrition rates, retention rates, military personnel authorizations, dollar constraints, and most of all, the unpredictability of the individual Soldier, his or her health, and his or her family. All of these variables point up the critical factors which govern successful distribution—the accuracy and timeliness of the databases being used for analysis. Authorizations not approved and posted expeditiously to PMAD and individual change data not properly reported for posting on the TAPDB-AE make the already complicated distribution system less responsive.

(2) Soldiers have the ability to influence their assignment in several ways. One is by submitting an assignment preference. They do so via a web-based application called Assignment Satisfaction Key (ASK), which allows the Soldier to update his/her assignment desires and volunteer for valid requirements directly with HRC in real time.

b. Distribution Planning and Priorities. The basic document that defines priorities for the distribution of enlisted personnel to all units/activities is the FY HQDA Manning Guidance. DCS, G-1 publishes and distributes this guidance to HRC and to Army commands for implementation after the Chief of Staff, U.S. Army (CSA) approves it. The guidance provides responsibilities at all levels for manning units and expected level of fill commands can expect. Distribution is driven by requirements to fill approved authorizations documented in PMAD/UAD, Directed Military Overstrength (DMO), and overstrengths in specific high priority units. Distribution is affected by recruiting and retention goal achievement; unprogrammed losses; and fiscal constraints affecting promotions, PCS movements, and end strength. Special priorities are based on operational and training requirements for special skills, such as Ranger qualifications and linguists.

c. Enlisted Distribution Target Model (EDTM).

(1) The EDTM is an automated system that creates enlisted distribution targets by MOS, grade, and UIC. The model fills each UIC reflected in the PMAD with projected available inventory from the Enlisted Specialties Model in accordance with the DCS, G-1 distribution policy. This results in an optimum distribution of scarce resources consistent with distribution policy fill priorities. The EDTM constrains the assignment process to coincide with the projected OS targets. It represents the assets the Army realistically expects to be available for distribution.

(2) The EDTM is maintained by the Enlisted Readiness Division, Enlisted Personnel Management Directorate (EPMD), HRC. The targets are produced monthly with EDTM targets for grade bands E1-4, E5-8, and E9. Current Month (CM) through CM+18 are visible to field personnel managers via Personnel Network (PERNET) using the EDAS.

d. Management Systems. HRC uses several automated data-processing systems to distribute, manage, and develop active duty enlisted personnel. These systems are described below and reflected in Figure 12-4.

(1) TAPDB is the heart of the overall system. It consists of three logical components containing personnel, requisition, and organizational data. The Personnel (Component of TAPDB) (PER DB) contains personnel information on every active duty Soldier. HRC and DCS, G-1 use this information to determine Army readiness, strength, promotion eligibles, reassignable personnel, and training requirements. The Requisition (Component of TAPDB) (REQ DB) contains information on requirements to move individuals and information on those who have been directed to move (assignments). The Organization (Component of TAPDB) (ORG DB) contains information on location and status of Army units; it does not contain any authorization or unit strength information.

(2) HRC Enlisted Personnel Data Update System (PEPDUS) is one of the major systems used to update the data on the TAPDB. It consists of two components, a batch component and an online, interactive component that allows managers worldwide to query and update personnel data.

(a) The batch component receives transactions daily from other systems. The primary source is eMILPO, but other sources such as the Centralized Promotion System and the EDAS submit transactions. PEPDUS is also designed to support mobilization. During a mobilization scenario it is able to process over 500,000 transactions daily. As PEPDUS updates the TAPDB, it also creates transactions



that are passed back to eMILPO (receipt notices, update transactions, DA error notices, etc.), in order to update the TAPDB-Mobilization (TAPDB-MOB), and provide feedback to other systems.

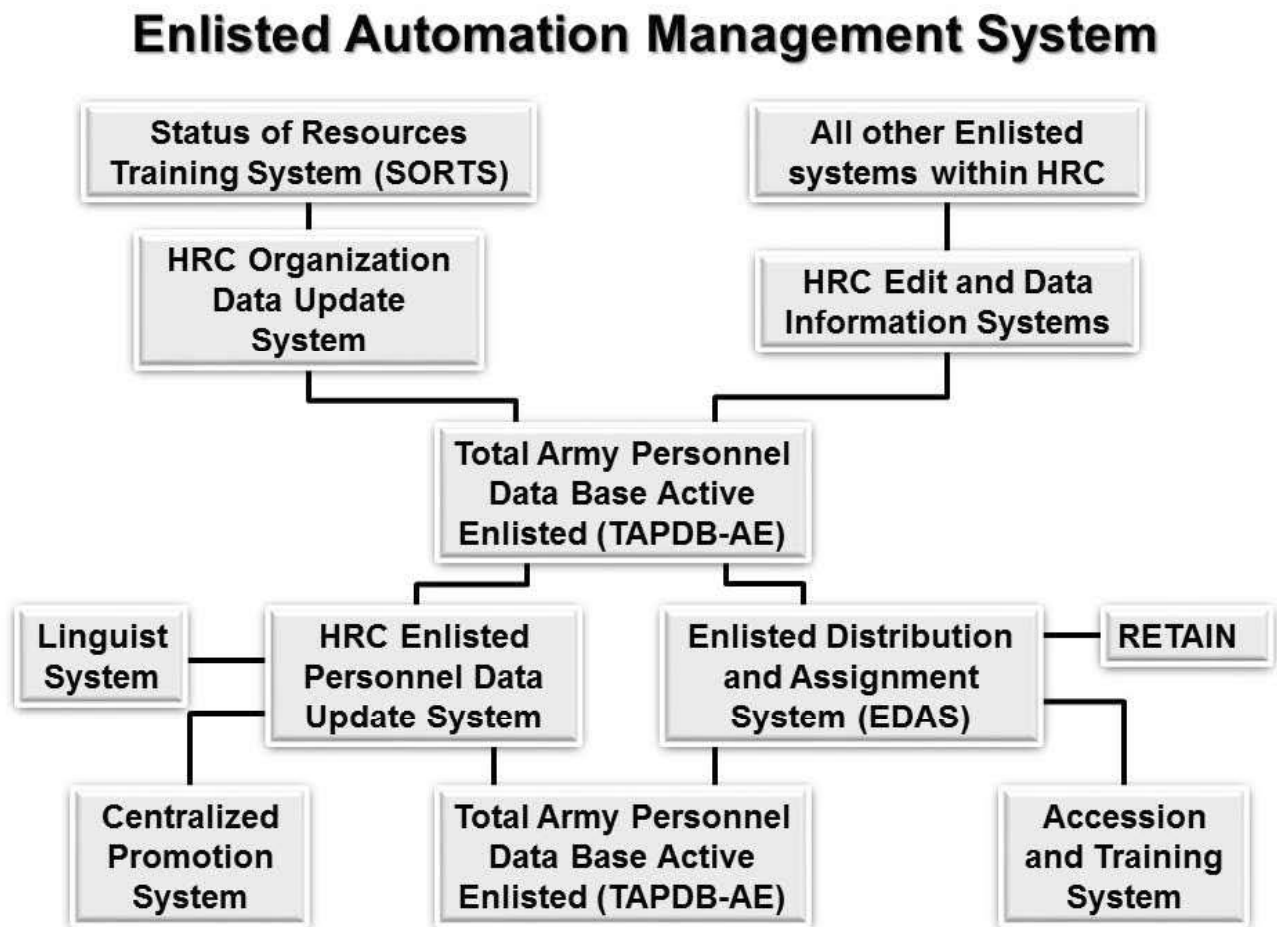

Figure 12-4. Enlisted Automation Management System

(b) The on-line interactive component allows EPMD managers to update data items on the PER DB. Some examples are Continental United States (CONUS) and OCONUS assignment preferences, assignment eligibility, and Date Eligible for Return from Overseas (DEROS). As EPMD managers update, PEPDUS updates the eMILPO Personnel File.

(3) EDAS is an on-line system which allows EPMD managers to create, review, and update requisition and assignment data. It also provides reports for those managers for strength management of the force. It has several batch programs that exchange information with external systems. EDAS allows EPMD distribution and assignment managers to work with one collection of information on the same computer. Under previous systems, updates to information occurred only during the weekend; updates are now instantaneous. Consequently, decisions made by one manager are immediately available to all other managers. Moreover, EDAS provides field users the capability to view and in some cases update the same information that distribution and assignment managers use to make decisions. Finally, EDAS reduces the time to validate a requirement, select a Soldier to fill the requirement, and transmit the assignment instructions to the field. A more detailed explanation on how EDAS is used in distributing and assigning Soldiers is presented in a subsequent section.

### (4) Assignment of Newly Trained Personnel.

(a) Permanent unit assignments are based on input to HRC from basic and advanced individual training centers via the Student/Trainee Management System-Enlisted (STRAMS-E), a module within the ATRRS. Information is passed by ATRRS to EDAS which processes newly trained personnel for assignment.

(b) If an individual has an enlistment agreement for a unit in an area, he or she is assigned according to the enlistment contract upon satisfactory completion of training. Soldiers who have no unit/area options are assigned against requirements in accordance with a distribution plan prepared by HRC. Assignment instructions are generated by EDAS and sent directly to losing commands. The transaction is processed through EDAS and is posted to the TAPDB. EDAS advises the gaining command of the assignment.

e. Enlisted Distribution Management. HRC Enlisted Readiness Division manages the strengths of major overseas commands, Army commands, and special management and functional commands worldwide. HRC established a direct requisition authority to each of the Brigade Combat Team (BCT)/ACRs to ensure projected gains to those organizations were not diverted by installation strength managers. Under modularity and brigade centric organizations, brigades with organic military HR assets will requisition and receive replacements directly from HRC. Strength managers at HRC project the assigned strength of an activity ranging from the current month's strength out to 12 months, and determine how many Soldiers are needed each month to ensure the commands meet targets established by the FY enlisted distribution policy. These aggregate totals (arranged by individual rank and rank bands, i.e., private-specialist, sergeant-staff sergeant, sergeant first class-master sergeant, and sergeant major) are the basis for transition into individual MOS requirements. These top-of-the-system strength managers then determine how many requisitions for replacements should be placed in EDAS, by either directly building the requisitions or coordinating with field commanders.

f. Overseas Requisitions. Requirements for Korea, U.S. Army, Europe (USAREUR), and U.S. Army, Pacific (USARPAC) are analyzed 10 months into the future (eight months for USARPAC). Using the EDTM targets, distribution managers allocate requisitions to each command at the four-character MOS level, allowing commands two weeks to submit requisitions at the nine-character MOS level, including any other special requirements.

### g. CONUS Requisitions.

(1) For CONUS installations, requisitioning is partially constrained through a process known as Requisition Allocation Plan-CONUS (RAP-C). Since fill of vacancies in CONUS commands is partially based on eligible overseas returnees, RAP-C keys on DEROS data in the TAPDB-AE and calculates the number of Soldiers in an MOS and grade who are expected to return to CONUS in a requisition month (two months after DEROS month). CONUS requisitions are normally validated 12 months out. Distributors at HRC, using the EDTM, allocate these Soldiers. If the EDTM requires more requisitions than Soldiers returning from overseas, additional requisitions are loaded, which will require CONUS-to-CONUS moves.

(2) The next effort for HQDA distribution managers is validation, whether for CONUS or OCONUS. If an apparent over or under requisitioning exists, the manager attempts to resolve the discrepancy with the command/installation prior to making a decision to validate, or not validate, requisitions. Discrepancies in the two projections may be caused by a proponent-approved authorization change at the unit level not yet recorded in the Personnel Structure and Composition System (PERSACS), or by more current authorizations data available to HRC through the use of the PMAD, or by more current gain and loss data. The problem is resolved prior to the submission of the validated requisitions for assignment processing in the EDAS.

(3) Distribution managers continually monitor command and installation strength projections and adjust accordingly. Deletions, authorization changes, and other variables may create the need for top loading or canceling requisitions.

h. EDAS. EDAS consists of several major subsystems: management information, requisition, policy, assignment, and personnel.

(1) EPMD distribution managers use the management information subsystem to determine an organization's authorized, assigned, and projected strength. Managers can obtain this information by MOS, skill, CMF, grade, Special Qualification Identifier (SQI), ASI, language, Distribution Management Level/Sub-Level (DML/DMSL), location (installation, state, and country), command, requisition activity code, Troop Program Sequence Number (TPSN), and/or UIC. This information is used to determine the number of valid requisitions needed to maintain that organization at an acceptable strength level.

(2) After the distribution managers determine the number of valid requisitions, the assignment managers must fill them. The policy and nomination subsystems assist assignment managers by recommending which Soldier should be assigned to each requisition and also provide alternate recommendations.

(3) The policy subsystem allows EPMD managers to enter assignments into EDAS that are in accordance with current policies. For example, Soldiers with Homebase/Advanced Assignment Program (HAAP) agreements can only be recommended for assignments which fulfill HAAP agreements.

(4) In addition to making assignments, the assignment subsystem provides the capability to delete or defer Soldiers. If field users have the authority to approve a deletion or deferment, they can complete the action interactively through the assignment subsystem as an alternative to submitting it through eMILPO. If field users do not have the authority to approve the action, they can request a deletion or deferment electronically through EDAS. Throughout this entire process, the field user can interactively monitor the current status of the request.

(5) One important aspect of EDAS is that the system tightly controls access and what the user can do in the system. Some modules allow users to query data, while others allow updates. EDAS controls access by individual user and provides system managers with audit trails which can be used to determine who accessed or changed data in the system. Additionally, EDAS controls which records a user can query and/or update.

(6) The EDAS promotion points update module allows field personnel managers to post promotion point data for Soldiers in grades E4 and E5 directly to the TAPDB. This function allows personnel managers to review and update the information that is resident on the TAPDB. This information is then used by HRC to determine the numbers of promotions for each month by MOS. By using the promotion subsystem, field managers can see those Soldiers, by name, who were considered eligible for promotion when the calculations were performed. If the data on the Soldiers is incomplete or in error, field managers use the EDAS promotion point update and promotion update functions to update the data, promote the Soldier, or alert HRC managers as to why Soldiers will not be promoted. EDAS returns the promotion on the Soldier to eMILPO which then updates local databases and the Defense Finance and Accounting Service (DFAS).

(7) EDAS fully supports mobilization scenarios. The policy subsystem can store and maintain any number of scenarios (peace, limited mobilization, full mobilization, etc.) and the user can invoke any one of the scenarios in seconds. The system can also evaluate "what if" questions.

i. The Army Automated RETAIN. RETAIN is a real-time automated system that identifies and reserves training spaces or assignment vacancies for potential reenlistees and determines MOS availability for Soldiers undergoing reclassification based upon the individual's qualifications and the needs of the Army. It is also used to process enlisted Soldiers for reenlistment or reclassification assignments.

(1) If the Soldier is requesting a MOS training space, RETAIN accesses the REQUEST system to determine if there are any AC in-service quotas available for the school the Soldier desires. If the seat is available, it allows the retention NCO or reclassification authority to make a reservation and puts the record on the RETAIN wait list for an ultimate assignment in the new MOS upon completion of training. The wait list manager is required to give the Soldier an ultimate assignment 120 days prior to the start date of the school. RETAIN is also used to process potential reenlistees for assignments. RETAIN will determine if there are any vacancies available for the installation/overseas area the Soldier desires. If a vacancy exists, it will be offered to the Soldier. If a vacancy does not exist, the Soldier may elect to be put on the RETAIN wait list.

(2) The RETAIN wait list is for those Soldiers desiring an installation/overseas area which was not available and no other area/location was available at the time of entry into RETAIN. Weekly, the RETAIN system attempts to match Soldiers on the wait list to the place they desire to go.

(3) RETAIN is a valuable tool that commanders, career counselors, and personnel service centers use in counseling Soldiers for reenlistment and reclassification. Since RETAIN is a real-time automated system it can provide current, accurate information to the potential reenlistee or Soldier involved in reclassification.

j. Reclassification. RETAIN also addresses reclassification. Reclassification is a process which provides for migration from one MOS to another. It supports policies and goals to reduce MOS overstrength and alleviate shortages. In addition to individual voluntary requests, mandatory reclassifications are necessary when a Soldier loses qualification, for example, loss of security clearance, or disqualifying medical condition. Special reclassification programs, such as Fast Track, realign MOS

overages through reenlistment and reclassification. Soldiers possessing the overstrength MOS may be allowed to reclassify or reenlist for retraining without regard to Expiration of Term of Service (ETS).

### 12-18. Officer Distribution and Assignment

The Army continues to adapt and change its officer assets by branch, functional area, and grade equal the sum total found in authorization documents, taking into consideration Professional Military Education (PME) schools and training programs for each branch and functional area. In fact, force structure change and growth due to modularity is by far outpacing the Army's ability to meet authorizations in certain skills and grades.

a. Distribution Planning. The officer distribution (see Fig 12-5) planners and managers at HRC are influenced by three principal factors: officer assets (inventory), authorizations, and priorities. All three are in a constant state of change. Therefore, there is a need for a master distribution plan that will ensure that all commands, agencies, and activities receive, according to priority, an appropriate share of the available officer assets/inventory. The foundation of this master plan is a management tool known as the Dynamic Distribution System (DDS), formerly the Officer Distribution Plan (ODP), and also formerly the Officer Distribution System (ODS). The DDS brings assets/inventory, authorizations, and priorities into balance and is one of the Army's most important systems for officer distribution planning. DDS allows the Army to be more flexible during times of war and transformation, as DDS allows us to shift with the Army's changing priorities.

b. The DDS Process. If available officer assets match the requirements identified through the PMAD, by branch, functional area, and grade, officers would simply be assigned against authorizations. However, this is rarely the case. As with most resources, there is generally a greater demand than there is a supply, and officer shortages in certain units is a result. Some system of priorities is needed to help manage these shortages. After the available officer inventory has been compared with the authorizations in the PMAD, a computer system, Statistical Analysis Software (SAS) runs a program model to determine officer needs based on current Army Manning Guidance initiatives and any special distribution guidance as determined by HQDA (Figure 12-5). Under DDS, an available officer fits into one of two categories: non-discretionary or discretionary. An important concept to keep in mind is what defines an available officer. An available officer is defined differently for each type of unit. Generally speaking, a deploying brigade needs a non-dwell restricted, deployable, PME graduate that needs key development time. The opposite is true for the National Training Center which needs a Key Developmental (KD) complete officer with recent deployment experience. A non-discretionary move includes those moves that involve hard dates in an officer's career, e.g., a DEROS from an overseas assignment, a report date to a professional school, a graduation date from a school, a command selection, a Personnel Management System (PMS) selection, a joint tour completion, a sequential assignment report date, or a retirement date. These can generally be determined from data analysis from TOPMIS. A discretionary move includes those moves that are triggered by an assignment officer working to ensure an officer continues appropriate career development e.g., an officer needs a new skill set (Joint or Army Staff), an officer's skills are no longer applicable to the current assignment, or where an officer is pre-positioned for a career enhancing position (Command, Schools, etc.). Moves driven by the individual needs of the officer are also included in this category e.g. Exceptional Family Member Program (EFMP), joint domicile, and compassionate reassignments and personal preference.

## Officer Distribution

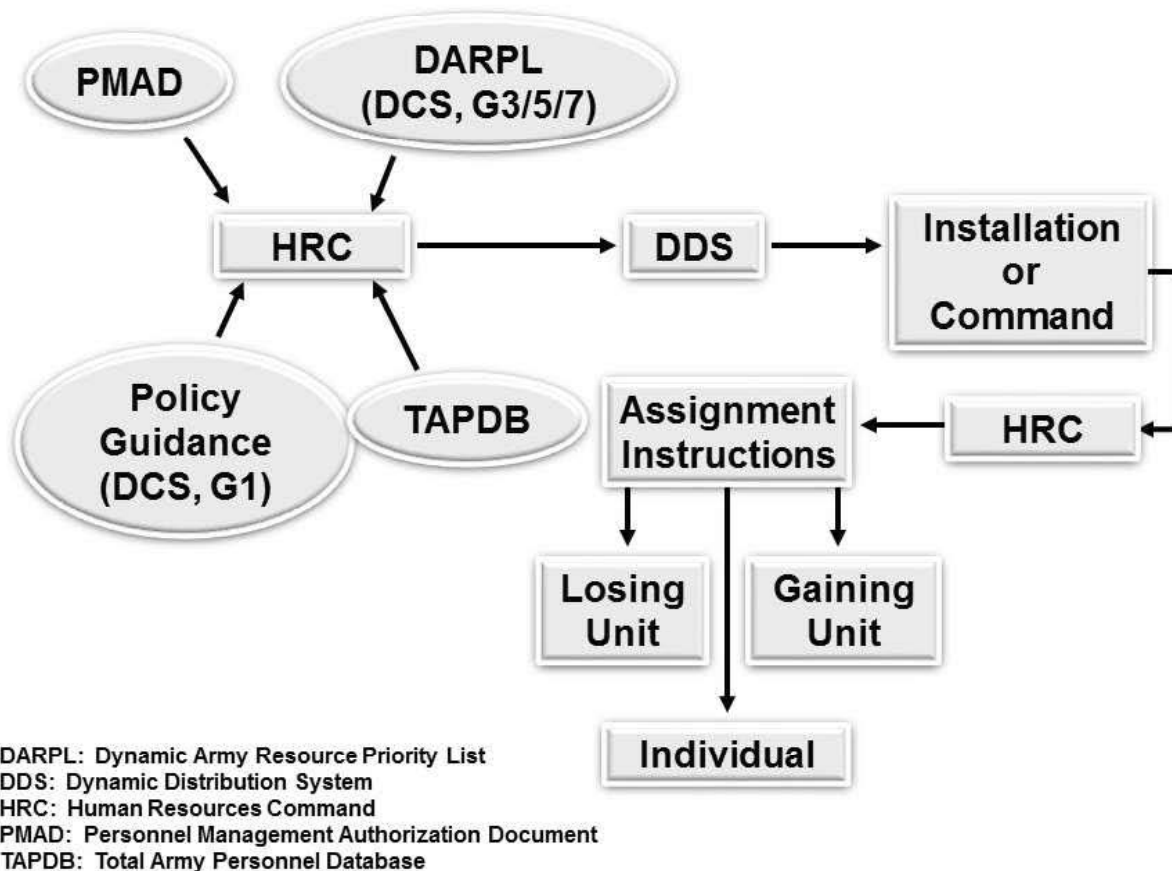

Figure 12-5. Officer Distribution

c. Officer Requisition System. The officer requisition system is designed to fill the officer requirements of all commands and activities.

(1) TOPMIS. This is a fully integrated management information system that supports the officer management process within HRC and at worldwide requisitioning activities. TOPMIS is composed of seven operational modules:

(a) The control module provides security of access and updating, creates individual user profiles, and provides on-line electronic mail service to all TOPMIS users.

(b) The strength module displays operating and projected strength down to the CMF level for requisitioning activities in various report formats.

(c) The goaling and monitoring module displays assignment goals for the FY by grade and CMF. It is also used to plan the DDS and monitor its progress.

(d) The requisition module allows distribution managers and the requisition activity managers to generate, edit, validate (based on the DDS), and update requisitions. This module generates and maintains requisitions based on projected strength. The final product is a list of requisitions for career managers to fill.

(e) The asset/Officer Record Brief (ORB) module provides an online version of the ORB and the capability for on-line updating of ORB fields by career managers. This module also provides access to by-name reports of officers assigned and/or on orders.

(f) The assignment module provides access to personnel, requisition, and organization data; provides online extract/update capability from the TAPDB-AO via TOPMIS; and processes assignments generated

by HRC managers in the Officer Personnel Management Directorate (OPMD). Assignment instructions are transmitted electronically on a daily basis to the gaining and losing requisition activity.

(g) The user assistance module allows users to review data name definitions and tables of valid codes used in officer management.

(h) TOPMIS interacts with the TAPDB-AO and is used by assignment and distribution managers of the basic branches, medical department branches, the Chief of Chaplains, and JAG offices. Worldwide requisition/officer management activities can access TOPMIS through the Defense Data Network (DDN) or a variety of host-to-host systems.

(2) Requisition Cycles. Officer requisitions are generated on an alternating bimonthly basis for either overseas or CONUS. As a general goal, requisitions are validated so that officers will arrive 12 months after validation, which also allows a 12-month notification to the officer concerned. As a normal rule, overseas returnees, school requirements and units preparing to deploy drive the assignment system because these officers must move on time and deploying units must have necessary officer assets. Overseas returnees and various school requirements are largely due to tour length policies and graduation dates respectively. Others are assigned to replace these personnel and the cycle continues.

(3) Assignment Challenge. Assignment officers within the divisions and branches of OPMD must take into consideration a wide variety of competing factors in the process of identifying the right officers to fill valid requisitions. Some, but by no means all, of these factors are listed below. They are in no particular order, because each assignment action is unique—

- (a) Army requirements.
- (b) Gaining and losing organizations' requirements.
- (c) Tour equity (CONUS vs OCONUS).
- (d) Time-on-station and Dwell time.
- (e) Professional development.
- (f) Officer preference.
- (g) Joint domicile.
- (h) Compassionate situations.
- (i) CTC experience.
- (j) Joint duty.

### Section VI The Development Function

#### 12-19. Enlisted Development

There must be a way of developing leadership, evaluating, and rewarding those who do well, and eliminating those who do not measure up. This section will address some of the programs designed to accomplish these tasks and to create an environment which will motivate men and women to become career Soldiers.

#### 12-20. Enlisted Personnel Management System

a. The EPMS provides a logical career path from private to sergeant major, career-long training, and performance-oriented evaluation. Additionally, it is designed to eliminate promotion bottlenecks, provide all Soldiers with promotion opportunities, make assignments more flexible, and provide greater challenge by making MOSs more multi-functional.

b. A key feature of EPMS is to associate five standardized skill levels for the enlisted ranks, with privates and specialists having skill level 1 and master sergeants and sergeants major having skill level 5. EPMS skill levels were selected so that the vital middle-grade NCOs would be distinct and visible for management purposes.

c. Another major feature of EPMS is the Noncommissioned Officer Professional Development System (NCOPDS). EPMS and NCOPDS are part of the same continuum.

#### 12-21. Enlisted Evaluation System

At the heart of EPMS is the EES. It is used to assist in the identification of Soldiers for assignment, promotion, reenlistment, reclassification, special training, elimination, and other personnel management actions. The EES consists of Academic Evaluation Reports (AER) and a NCO Evaluation Report

(NCOER) for sergeant and above. Both reports serve as the official evaluation of duty performance and academic success and provide a record of each individual NCO's potential.

### **12-22. The Noncommissioned Officer Leader Self-Development Career Model**

a. The NCO Leader Self-Development Career Model provides enlisted Soldiers a guide in the selection of self-development activities recommended by CMF proponents. Career models have been developed by subject matter experts (SME) for each CMF and are published in DA PAM 600-25.

b. The career models correspond to the Army's leader development process relating self-development activities to institutional training and operational assignments. The models can help Soldiers establish planned, progressive, and sequential self-development programs, which enhance and sustain military competencies as well as required Skills, Knowledge, and Attributes (SKA). The career models also contain CMF-proponent recommended goals, e.g., licensure, certification, or academic degree, and allow Soldiers to combine experience and training with self-development activities for career progression as well as goal achievement.

c. Activities and goals are recommendations, not requirements, and do not preclude mission assignments and training. Completion does not guarantee advancement. The career models are tools for use by supervisors and professional education counselors to help guide Soldiers in their professional and personal growth. They also may be used to help Soldiers prepare for NCOPDS and NCO functional resident courses.

d. The elements in the leader development process—education, training, experience, assessment, feedback, and reinforcement—create a dynamic synergy to prepare Soldiers for increasing responsibilities. Self-development is the only aspect of that process over which the Soldier has direct control. The career model can stimulate involvement in this vital imperative, which should be the goal of every career Soldier. To foster this desire requires close cooperation between commanders, supervisors, education counselors, and the Soldier.

### **12-23. Enlisted Promotions**

a. The objectives of the enlisted promotion system are to ensure advancement of the best qualified Soldiers, to provide career incentive, to promote Soldiers based on potential rather than as a reward for past service, and to identify and preclude promotion of Soldiers who are nonproductive and ineffective. Three programs make up the promotion system: the decentralized program which controls advancements from private through specialist; the semi-centralized program which controls promotions to SGT and Staff Sergeant (SSG); and the centralized program which controls promotions to Sergeant First Class (SFC) through Sergeant Major (SGM)/Command Sergeant Major (CSM).

b. Under the decentralized program, authority to appoint and promote Soldiers is delegated to local commanders, but there must be compliance with standard policies and procedures established by HQDA. Promotion boards are not required.

c. Authority to promote Soldiers under the semi-centralized program is delegated to field commanders who are serving in an authorized lieutenant colonel or above command position in accordance with guidance from HQDA. In this case, eligible Soldiers compete Army-wide on the basis of relative standings by points attained on a standardized point system. Soldiers recommended for promotion are required to appear in person for evaluation by a selection board. Names of Soldiers recommended for promotion by the board are placed on a locally maintained recommended list and grouped by MOS in an order of merit based on the total points attained under the point system. HQDA controls the number of Soldiers who can be promoted in each MOS by establishing cut-off scores according to the needs of the Army. Soldiers whose scores equal or exceed the announced cut-off scores are promoted without regard to assignment. Those not immediately promoted remain on the recommended list until promoted, unless they are removed for administrative reasons or for cause. Soldiers on a recommended list may request reevaluation to improve their standing.

d. Promotions to sergeant first class through sergeant major are centralized and a board, convened by HQDA, makes selections. Selections are based on the whole person concept. No one single factor should be considered disqualifying but rather an individual's entire record is given careful consideration. Selections are made on a best-qualified basis in conjunction with Army needs.

### 12-24. Command Sergeants Major Program

This program ensures the selection and assignment of the best-qualified sergeants major, first sergeants, and master sergeants for command sergeant major positions. These positions are the principal enlisted assistants to commanders of organizations with enlisted troop strength equivalent to a battalion or higher level and commanded by a lieutenant colonel or above. Boards convened by HQDA make selections. A list of those selected is published and maintained within HRC for use in appointing personnel to fill vacancies. Command sergeants major are assigned only to positions that have been designated by the DCS, G-1.

### 12-25. Total Army Retention Program

This program consists of the AA Retention and RC Transition Programs and is responsible for assisting in manning the force with quality Soldiers by achieving and maintaining a balanced career content in the regular Army enlisted force. The retention program also focuses on improving quality through the retention of trained, qualified, and experienced enlisted Soldiers in the correct MOS and grade. Those not retained in the Active Force, being otherwise qualified, are recruited to serve in USAR or ARNG units. AC retention and RC transition program objectives are assigned to commands by DCS, G-1 while HRC provides overall program and personnel management of the programs. Personnel and fiscal support of the RC Transition Program is provided by the ARNG and USAR.

### 12-26. Qualitative Management Program

a. This program was developed as a means of enhancing the quality of the career enlisted force, selectively retaining the best qualified Soldiers and denying continued service to nonproductive Soldiers.

b. NCOs whose performance, conduct, and/or potential for advancement do not meet Army standards, as determined by the approved recommendations of HQDA centralized selection boards responsible for QMP screening, will be denied continued service. NCOs who are not promoted to the next grade because of their failure to complete the next appropriate level of the NCO Professional Development System (NCOPDS) training are subject to denial of continued service through the QMP. The QMP is not intended as a substitute, and does not relieve commanders of the responsibility for initiation of separation proceedings under other provisions of AR 635-200 when required or appropriate. Regularly scheduled, centralized promotion/selection boards for staff sergeant through command sergeant major selects individuals for promotion or retention in grade, as well as those Soldiers to be barred. These boards consider the Soldier's entire record using the whole person concept, not just his or her current job or term of service. Soldiers separated with a DA bar receive a reenlistment eligibility code of 3 (individual is not qualified for continued Army service, but the disqualification is waivable. Ineligible for enlistment unless a waiver is granted.). Effective 1 October 2016 the bar to reenlistment was redesignated as the bar to continued service. A bar to continued service places a Soldier on notice that his or her continued service may not be in the Army's best interest. Applicable to all enlisted ranks regardless of the established Retention Control Point (RCP)/maximum Time in Service (TIS) for each rank, a bar to continued service limits continued service to Soldiers of high moral character and personal competence. Accordingly, Soldiers who currently serve under the NCO Career Status Program, including Soldiers transitioning from the RA to a reserve component, may be barred from continued service. Reenlistment is deemed a privilege and not a right. It is the responsibility of commanders, at all levels, to ensure that only those Soldiers of high moral character, personal competence, and demonstrated performance are allowed to reenlist in the Army. Reenlistment should be denied to Soldiers who by their performance, conduct, and potential indicate further service will be non-progressive and unproductive.

c. Under the Army Mobilization Operation Plan, Annex E, Personnel, the QMP can be suspended for the period the Army is under partial mobilization.

### 12-27. Warrant Officer Development

a. The implementation of TWOS in 1986, the Warrant Officer Management Act (WOMA) of 1991, the Warrant Officer Leader Development Action Plan (WOLDAP) in 1992, the Warrant Officer Education System (WOES) in 1993, and the Army Training and Leader Development Panel (ATLDP) decisions in 2002, have had a major impact on the management and professional development of warrant officers. The Army's current goal is to recruit warrant officers earlier in their careers, train them better, and retain them longer. About half of all warrant officers retire after 23 years of combined (enlisted and warrant officer) active federal service. Under WOMA, decisions on promotions, training, and assignments are



based on years of Warrant Officer Service (WOS). A careerist will have an opportunity to serve up to 30 years of WOS unless twice nonselected for promotion to the next higher grade.

b. Every Active Army warrant officer position in authorization documents is classified by rank based on the skills, knowledge, abilities, and experience needed in that position. Formerly there was no rank differentiation in warrant officer positions.

### **12-28. Warrant Officer Management Act**

a. WOMA provided a comprehensive and uniform personnel management system, similar to Defense Officer Personnel Management Act (DOPMA), for warrant officer appointments, promotions, separations, and retirements. The key provisions of WOMA include the following.

(1) Authorized the grade of CW5, to include pay and allowances. Maximum number of CW5s on active duty is limited to 5% of the total number of warrant officers on active duty.

(2) Eliminated the dual promotion system and established a DOPMA-style promotion system for warrant officers.

(3) Established minimum Time in Grade (TIG) requirement for consideration for promotion.

(4) Established authority to convene Selective Retirement Boards (SRB) to consider retirement eligible warrant officers for involuntary retirement.

(5) Established the management of warrant officers by years of WOS rather than by Active Federal Service (AFS). A warrant officer may serve for 30 years of WOS. Retirement eligibility at 20 years AFS remains unchanged.

(6) Established selective continuation for warrant officers twice nonselected for promotion (very limited use and normally in shortage skills).

(7) Modified the involuntary separation date from 60 days to the first day of the seventh month after board results are approved. This provision applies to warrant officers twice nonselected for promotion and those selected for involuntary retirement.

b. WOMA modernized the warrant officer life cycle management, offers all warrant officers the potential for a full career, provides tools to shape the force, and enhances readiness by providing the Army with a highly qualified and experienced WO cohort.

### **12-29. Warrant Officer Education System**

Warrant officer education is integrated within the Officer Education System (OES). Warrant officer specific courses are depicted in Figure 12-6. Chapter 14 provides additional information on these courses and other warrant officer training and education.

a. The WOBC is the first course encountered by all newly appointed WO1s. WOBC certifies the new WO1 within his branch and specialty.

b. The Warrant Officer Advanced Course (WOAC) is a combination of common core and MOS proponent training that prepares warrant officers to serve in CW3 level positions. WOAC is provided in a non-resident common core phase and a resident phase, which includes a common core module and a MOS-specific module. Completion of the Action Officer Development Course (AODC) is a prerequisite for WOAC attendance

c. The Warrant Officer Intermediate Level Education (WOILE) provides senior CW3s and new CW4s with the intermediate-level education and influential leadership skills necessary to apply their technical expertise in support of leaders on tactical and operational level Joint, Interagency, Intergovernmental, and Multinational (JIIM) staffs during unified land operations.

d. The Warrant Officer Senior Service Education (WOSSE) is the capstone for WO PME conducted at the Warrant Officer Career Center (WOCC), Fort Rucker, Alabama. WOCC provides senior CW4s and new CW5s with the senior level education, knowledge, and influential leadership skills necessary to apply their technical expertise in support of leaders on strategic level JIIM staffs during unified land operations.

e. The WOCC serves as the Training and Doctrine Command (TRADOC) executive agent for warrant officer common core education. The WOCC evaluates common core instruction within the proponent specific program of instruction for WOBC and WOAC.

## Warrant Officer Training and Education

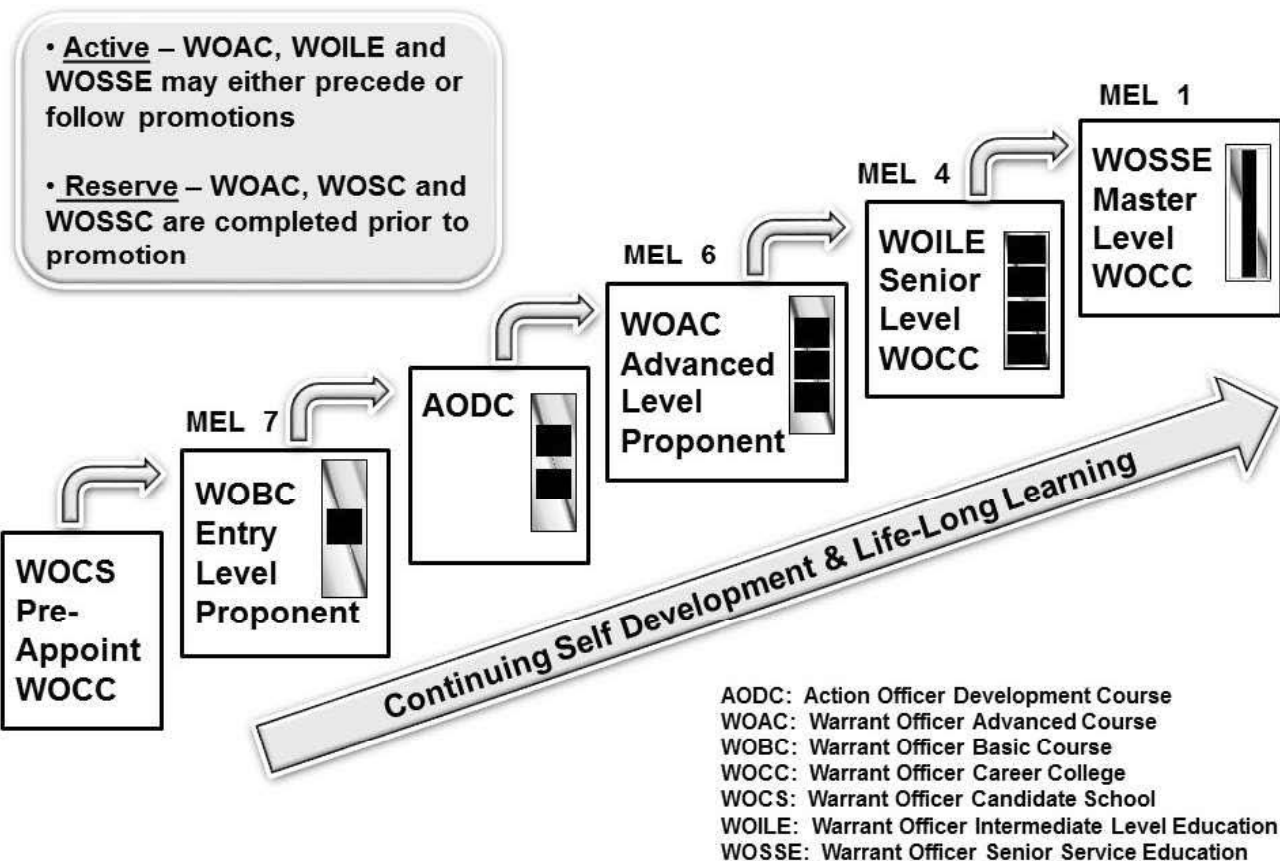

**Figure 12-6. Warrant Officer Training and Education**

### 12-30. Warrant Officer Promotions

Warrant officers are promoted under a single permanent promotion system similar to the commissioned officer system.

a. Promotions to CW3, CW4, and CW5 for warrant officers on the Active Duty List (ADL) are administered at HQDA. Promotion authority to CW2 is delegated to commanders in the rank of lieutenant colonel and above. Warrant officers may be promoted to CW2 after completion of 24 months in the grade of WO1 under current policy. WOMA allows CW2 promotion consideration after 18 months in grade. Time in grade for promotions to CW3, CW4, and CW5 are depicted in Figure 12-7 and Table 12-1, but vary with Army requirements.

b. Warrant officers twice nonselected for promotion to the next higher grade will be discharged or retired, if eligible, unless selectively continued on active duty to meet a valid Army requirement.

**Table 12-1. Warrant Officer Promotion Goals**

To grade	Promotion opportunity	Years AWOS
W2	Fully qualified	2
W3	80%	7-8
W4	74%	12-14
W5 <sup>1</sup>	44%	17-20

Note: 1. By law the number of CW5s is limited to 5% of the warrant officer force.

## Warrant Officer Promotion Timeline

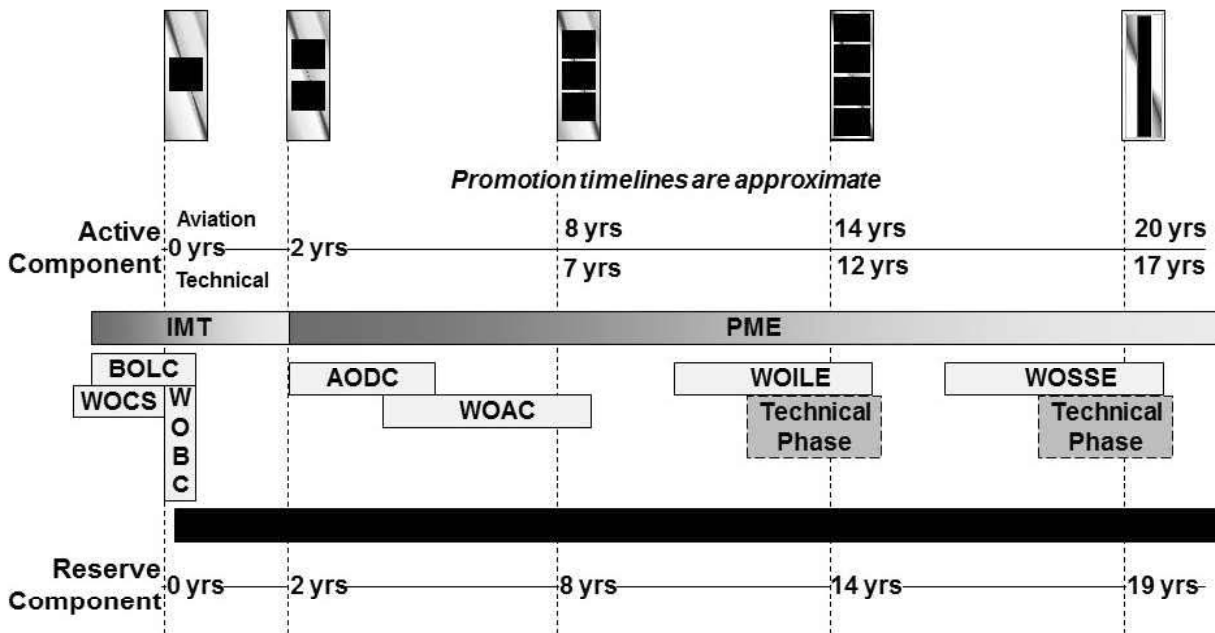

AODC: Action Officer Development Course  
 BOLC: Basic Officer Leadership Course  
 WOAC: Warrant Officer Advanced Course  
 WOBC: Warrant Officer Basic Course  
 WOCS: Warrant Officer Candidate School  
 WOILE: Warrant Officer Intermediate Level Education  
 WOSSE: Warrant Officer Senior Service Education

**Figure 12-7. Warrant Officer Promotion Timeline**

### 12-31. Warrant Officer Retention Programs

- Regular Army integration and commissioning is concurrent with promotion to CW2. Officers who decline regular Army integration will not be promoted and shall be separated 90 days after the declination date or upon completion of any active duty service obligation, whichever is later.
- Separate regular Army integration boards were discontinued during the Army drawdown. Future boards are planned to only consider exceptions; for example, a USAR CW3 who requests and is called to active duty to fill a valid requirement.
- Warrant officers are released from active duty after being twice non-selected for promotion to the next higher grade unless they are selectively continued.

### 12-32. Officer Development

The OPMS provides a framework for developing the required number of officers with the necessary skills and for managing the careers of all commissioned officers, except those assigned to the special branches (Army Medical Department (AMEDD), JAG, and Chaplain Corps). This framework consists of all OPMS functional categories, with each one being a grouping of duty positions whose skill, knowledge, and job requirements are mutually supportive in the development of officers to successfully perform in the functional category. Each functional category contains sufficient duty positions to support progression to the grade of colonel. Military and civilian educational opportunities are also geared to the officer's functional category. Army requirements and an individual's qualifications and preference are the major considerations in determining the designation of functional categories. OPMS consists of three major and interrelated subsystems: strength management, professional development, and evaluation.

### 12-33. Officer Professional Management System

In May 1997, the CSA approved implementation of several changes in OPMS as a result of the recommendations of the OPMS XXI Task Force. During 2002, the DCS, G-1 changed the name to OPMS III (vice OPMS XXI) to reflect the system as progressive and evolving to support emerging needs for the 21<sup>st</sup> century. In 2006 the DCS, G1 eliminated the numerical designation in recognition that OPMS was designed to be a continual evolution.

#### a. Historical Perspective.

(1) OPMS exists to balance the needs of the Army with the aspirations and developmental requirements of the officer corps. OPMS was instituted in 1972 as a result of the U.S. Army War College Study on Military Professionalism and a follow-on analysis directed by the DCS, G-1. After passage of the DOPMA by Congress in 1981, the CSA ordered a major review to examine the impact of the legislation on OPMS policies. As a result, OPMS II was developed in 1984 to accommodate the changes brought about by DOPMA, including the creation of functional areas, dual tracking and regular Army integration. In 1987, the CSA directed a review of officer leader development to account for the changes in law, policy, and procedures that had occurred since the creation of OPMS II. As a result of the study, the leader development action plan was approved for implementation in 1989.

(2) During the last decade plus, the Army has undergone significant changes with widespread affect on the officer personnel system, brought about by the drawdown at the end of the Cold War and by major legislative initiatives. The DOD Reorganization Act of 1986 (Goldwater-Nichols) required the Services to improve interoperability and provided the statutory requirements for joint duty assignments, joint tour credit and joint military education. In 1986, Congress also passed Public Law 99-145, which specified the acquisition experiences and education necessary for an officer to be the project manager of a major weapons system. This law later led to the creation in 1990 of the Army Acquisition Corps (AAC). The Defense Acquisition Workforce Improvement Act (DAWIA) of 1990 placed additional requirements on Acquisition Corps officers and directed them to single track in their functional area. Congressional Title VII (1992) and XI (1993) legislation placed additional officer requirements on the AA in their support of the RC. The Reserve Officer Personnel Management Act (ROPMA) of 1996 brought the RC officer promotion systems in synchronization with the AC. This legislation established a best-qualified promotion system for RC officers, thereby replacing the fully qualified system previously used.

#### b. Initiation of OPMS III.

(1) In 1994, a team of senior field grade officers was assembled to examine a series of OPMS-specific issues and to determine whether a general review of the OPMS was warranted. This OPMS XXI Precursor Study Group ultimately reviewed more than 60 individual issues. Based on the collective body of these issues, the OPMS XXI Task Force convened in July 1996 to review and revise the personnel management system as necessary to ensure its viability for meeting future challenges. The Task Force focused on the development and career management of officers of the Army Competitive Category (ACC). The special branches (Chaplain, JAG, and the branches of the AMEDD) were not specifically addressed although some OPMS XXI issues and solutions dealing with education, officer evaluation, and general promotion policies applied to them as well.

(2) The Task Force linked its work with other ongoing Army planning efforts: Force XXI for the near-term, Army XXI initiatives for the mid-term, and Army after next projections for the long-term planning environment. In designing the personnel system for the future, the CSA directed the task force to also create a conceptual framework that integrated OPMS with the leader development system, ongoing character development initiatives and the then new officer evaluation report.

(3) The task force concluded that, in order for OPMS III to work effectively, three sets of strategic recommendations for change must be jointly addressed.

(a) The first recommendation called for the creation of an Officer Development System (ODS) as part of an overall Army development system. ODS will encompass and integrate officer leader development, character development, evaluation, and personnel management.

(b) The second recommendation recognized the need to adopt a holistic, Strategic Human Resource Management (SHRM) approach to officer development and personnel management for the 21<sup>st</sup> Century.

(c) The final strategic recommendation by the task force called for the creation of an officer career field-based management system composed of four career fields: Operations, Operational Support, Institutional Support, and Information Operations. Under OPMS III, officers are designated into a single career field after selection for major and serve and compete for promotion in their designated career field from that point on.

(d) The results of these strategic recommendations, approved by the CSA in December 1997, formed the basis for the changes to OPMS until 2005.

(e) In 2005 the CSA directed that OPMS be reviewed to determine if the system met the developmental needs of the officer corps for the future. After study by a new OPMS task force, and a vetting process for recommendations with subject matter experts, a Council of Colonels representing all stakeholders, and General Officer Steering Committees, many changes have been approved or are under consideration at this writing. Driving many of the changes is the Army leadership's view that the future officer corps needs to be more multi-skilled and afforded assignment and educational opportunities that foster this end. Among the changes approved was changing the four career fields to three functional categories as depicted in Figure 12-8. The new design is considered more conducive to bringing balance to the officer corps—breadth and depth, was less prescriptive, and provided multiple career paths. There have been some changes to this initial construct as functional areas were eliminated or consolidated (e.g. Comptroller, HR) and other created (e.g., Logistics Corps).

## Functionally Aligned OPMS Design

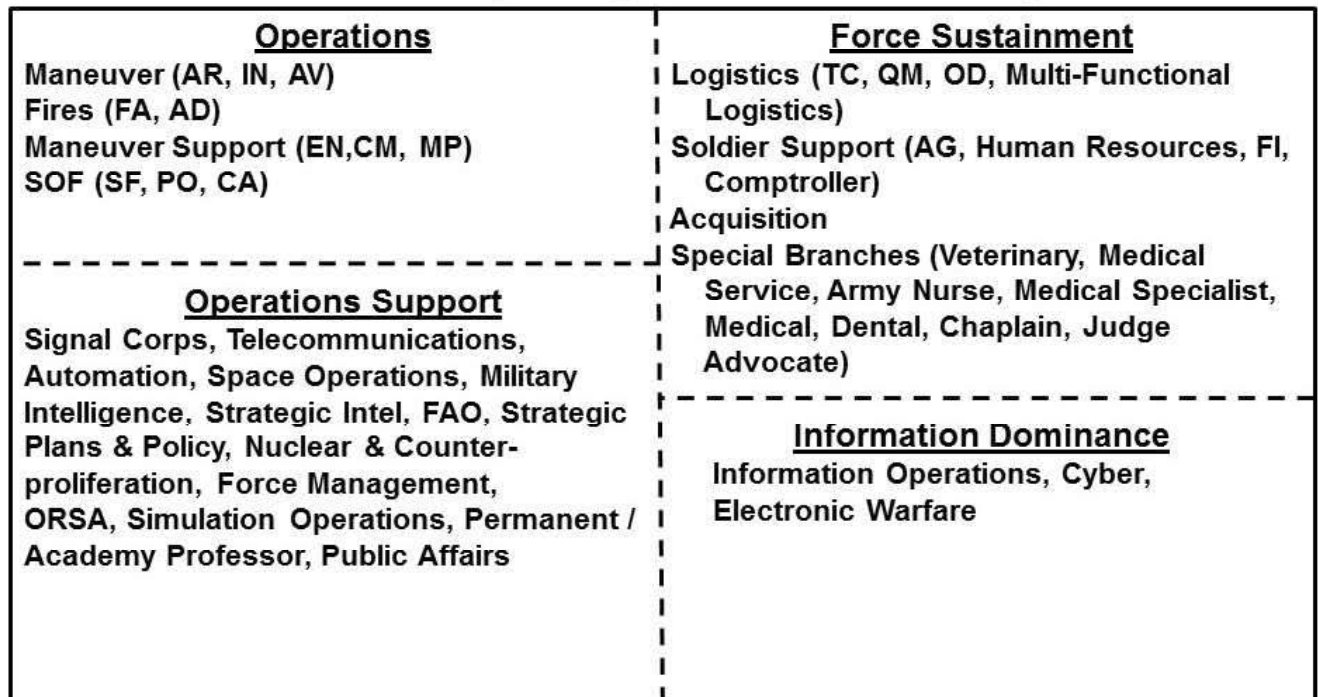

- |                      |   |  |                              |
|----------------------|---|--|------------------------------|
| AD: Air Defense      | EN: Engineers                                     | MP: Military Police                          | PAO: Public Affairs          |
| AG: Adjutant General | EW: Electronic Warfare                            | MI: Military Intelligence                    | PO: Psychological Operations |
| AN: Army Nurse       | FA: Field Artillery                               | MC: Medical                                  | QM: Quartermaster            |
| AR: Armor            | FAO: Foreign Area Officer                         | MS: Medical Service                          | SC: Signal                   |
| AV: Aviation         | FI: Finance                                       | OD: Ordnance                                 | SF: Special Forces           |
| CA: Civil Affairs    | IN: Infantry                                      | OPMS: Officer Professional Management System | SP: Medical Specialist       |
| CH: Chaplain         | IO: Information Operations                        | ORSA: Operations Research/Systems Analysis   | TC: Transportation           |
| CM: Chemical         | ISR: Intelligence Surveillance and Reconnaissance |  | VC: Veterinary               |
| CY: Cyber            | JA: Judge Advocate                                |  |                              |
| DC: Dental           |   |  |                              |

**Figure 12-8. Functionally Aligned Officer Personnel Management System Design**

### 12-34. Fundamentals of Officer Management

The Army needs, and will continue to need, the finest officers imbued with the warfighting ethos and with the right skills, knowledge and experience to effectively meet any challenges. Further, the Army continues to be a values-based organization, steeped in core principles and beliefs that set the muddy boots Soldier apart as a unique professional. In order to grow an Officer Corps with the right SKA to

respond to evolving future challenges—to remain ready not only today but also tomorrow—OPMS changed many aspects of how officers are managed, developed, and promoted.

a. **Functional Category Based Management.** Officers are developed in only one branch, and the branch remains primary for approximately the first 6-8 years of an officer's career (an exception exists for those officers being branch detailed as a new lieutenant and a small number of officers in selected functional areas). Functional category designation begins after the fourth year of service. Officer preference is a key factor in terms of board selection criteria in the functional category designation process, but Army requirements are always paramount.

b. **Functional Areas.** Functional areas are not directly related to any specific branch. Incorporating what are referred to as non-accession specialties, functional areas provide a management and development system to effectively use the vast talents of a diverse officer corps and meet Army requirements.

### **12-35. Functional Categories**

Officers compete for promotion only with other officers in the same functional category. Each functional category, or branch or functional area within a functional category, has its own unique characteristics and development track for officers that reflects the readiness requirements of the Army today and into the 21st century. DA PAM 600-3 outlines all aspects of OPMS, officer training, education and development. Officers from every branch and functional area will also fill officer generalist and combat arms generalist (01A/02A) positions across the Army. Functional categories are depicted in Figure 12-8.

### **12-36. Functional Category Assignment**

The functional designation process determines in which specialty officers will continue their development; either in their accession branch or in a different FA. Management of officer development in functional categories recognizes the need to balance specialization of the officer corps with the inherent requirement for officers to gain more breadth in an increasingly complex environment. Officers have periodic opportunities after the 4th year of officer service to transfer to a different branch or FA. The process is known as the Voluntary Transfer Incentive Program (VTIP) and is managed by HRC to balance inventories with Army requirements and to leverage individual officer preferences and demonstrated abilities. VTIP panels are conducted two to three times a year and are announced via military personnel (MILPER) message describing procedures and specialties to be considered for cross leveling. VTIP allows HRC to identify and target officers with critical skills early in their development, allowing them to get additional training and experience to bring those skills to bear as quickly as possible. The VTIP balances the force across the four functional categories. The intent of the VTIP panel is to fill requirements and provide the FAs enough time to send their officers to school and training prior to utilization. The VTIP process ensures that the needs of the Army are met for future field grade officer requirements in each functional category. Each functional category has its own unique characteristics and development model for officers, which reflects the readiness requirements of the Army today and into the 21st century. Officers in all functional categories are assigned across the Army in TOE and TDA organizations.

### **12-37. Centralized Selection for Command and Key Billet Positions**

The Centralized Selection List (CSL) emphasizes the preference-based approach to an officer's career pattern. The CSL includes four functional categories of commands and key billets as depicted in Figure 12-9. The CSL commands include all Lieutenant Colonel (LTC) and Colonel (COL) command positions approved by the Army. The list of centrally selected command positions changes regularly. In FY 2004 key division staff positions (G1, G2, and G6) were added to the list of centrally selected positions. Prior to convening each command selection board, officers being considered will be given the opportunity to indicate the functional category (or categories) in which they desire to compete for selection. The board selects officers for command within the given categories and HRC conducts the slating process and recommends the specific unit or organization for the officer to command. The CSA has the final decision on the command slate.

## Centralized Selection List (CSL) Categories

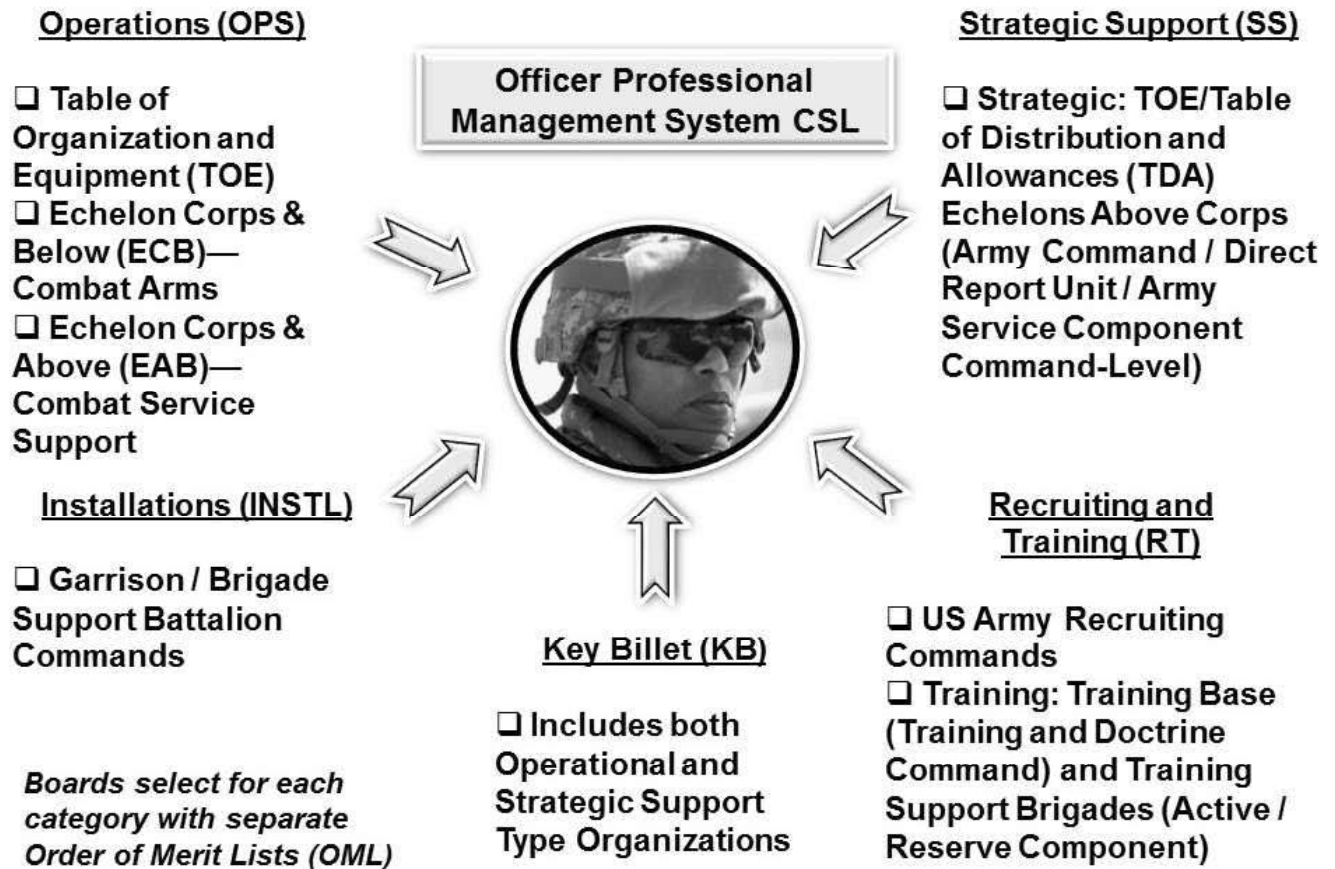

Figure 12-9. Centralized Selection List Categories

### 12-38. Officer Evaluation System

a. The Officer Evaluation System is the Army's method of identifying those officers most qualified for advancement and assignment to positions of increased responsibility. The system includes assessments of officer performance and potential accomplished in the organizational duty environment; in an academic environment, both military and civilian; and at joint and departmental levels.

b. The potential assessment of an officer is a subjective judgment as to the officer's capability to perform at a specified level of responsibility, authority, or sensitivity. Although potential is normally associated with the capability to perform at a higher grade, judgments are also made by DA on retention and increased responsibility within a specified grade. The assessment is based on three major factors: the Army's officer requirements, the individual officer's qualifications, and a summation of the individual officer's performance.

c. The performance assessment by DA differs significantly from that accomplished in the organizational duty environment. Whereas the organizational duty assessment involves a personal knowledge of the situations surrounding a specific period of time, DA assessment is accomplished by an after-the-fact assessment of a series of reports on performance over a variety of duty positions and covering the officer's entire career.

### 12-39. Officer Evaluation Report System

a. The OER System is a subsystem of the Officer Evaluation System. It includes the methods and procedures for organizational evaluation and assessment of an officer's performance and an estimation of

potential for future service based on the manner of that performance. The official documentation of these assessments is the OER and the AER.

b. The primary function of the OER System is to provide information from the organizational chain to be used by DA for officer personnel decisions. The information contained in the OER is correlated with the Army's needs and individual officer qualifications providing the basis for personnel actions such as promotion, elimination, retention in grade, retention on active duty, reduction in force, command designation, school selection, assignment, and functional category designation.

c. A secondary function of the OER System is to encourage the professional development of the officer corps. To enhance this, emphasis is placed on the responsibility of senior officers to counsel their subordinates. While this has always been a major aspect of leadership, continual reemphasis is necessary. The OER System contributes significantly by providing a natural impetus to continual two-way communication between senior and subordinate. It is through this communication that the rated officer is made aware of the specific nature of his or her duties and is provided an opportunity to participate in the process. The rater uses the communication to give direction to and develop his or her subordinates, to obtain information as to the status and progress of his or her organization, and to plan systematically for the accomplishment of the mission. The senior/ subordinate communication process also facilitates the dissemination of career development information, advice, and guidance to the rated officer. This enables the rated officer to take advantage of the superior's experience when making functional category or assignment-related decisions.

**12-40. Officer Promotions**

As of 15 September 1981, the DOPMA amended Title 10 for officer promotions. DOPMA, as implemented, is applicable to all officers on the ADL. It does not apply to warrant officers. The act provides for a single promotion system for all officers (regular Army and Other than Regular Army (OTRA)), thus eliminating the previous dual (Army of the United States (AUS)/RA or AUS/USAR) system of promotions. The intent is for promotions to be made within fairly uniform promotion timing and opportunity goals, as vacancies occur. Eligibility for consideration for promotions is based on minimum TIG and Time in Service (TIS) with the below-the-zone selection rate established at a maximum of 10% (or 15% when so authorized by the Secretary of Defense (SECDEF)) of the list for any grade above captain. Goals for promotion opportunity and phase point (i.e., TIS when most officers are promoted) are listed in Table 12-2, as found in DOD Instruction (DODI) 1320.13 dated 30 October 2014 (Actual promotion percentages and TIG/TIS may vary considerably).

**Table 12-2. Career Progression Pattern**

To grade	Promotion opportunity	DOPMA phase point
First Lieutenant	Fully Qualified	18 MOS TIS/TIG min
Captain	90%	Not less than 2 years TIG
Major	80%	10 +/-1 year
Lieutenant Colonel	70%	16 +/-1 year
Colonel	50%	22 +/-1 year

Note: Opportunity and TIS are set by policy. TIG for promotion to 1LT and CPT is set by law.

**12-41. Officer Quality Management**

a. The goal of the officer management program is to ensure that only those individuals demonstrating satisfactory performance and possessing acceptable moral and professional traits be allowed to serve on active duty, retain their commissions, and remain on DA promotion lists.

b. Commanders and DA agencies are continually striving to maintain the quality of the officer corps by identifying and processing for involuntary separation those officers whose performance or professional or moral traits are deficient. To this end, the records of officers are screened continually to identify those whose degree of efficiency and manner of performance and/or misconduct, moral, or professional dereliction require separation.

c. Whenever an officer is identified to show cause, the officer is afforded the opportunity to resign in lieu of undergoing the entire process. Similarly, DA agencies are tasked to review promotion lists and CSLs to ensure that no officer is promoted or allowed to command who has become mentally, physically, morally, or professionally disqualified after being selected. The records of officers whose fitness for



promotion or command has become suspect are referred to a DA Promotion/Command Review Board, which will recommend to the SECARMY whether the officer should be retained on or removed from the promotion/CSL.

d. The promotion system also serves as a qualitative management tool through the mandatory separation from active duty of officers who fail to be selected for promotion to certain grade levels. However, an officer non-selected for promotion may be selectively continued in his current rank upon recommendation by the DA promotion board that non-selected him for promotion.

e. No person has an inherent right to continue service as an officer. The privilege of service is his or hers only as long as he or she performs in a satisfactory manner. Responsibility for leadership and example requires officers accomplish their duties effectively and conduct themselves in an exemplary manner at all times.

#### **12-42. Officer Strength Management**

When manpower reductions are necessary, the Army has several programs that may be applied to reduce the number of officers on active duty. When possible, reductions are accomplished through normal attrition and voluntary release programs coupled with reduced officer accessions. In the past, Congress directed the Services to include senior as well as junior officers when implementing officer strength cuts, Selective Early Retirement Boards (SERB) and Reductions-in-Force (RIF) may be implemented when required. RIFs target all officers by year while SERBs select a fixed number of retirement-eligible officers for involuntary early retirement. RIFs and SERBs are quantitative measures that are qualitatively administered.

#### **12-43. Defense Officer Personnel Management Act**

DOPMA evolved from the continued inability of the Officer Personnel Act (OPA) of 1947, as changed by the Officer Grade Limitation Act (OGLA) of 1954, to meet the changing requirements for a modern and equitable officer management system for the active forces. The intent of DOPMA was to provide all Services with an equitable, effective, and efficient system to manage their officer corps below the brigadier general level.

a. The management objective is to provide consistent career and promotion opportunities across all Services in order to attract and retain high-caliber officers, and promote them at a point in service conducive to effective performance. The integration into a single promotion and grade authorization system of the dual-track Regular Army/Reserve system mandated by OGLA and OPA provided a more favorable environment in which to achieve this goal.

b. The provisions for selective continuation of captains and majors, combined with the capability to instruct promotion boards on skill needs, provides a mechanism through which specialty needs can be filled, while enhancing an officer's opportunity to stay on active duty until retirement. Under DOPMA, a first lieutenant who twice fails to be selected for promotion to captain is involuntarily released from active duty. By law, captains and majors may be selectively continued to remain on active duty until 20 and 24 years respectively. DOPMA establishes uniform, general constructive provisions for all Services, thus recognizing that special skills acquired are essential for effective performance in special branches. This provision impacted AMEDD, Chaplain, and the JAG accessed after the effective date of the act.

#### **12-44. Department of Defense Reorganization Act of 1986 (Goldwater-Nichols)**

The congressional goal of this act was to improve the performance of officers in joint duty positions by establishing management procedures for their selection, education, assignment, and promotion. Key provisions of the law are listed below.

a. Assignments. The qualifications of officers assigned to joint duty assignments will be such that they are expected to meet certain specified promotion rates comparable to their Service headquarters and the overall board selection rate. Officers assigned to joint duty assignments will be assigned in anticipation that they will serve the prescribed tour length for their grade: two years for general officers and three years for others. Assignments for officers possessing critical occupational specialties, which for the Army are defined as the combat arms branches, may be curtailed to a minimum of 24 months under certain conditions. All graduates of professional joint education (e.g., National War College and Industrial College of the Armed Forces (ICAF)) who are designated as Joint Specialty Officers (JSO), and a high proportion (greater than 50%) of those graduates not designated as JSO, will be assigned to a joint duty assignment immediately following graduation.

b. Promotions. Selection boards considering officers serving in, or who have served in, joint duty assignments will include at least one officer designated by the Chairman of the Joint Chiefs of Staff (CJCS) who is currently serving in a joint duty assignment. The letter of instruction for selection boards includes the following guidance: “You will give appropriate consideration to the performance in joint duty assignments of officers who are serving in, or who have served in such assignments.” Prior to approval by the Secretary of the Military Department, the results of selection boards considering officers who are serving in, or who have served in, joint duty assignments will be forwarded by the Secretary to the CJCS. The CJCS will review the results to determine whether appropriate consideration was given to performance in joint duty assignments.

c. Reports. Each Secretary of a Military Department must provide periodic progress reports on their promotion rates in relation to the promotion objectives specified above.

d. General/flag officer actions. In the absence of a waiver (waiver authority was eliminated in the 2007 NDAA) by the SECDEF, officers selected to the grade of O-7 subsequent to 1 January 1994 must have completed a full joint duty assignment before selection or their first assignment as a general/flag officer will be in a joint duty assignment. A capstone military education course has been created and all newly promoted general/flag officers must attend this course within two years after selection, unless such attendance is waived by the SECDEF.

### **Section VII** **The Sustainment Function**

#### **12-45. Sustainment Function Overview**

The sustainment function includes a broad range of activities that are focused on the well-being of Soldiers, retirees, and their families. The range includes but is not limited to quality of life activities, awards, and decorations, casualty and memorial affairs, housing, morale, recreation, personnel actions, and Soldier readiness.

#### **12-46. Army Continuing Education System**

a. ACES is a critical element in the recruitment and retention of a quality force. ACES exist to ensure Soldiers have opportunities for personal and professional self-development. Education opportunities are offered through education centers, regional and state education offices, and learning centers located worldwide. Educational programs include the following.

- (1) On-duty functional academic skills training, which provides job-related instruction in the academic areas of reading, mathematics, and English grammar at no cost to the Soldier or adult family member.
- (2) High school completion programs for Soldiers without a high school diploma.
- (3) Undergraduate and graduate college courses and programs which provide financial assistance, such as the Tuition Assistance Program.
- (4) Foreign language programs for qualified Army linguists assigned overseas.
- (5) Skill development programs to prepare non-commissioned officers for NCOES training.
- (6) Counseling to establish challenging yet attainable short and long-term goals
- (7) Academic testing through the Defense Activity for Non-Traditional Education Support (DANTES).
- (8) Army personnel testing, and training support for skill specific and unit training, leaders' self-development and language and computer laboratories.

b. In addition, the Service members Opportunity College Army degree system of college and university networks promoting credit transferability and the Joint Service Transcript (JST) documenting recommended credit for Soldier training and experience help Soldiers earn degrees despite frequent transfers and rotations. The ACES, focused on Soldiers, family members, and available to DA civilians, represents a primary family covenant program.

c. To further enable Soldiers to continue their education, the Army has implemented a web-based portal, GoArmyEd.com, so that Soldiers and family members have anytime, anywhere access to education programs and services. Soldiers use GoArmyEd to request funding for college level courses wherever they are in the world. GoArmyEd.com provides Soldiers maximum flexibility to continue to pursue their individual educational goals.

**12-47. Equal Opportunity Program**

a. Army's Military Equal Opportunity (MEO) Program formulates, directs, and sustains a comprehensive effort to maximize human potential and to ensure fair treatment for all persons based solely on merit, fitness, and capability in support of readiness. This program strives to eliminate incidents of discrimination based on race, color, sex, religion, national origin, and sexual orientation and provide an environment free of unlawful discrimination or discriminatory behavior to include hazing and bullying. The Army Equal Opportunity Program is resonant in leadership that is rooted in taking care of Soldiers and is crucial to unit cohesion, readiness, and mission accomplishment. Ensuring Soldiers are treated with fairness, justice, and equity is central to an Army culture dedicated to the highest professional and personal standards and to sustaining our most important resource-people.

b. Commanders are assisted in sustaining MEO goals and objectives by an Equal Opportunity Program Manager (EOPM) at division level and above, Equal Opportunity Adviser (EOA) at brigade level and above, and an EO leader (EOL) collateral duty at battalion and company level. These MEO practitioners assist the commander in EO training, reporting and continuously assess the command climate to identify indicators of individual and institutional barriers. Soldiers volunteer or selected as EOPMs and EOAs receive 11 weeks of intensive training at Defense Equal Opportunity Management Institute (DEOMI), receive an ASI of "T" for officers and a SQI of "Q" for NCOs, and serve a 24 month tour as an EOPM or EOA. EOL receives 80 hours of training at the installation-level. The EO practitioner provides the commander a valuable subject matter resource for sustaining a positive EO climate, training, and developing remedies to eliminate practices or treatment, which affects readiness

**12-48. The Army Casualty System**

a. The casualty operations functions include casualty reporting, notification, assistance, and fatal accident family brief program. Casualty reporting is the source of information provided to the Next of Kin (NOK) concerning a casualty incident. It is of the utmost importance to provide that information accurately, promptly, and in as much detail as possible so that the NOK receive as full an accounting as possible of the casualty incident.

b. Defense Casualty Information Processing System (DCIPS) provides casualty, mortuary affairs, personal effects tracking and processing, remains tracking, Line of Duty (LOD) and Freedom of Information Act (FOIA) management capability for casualties from current and prior conflicts for all Services. DCIPS is the DOD required system for casualty management (DODI 1300.18). All information contained in the DCIPS data base is classified For Official Use Only (FOUO). This information is governed under the Privacy Act Laws and should not be discussed with those not having a need to know.

**Section VIII****The Transition Function****12-49. Transition Function Overview**

The transition function includes a broad range of activities focused on ensuring Soldiers and their families are treated with dignity and respect and assisted in every way possible as they transition from the AC to a RC and/or civilian status. Selected transition activities are described in greater detail below.

**12-50. The Soldier for Life — Transition Assistance Program**

a. The SFL-TAP orchestrates a broad spectrum of programs and services designed to assist Soldiers in making critical career and transition decisions. SFL-TAP provides transition services to Soldiers, DA civilians, retirees, and their family members. RC personnel are also eligible to receive SFL-TAP services upon serving a minimum of 180 consecutive days of active duty immediately prior to separation.

b. SFL-TAP is not a job placement service but instead a program through which a wide range of services are made available to users through a combination of DOD, Department of Labor, Department of Veteran Affairs, U.S. Army, and contractor provided services. Transition counseling and career planning are the cornerstone services that assist the user to properly focus on their career path and the value of their experience should they remain on active duty or transition to civilian life. Individuals using SFL-TAP services have access to an abundance of reference materials and a wealth of information about benefits, civilian employment opportunities, career planning and services available through many federal, state, and local government agencies.

c. Participation in SFL-TAP is mandatory for all active duty Soldiers who are separating or retiring. Retirees and their families are eligible to use SFL-TAP services for life on a space available basis. Referral to SFL-TAP is mandatory for civilians who are departing because of force alignments, RIFs, or base closures. SFL-TAP participation is optional for transition of family members and eligible RC Soldiers.

d. SFL-TAP establishes a strong partnership between the Army and the private sector, creates a recruiting multiplier, improves employment prospects for transitioning personnel, reduces unemployment compensation costs to the Army, and allows career Soldiers to concentrate on their mission. SFL-TAP is an enduring program, institutionalized into the Army culture and life cycle functions.

### **12-51. The Soldier for Life — Army Retirement Services Program**

a. The Army Soldier for Life Retirement Services Program provides assistance to Soldiers and their Families preparing for and transitioning to retirement, Families of Soldiers who die on active duty and Retired Soldiers, surviving Spouses and their Families. Through a network of Retirement Services Officers (RSOs) at major Army installations, National Guard State Headquarters, and Army Reserve Regional Support Commands worldwide, they: 1) provide counseling to these groups on their rights, benefits and entitlements, 2) assist with Survivor Benefit Plan (SBP) elections, and 3) keep the retiree population informed of law and benefit changes.

b. The HQDA Retirement Services Office provides policy guidance and program oversight to the installation RSOs and develops Army policy and procedures for the Survivor Benefit Plan (SBP) program; publishes Echoes, the newsletter for Retired Soldiers and surviving spouses and their families; develops policy for the operation of the Army Retirement Services Program; and administers the Army Chief of Staff's (CSA) Retiree Council.

### **12-52. Separation**

Separation includes voluntary and involuntary release from active duty, discharge, non-disability retirement, and physical disability retirement. Because the type of discharge and character of service are of such great significance to the Service member, it must accurately reflect the nature of service performed. Eligibility for veterans' benefits provided by law, eligibility for reentry into service, and acceptability for employment in the civilian community may be affected by these determinations.

### **12-53. Enlisted Separation**

a. An enlisted Soldier may be separated upon ETS or prior to ETS by reason of physical disability, sentence of general or special court-martial, or one of the administrative separation programs prescribed in AR 635-200. Both voluntary and involuntary administrative separation actions are outlined in AR 635-200.

b. Voluntary separations are initiated by the Soldier. Reasons include hardship/dependency, surviving family members, acceptance into an ROTC program, orders to active duty as an officer or warrant officer, defective enlistment, pregnancy, for the good of the service in lieu of trial by court-martial, and early separation when denied reenlistment. Soldiers who have tested positive for the Human Immunodeficiency Virus (HIV) antibody may request discharge under Secretarial authority. Soldiers may also be allowed to separate early to further their education.

c. Commanders may initiate involuntary separation proceedings for parenthood, personality disorder, concealment of an arrest record, fraudulent or erroneous entry, alcohol or drug abuse rehabilitation failure, failure to meet body composition/weight control standards, entry-level performance and conduct, unsatisfactory performance, or misconduct. To separate a Soldier involuntarily, the unit commander must notify the Soldier in writing. Any involuntary separation action involving a Soldier with six or more years of total active and reserve military service entitles the Soldier to a hearing by an administrative separation board. If the Soldier has 18 or more years, the board is mandatory and cannot be waived. Administrative discharges of Soldiers with 18 or more years of AFS must be approved at the Army Secretariat level.

d. Discharge certificates are furnished only to Soldiers who are honorably discharged or discharged under honorable conditions. All Soldiers leaving active duty are issued a Department of Defense (DD) Form 214, Certificate of Release or Discharge from Active Duty. The DD Form 214 documents the characterization of service, except when a Soldier is separated while in an entry-level status. Entry-level separations normally have service described as uncharacterized. Honorable, general, and under other

than honorable conditions characters of service are assigned administratively. Bad conduct and dishonorable discharges are issued upon conviction by a court-martial.

#### **12-54. Enlisted Non-Disability Retirement System**

To qualify for voluntary retirement, an enlisted Soldier must be on active duty and have completed 20 or more years of AFS on the retirement date. A Soldier who has completed 20 years, but less than 30 years AFS and who has completed all required service obligations may be retired at his or her request. Enlisted Soldiers who have completed 30 years AFS have the vested right under law to retire and may not be denied unless other provisions of law are invoked (e.g., stop loss). DA policy requires that all service obligations incurred by promotion, schooling, or PCS be completed prior to approval of voluntary retirement of Soldiers with less than 30 years' service. However, a Soldier may request waiver of a service obligation, and approval would depend upon whether the best interests of the Service are involved or whether a substantial hardship might exist should retirement be denied. Enlisted retirements are normally approved by field commanders of general officer rank.

#### **12-55. Officer Non-Disability Retirement System**

a. There are two types of retirement—voluntary and mandatory. To qualify for voluntary retirement, officers must have completed at least 20 years AFS on their retirement date. All service obligations incurred must be completed unless waived by HQDA. Mandatory retirement dates are established by law and only in very rare cases are individuals retained on active duty beyond these dates. Majors, lieutenant colonels, and colonels may remain until 24, 28, and 30 years of Active Federal Commissioned Service (AFCS) respectively, unless involuntarily retired through the SERB process.

b. While majors and below must have served six months in their grade to retire at that grade, lieutenant colonels and colonels must serve three years in grade to retire in that grade unless waived by HQDA. Some programs like the Voluntary Early Release and Retirement Program (VERRP) can waive one year of the three-year obligation, subject to limitations and provisions imposed by Congress. Officers who are selected by SERB retain their grade regardless of time held.

#### **12-56. Physical Disability Separation**

The laws governing physical disability separation from the Army provide for the medical retirement or separation of a Soldier who is determined to be unfit by reason of physical disability when the physical/mental condition(s) significantly interferes with their ability to perform the duties of his or her office, grade, rank, or rating. The severity of the condition(s) determines eligibility for disability benefits, disability retirement, and severance pay. It is possible to receive a non-disability separation and still have physical disabilities, which could affect potential for civilian employment and retirement benefits. Disability compensation for any medical condition that affects a Soldier's quality of life may be determined by Department of Veteran Affairs and is separate from the service separation.

#### **12-57. Integrated Pay and Personnel System-Army (IPPS-A)**

IPPS-A is the Army's future web-based Human Resources (HR) solution to provide integrated HR capabilities across all Army Components. IPPS-A will be launched incrementally in five phases, or "releases," over the coming years. Each release will build upon the system's previous release, starting with IPPS-A's first release. The first release interfaced with 15 personnel systems and built the foundational database of trusted personnel data for all future releases. In addition, this release provided each Soldier access to the Soldier Record Brief, an eventual replacement for the Officer and Enlisted Record Briefs, DA Form 2-1, and nine multi-Component reports for HR Professionals. Release 1 was deployed to the Army in three waves by Component in 2014, including a trusted database. This included the ability for Army National Guard, United States Army Reserve and Active Army Soldiers to view and retrieve their SRB as well as the ability for Leaders, Commanders and administrators to access nine-predefined queries. Release 2 will provide the National Guard with the capabilities that are currently supported by SIDPERS-ARNG. Release 3 will provide the capabilities currently supported by the major field systems for the Army Reserve and Active Army. Pay capabilities will then be introduced to all Components in Release 4 and Release 5 will provide the remaining essential personnel services not previously supported. This approach ensures IPPS-A meets the needs of all its users. IPPS-A will ultimately subsume 45 HR and Pay systems currently in use. Before any system's functions are

# HOW THE ARMY RUNS

subsumed, the Army will conduct an analysis to ensure that each subsumed system's functions can be accomplished with IPPS-A or other systems. Figure 12-10.

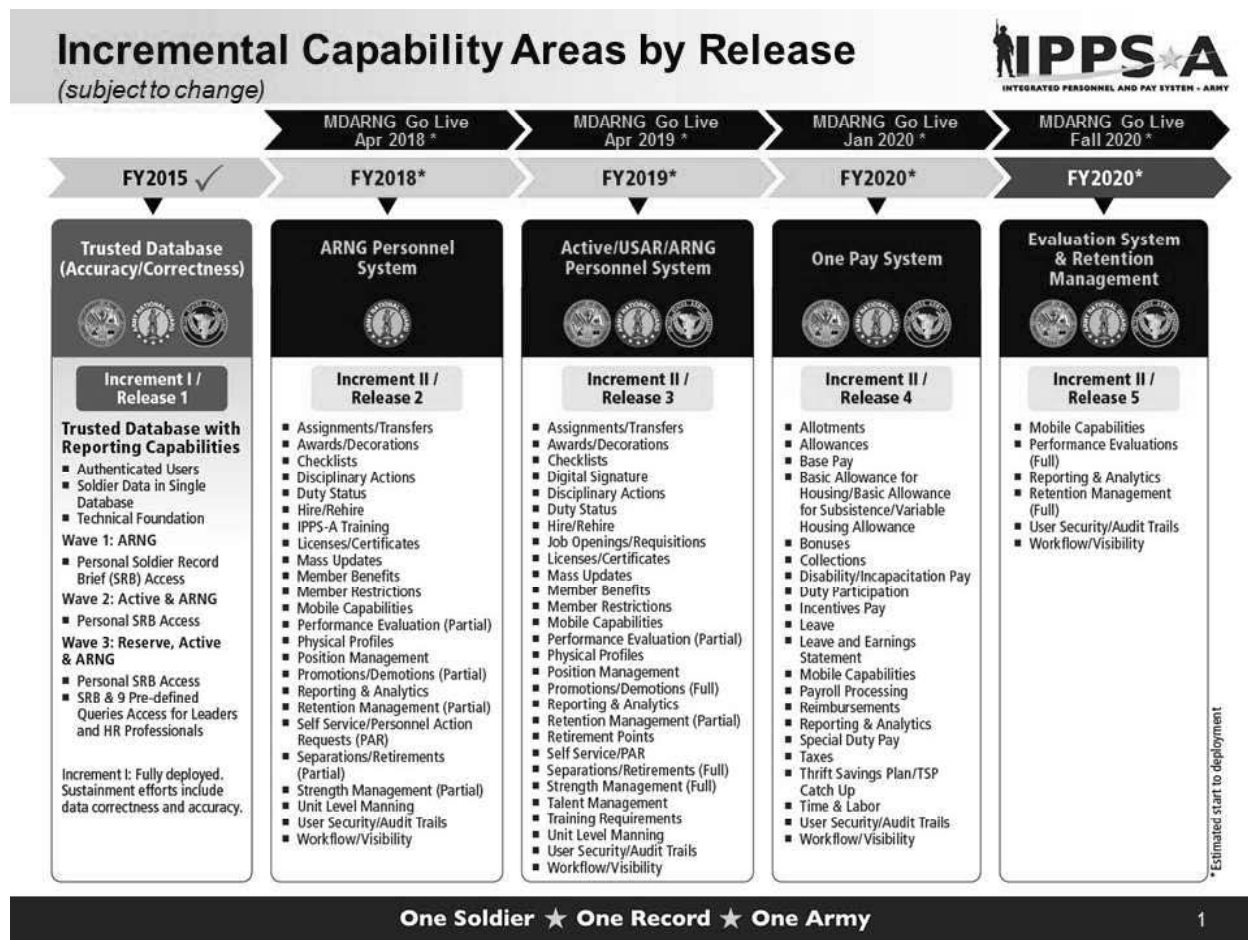

Figure 12-10. IPPS-A Incremental Areas by Release

## Section IX Summary, Key Terms and References

### 12-58. Summary

a. The primary purpose of the MHRM system is to satisfy valid Army requirements and, insofar as practicable, accommodate the legitimate needs of its members. The system is a complex, dynamic, multifaceted mosaic of interacting subsystems, which interface in a variety of ways with all other major Army systems. It must keep up with the rate of change occurring in the Army so that Soldiers are properly supported, and commanders have timely, relevant information on which to base operational decisions.

b. The processes designed to structure, acquire, train, educate, distribute, sustain, professionally develop, and separate Soldiers must be continuously evaluated and refined to ensure they support current and future Army requirements. The subsystems within these processes must have flexibility to meet the needs of the Army. Whether the Army is reducing or expanding, there are a few critical operating principles to guide decision makers as they choose between difficult, challenging options in either scenario: maintain force readiness at the prescribed levels; maintain quality in recruiting, retention, and development programs; make changes in a balanced and orderly way throughout all grades and specialties, both officer and enlisted; maintain current board selection functions to continue to build on the

best; rely on RC; protect well-being; and, finally, in order to reduce uncertainty, ensure there is an understandable, comprehensive plan.

c. This chapter was designed to provide a broad overview of major personnel management systems. During the next several years, the policies, functions, and processes within every one of the subsystems will be continuously challenged to ensure Army requirements are satisfied and to care for its most important resource: people.

### 12-59. Key Terms

a. End Strength. The total number of personnel authorized by the Congress to be in the Army on the last day of the Fiscal Year (FY) (30 September). This is normally provided in the National Defense Authorization Act (NDAA).

b. Force Structure Allowance (FSA). The sum of authorized spaces contained in all Modification Tables of Organization and Equipment (MTOE) units and Table of Distribution and Allowances (TDA) type organizations.

c. Total Strength. The total of all personnel serving on active duty in the Army, including Soldiers in units and organizations and those in the individuals account.

d. Operating Strength (OS). Those Soldiers available to fill spaces in MTOE units and TDA organizations, sometimes referred to as the distributable inventory.

e. Individuals Account. This account, often referred to as the Trainee, Transient, Holdee, and Student (TTHS) account, is comprised of those personnel unavailable to fill spaces in units. The six sub-accounts are trainees, officer accession students, transients, holdees (short explanation needed), students, and U.S. Military Academy (USMA) cadets.

### 12-60. References

a. Regulations:

- (1) Army Regulation (AR) Series Title 600, Personnel—General.
- (2) AR Series Title 601, Personnel Procurement.
- (3) AR Series Title 614, Assignments, Details, and Transfers.
- (4) AR Series Title 621, Education.
- (5) AR Series Title 623, Evaluations.
- (6) AR Series Title 624, Promotions.
- (7) AR Series Title 635, Personnel Separations.
- (8) AR Series Title 680, Personnel Information Systems.
- (9) Field Manual 1-0, Human Resources Support.
- (10) “Initial Message to the Army,” General Mark A. Milley, 26 Aug 15.

b. Useful Links:

- (1) <http://www.army.mil>.
- (2) <http://www.armyg1.army.mil>.
- (3) <http://www.asamra.army.pentagon.mil>.
- (4) <http://www.usarec.army.mil>.
- (5) <http://www.goarmy.com>.
- (6) <https://www.hrc.army.mil>.
- (7) <https://www.goarmyed.com>.

**This page is intentionally left blank**



## Chapter 13

### Civilian Human Resource Management

#### Section I Introduction

##### 13-1. Chapter Content

a. Civilians have been an important component of the Army since the Revolutionary War. They are an integral part of the force in accomplishing today's multiple complex missions. The Secretary of the Army (SECARMY) established the Army Civilian Corps and the Army Civilian Corps Creed on 19 June 2006. This name unifies those in the Army Civilian service and embodies the commitment of the dedicated individuals serving as a fundamental part of the Army team. Army civilians serve in all theaters and are deployed worldwide to support the Army mission and Overseas Contingency Operations. The purpose and role of an Army civilian is defined by the Army Civilian Corps Creed:

I am an Army Civilian—a member of the Army team.

I am dedicated to our Army, our Soldiers and Civilians.

I will always support the mission.

I provide stability and continuity during war and peace.

I support and defend the Constitution of the United States and consider it an honor to serve our nation and our Army.

I live the Army values of loyalty, duty, respect, selfless service, honor, integrity, and personal courage.

I am an Army Civilian.

b. The Army Civilian Corps includes Appropriated Fund (APF) and Non-Appropriated Fund (NAF) employees, as well as foreign or local national employees (see Fig 13-1 for details). These civilians are employed in over 530 different occupations with the highest concentration serving in logistics, research and development, and Base Operations (BASOPS) functions. Civilians are excluded from positions by law requiring military incumbents but are increasingly being used in combat service support functions as former military positions are converted to civilian occupancy.

c. An understanding of the types of employees and the rules and regulations governing each of them is necessary to understand the management and administrative environment within which civilian personnel management systems operate. The laws, regulations, personnel policies, and practices differ for Army civilian employees based on their source of funding.

##### 13-2. Categories of Civilian Personnel

a. APF Civilians. *APF or appropriated funds* refers to those funds provided by Congress, normally in annual Defense Appropriations Act legislation. U.S. citizens and eligible U.S. aliens are paid from APFs and are managed within a structure of federal civil service laws. APF employees are further divided into two categories based on the nature of work performed. Military-function civilians perform support duties associated directly with the Army's National Military Strategy (NMS) objectives. Civil-function civilians perform duties associated with the Army's civil works program administered by the Army Corps of Engineers. Civil works includes planning, design, construction, operation and maintenance of projects that improve the nation's water resource infrastructure (e.g., navigation, flood control, and hydroelectric power, plus other civil functions prescribed by law). The laws governing APF employees are administered by the U.S. Office of Personnel Management (OPM) and will be discussed in more detail in subsequent sections of this chapter.

b. NAF Civilians.

(1) NAF employees are paid from funds generated from sales, fees, and charges to authorized patrons. This category is comprised of U.S. civilians, foreign nationals (usually from the local labor market), and

enlisted service personnel working part time during off-duty hours. All compete for employment on the basis of merit.

(2) NAF employees play an important role in providing Family and Morale, Welfare and Recreation (FMWR) services to military personnel and their family members. Army clubs, Army lodging, child care centers, craft shops, bowling centers, swimming pools, gymnasiums and other NAF activities employ a considerable number of employees at most Army installations and contribute to the overall quality of life.

c. Foreign/Local National Civilians. The Army also employs foreign and local nationals in both APF and NAF positions in overseas areas. The Status of Forces Agreement (SOFA) in effect with a given host country forms the basis of the employment systems for these employees. Within this framework, employee administration must be consistent with host country practice, U.S. law, and the management needs of the Army. In some cases the host government may reimburse the salary and associated personnel costs in whole or in part.

### **13-3. Army Workforce Mix**

a. The Army's fighting environment has changed, causing the Army to transform. The number and scope of the missions the Army must perform has grown significantly since the end of the Cold War. Following the post-Cold War drawdown that ended in 1999, the number of Army civilian employees increased modestly through Fiscal Year (FY) 2004. During FY 2005 to FY 2010, the numbers increased significantly due to migration of Overseas Contingency Operations missions to base missions, Grow the Army budget initiatives such as increases for base support functions, contractor to civilian conversions, military pay re-capitalization, and conversion of military billets to civilian positions. Civilian increases are not likely to continue into the future considering budget and deficit reduction deliberations currently underway.

b. The Army is undergoing a fundamental change in how it defines its total manpower. The challenge is achieving the right balance of civilian employees, contracted personnel, and Soldiers in our Army.

### **13-4. Decentralized Management**

The systems for recruiting, utilizing, developing, and sustaining Department of Army (DA) civilians are predominantly decentralized. Decentralized management of civilians is very different from the centralized management of military personnel (Figure 13-1). Most authorities for the supervision and management of civilians have been delegated through the chain of command to the lowest practicable level. Certain civilian personnel functions are performed on a regional, command-wide, or DA-wide basis when doing so results in more efficient operations (e.g., the Army Benefits Center-Civilian (ABC-C) at Fort Riley provides counseling to individual employees across the Army on their benefits and automated support for benefits changes) or when a managerial perspective above the local level is required to meet program objectives (e.g., Headquarters, Department of the Army (HQDA) manages the intake and training of interns in DA career programs). The management of Senior Executive Service (SES) employees is also centralized at HQDA level.

## **Section II Organization of Civilian Personnel Management**

### **13-5. Merit System Principles**

a. The Merit System Principles are nine basic standards governing the management of the executive branch workforce. The principles are part of the Civil Service Reform Act of 1978 and can be found at Title 5 United States Code (USC) § 2301. The following merit principles govern all personnel practices.

(1) Recruitment should be from qualified individuals from appropriate sources in an endeavor to achieve a workforce from all segments of society. Selection and advancement should be determined solely on the basis of relative ability, knowledge and skills after fair and open competition which assures all receive equal opportunity.

(2) All employees and applicants for employment should receive fair and equitable treatment in all aspects of personnel management without regard to political affiliation, race, color, religion, national origin, sex, marital status, age, or handicapping condition (sic - the preferred term is disability) with proper regard for privacy and constitutional rights.

(3) Equal pay should be provided for work of equal value, with appropriate consideration of both national and local rates paid by employers in the private sector, and appropriate incentives and recognition should be provided for excellence in performance.

(4) All employees should maintain high standards of integrity, conduct, and concern for the public interest.

## Differences Between the Military and Civilian Systems

Category	Military	Civilian
Statute	Title 10, United States Code	Title 5, United States Code
Authority	Rank in Person	Rank in Job
Acquisition	Fill based on structure and authorizations; managed by United States Army Recruiting Command, United States Military Academy, Cadet Command, Human Resources Command, Army G-1	Fill based on position vacancy; managed by supervisor, Commander, Civilian Personnel Advisory Center, Career Program Manager, Assistant Secretary of the Army for Manpower & Reserve Affairs
Individual Training	Hierarchy of schools for military and leadership skills	Functional training primarily occupation-related
Distribution	Mandatory movement to meet worldwide requirements	Voluntary mobility (generally)
Deployment	Involuntary (based on Army requirements)	Voluntary (unless part of job criteria)
Professional Development	Central selection and management	Heavy decentralized management
Transition	Contractual obligation and forced separation / retirement	More individual choices and longer tenure

Figure 13-1. Differences Between the Military and Civilian Systems

(5) The federal work force should be used efficiently and effectively.

(6) Employees should be retained on the basis of adequacy of their performance. Inadequate performance should be corrected. Employees should be separated who cannot or will not improve their performance to meet required standards.

(7) Employees should be provided effective education and training in cases in which such education and training will result in better organizational and individual performance.

(8) Employees should be protected against arbitrary action, personal favoritism, or coercion for partisan political purposes, and prohibited from using their official authority or influence for the purpose of interfering with or affecting the result of an election or a nomination for an election.

(9) Employees should be protected against reprisal for the lawful disclosure of information which an employee reasonably believes evidences a violation of any law, rule, or regulation, or evidences mismanagement, a gross waste of funds, an abuse of authority, or a substantial and specific danger to public health or safety.

b. Twelve prohibited personnel practices are defined by law at § 2302(b) of Title 5 of the U.S.C. Any employee who has authority to take, direct others to take, recommend, or approve any personnel action, shall not, with respect to such authority -

- (1) Discriminate for or against an employee or applicant for employment—
  - (a) On the basis of race, color, religion, sex, or national origin, as prohibited under section 717 of the Civil Rights Act of 1964 (42 U.S.C. 2000e-16);
  - (b) On the basis of age, as prohibited under sections 12 and 15 of the Age Discrimination in Employment Act of 1967 (29 U.S.C. 631, 633a);
  - (c) On the basis of sex, as prohibited under section 6(d) of the Fair Labor Standards Act of 1938 (29 U.S.C. 206 (d));
  - (d) On the basis of handicapping condition, as prohibited under section 501 of the Rehabilitation Act of 1973 (29 U.S.C. 791); or
  - (e) On the basis of marital status or political affiliation, as prohibited under any law, rule or regulation.
- (2) Solicit or consider employment recommendations based on factors other than personal knowledge or records of job-related abilities or characteristics.
- (3) Coerce the political activity of any person (including providing any political contribution or service) or take any action against any employee or applicant for employment as a reprisal for the refusal of any person to engage in such political activity.
- (4) Deceive or willfully obstruct anyone from competing for employment.
- (5) Influence anyone to withdraw from competition for any position so as to improve or injure the employment prospects of any other person.
- (6) Give an unauthorized preference or advantage to anyone so as to improve or injure the employment prospects of any particular employee or applicant.
- (7) Engage in nepotism (i.e., hire, promote, advance, or advocate the hiring or promotion of relatives to a civilian position).
- (8) Engage in reprisal for whistle blowing (i.e., take, fail to take, threaten to take or fail to take a personnel action with respect to any employee or applicant because of any disclosure of information by the employee or applicant that he or she reasonably believes evidences a violation of a law, rule or regulation; gross mismanagement; a gross waste of funds; an abuse of authority; or a substantial and specific danger to public health or safety (if such disclosure is not barred by law and such information is not specifically required by Executive Order (EO) to be kept secret in the interest of national defense or the conduct of foreign affairs—if so restricted by law or EO, the disclosure is only protected if made to the Special Counsel, the Inspector General, or a comparable agency official)).
- (9) Take, fail to take, threaten to take or fail to take a personnel action against an employee or applicant for exercising an appeal, complaint, or grievance right; testifying for or assisting another in exercising such a right; cooperating with or disclosing information to the Special Counsel or to an Inspector General; or refusing to obey an order that would require the individual to violate a law.
- (10) Discriminate based on personal conduct which is not adverse to the on-the-job performance of an employee, applicant, or others.
- (11) Take or fail to take, recommend, or approve a personnel action if taking or failing to take such an action would violate a veterans' preference requirement.
- (12) Take or fail to take a personnel action, if taking or failing to take action would violate any law, rule or regulation implementing or directly concerning merit system principles at Title 5 USC § 2301.

### **13-6. United States Office of Personnel Management**

a. OPM is the personnel agency of the executive branch charged with the mission to administer most federal laws and EOs dealing with all aspects of civilian personnel management and administration in the federal sector. Some laws and EOs place certain personnel management responsibilities directly on agency and department heads, subject to OPM policy and review. In other cases, OPM retains the authority to establish specific program standards and regulate and control the means of carrying out major aspects of agency or departmental personnel management operations.

b. OPM develops proposals for federal personnel legislation and EOs and develops and publishes specific policies, procedures and regulations implementing federal personnel laws and EOs. OPM also provides testing, evaluation, and referral of job applicants to agencies; evaluates agency personnel management systems; provides advice and assistance to agencies in the development of effective personnel management programs; provides oversight on Department of Defense (DOD) evaluations and assessments of human capital policies, programs, and practices. In addition, OPM develops standards

by which jobs are classified (i.e., pay systems, title, job series, and grades); administers retirement, health, and life insurance programs; and adjudicates position classification appeals.

c. OPM executes, administers, and enforces civil service rules and regulations through audits, reviews and inspections. Failure on the part of agencies to observe the prescribed standards, requirements, and instructions may result in the withdrawal of personnel management authority delegated by OPM.

d. NAF employees are not legally deemed to be employees of the Federal Government for the purposes of most laws administered by the Office of Personnel Management, therefore the policies, procedures, and entitlements relating to employees paid from appropriated funds and those relating to NAF employees are different. There are, however, instances where legislation not applicable to NAF employees has been administratively adopted.

### 13-7. Other Agencies with Federal Government-Wide Authority

In addition to OPM controls and procedures, four separate, independent federal agencies also provide oversight to ensure agencies adhere to principles of merit, labor relations guarantees, and equal employment rights:

a. U.S. Merit Systems Protection Board (MSPB). The MSPB is an independent, quasi-judicial agency in the executive branch that serves as the guardian of federal merit systems. The board's mission is to protect federal merit systems and the rights of individuals within those systems. NAF employees are not covered under MSPB. MSPB carries out its statutory responsibilities and authorities primarily by adjudicating individual employee appeals and by conducting merit systems studies. In addition, MSPB reviews significant actions by the OPM to assess the degree to which those actions may affect merit.

(1) Cases arising under the MSPB jurisdiction include the following:

(a) Employee appeals of agency adverse actions, including removals, suspensions of more than 14 days, reductions in grade or pay, furloughs of 30 days or less, reduction-in-force actions, denials of within grade salary increase.

(b) OPM suitability determinations.

(c) OPM determinations in retirement matters.

(d) Disciplinary actions brought by the Office of Special Counsel (OSC) alleging violations of the Hatch Act (coercion of government employee political activity).

(e) Corrective and disciplinary actions brought by the OSC against agencies or federal employees who are alleged to have committed certain prohibited personnel practices or alleged to have violated certain civil service laws, rules, and regulations.

(f) Requests for stays of personnel actions alleged by the OSC to result from certain prohibited personnel practices.

(g) Requests for review of regulations issued by OPM or of implementation of OPM regulations by an agency.

(h) Informal hearings in cases involving proposed performance-based removals from the Senior Executive Service.

(2) The MSPB also has jurisdiction over allegations of employment discrimination in connection with actions otherwise appealable to the MSPB and certain employee allegations subject to a negotiated grievance procedure covering actions otherwise appealable to the MSPB.

b. Office of Special Counsel (OSC). The OSC is an independent federal investigative and prosecutorial agency. OSC's authority comes from four federal statutes: the Civil Service Reform Act (CSRA), the Whistleblower Protection Act, the Hatch Act (legal restrictions on government employee political activity), and the Uniform Services Employment and Reemployment Rights Act (USERRA). OSC's primary mission is to safeguard the merit system by protecting federal employees and applicants from prohibited personnel practices, especially reprisal for whistle blowing. Sexual orientation and parental status employment discrimination are designated as prohibited personnel practices by EO. Allegations of employment discrimination on these bases may be filed with and subject to investigation by the OSC.

c. Federal Labor Relations Authority (FLRA). The FLRA is an independent administrative federal agency which adjudicates federal employee collective bargaining disputes, including resolving complaints of unfair labor practices, determining appropriateness of units for labor organization representation, adjudicating exceptions to arbitrator's awards, adjudicating legal issues relating to duty to bargain and negotiability, and resolving impasses during negotiations.

d. The Equal Employment Opportunity Commission (EEOC). EEOC is an independent federal agency responsible for enforcing federal laws which prohibit employment discrimination in both the private and public sector based on race, color, national origin, sex, age (40 and older), religion, genetic information, mental or physical disability or in reprisal for engaging in protected activity such as opposing discrimination or participating in a discrimination complaint or lawsuit. The EEOC provides oversight and coordination of all federal sector equal employment opportunity regulations, practices and policies, and submits an annual report on the federal workforce to the President of the United States (POTUS), Congress, and appropriate congressional committees. The EEOC's regulation implementing the federal sector Equal Employment Opportunity (EEO) program (29 Code of Federal Regulations (CFR) 1614), requires each federal agency to implement and maintain effective EEO programs. The EEOC Administrative Judges (AJ) play an adjudicative role in formal federal sector EEO complaints as well as at the appellate level of the administrative complaint process. EEOC findings of discrimination are not appealable by agencies in federal court.

### **13-8. Department of Defense**

Under EO 9830, the POTUS delegated authority to agency heads, including the Secretary of Defense (SECDEF) to act in civilian human resource matters in accordance with applicable policies, program requirements, standards, and instructions.

a. Office of the Secretary of Defense (OSD). Within OSD, the Under Secretary of Defense (Personnel and Readiness) (USD(P&R)) and the Deputy Assistant Secretary of Defense (Civilian Personnel Policy) (DASD(CPP)) have responsibility for DOD-wide Civilian Human Resource (CHR) policy. The DASD(CPP) develops plans, policies, and programs to manage the DOD civilian workforce, including NAF and local national employees in coordination with the services and within the framework established by federal law, EOs, and government-wide regulations. Through its Defense Civilian Personnel Advisory Services (DCPAS), the DASD(CPP) also provides certain civilian human resource services on a DOD-wide basis.

b. DOD Investigations and Resolutions Division (DOD IRD). The IRD investigates and facilitates the resolution of EEO complaints and formal employee grievances not covered by negotiated grievance procedures. In a complex formal grievance of a NAF employee, or a formal grievance of an APF employee under the Administrative Grievance System, the deciding official may elect to retain the services of the IRD to review the facts and make recommendations.

### **13-9. Assistant Secretary of the Army for Manpower and Reserve Affairs**

a. DA authority for civilian personnel management is further delegated by the SECDEF to the SECARMY. The SECARMY in turn has delegated some of the civilian personnel management responsibilities including responsibility for personnel policy, programming, and oversight to the ASA(M&RA) through General Order No. 2017-01, 5 Jan 2017. The SECARMY retains appointing and pay setting authority for Civilian Executive and Senior Professional (ESP) personnel (except for those appointed by the POTUS or other higher level authority). This includes positions in the SES, Defense Intelligence Senior Executive Service (DISES), Scientific and Technical (ST) Professionals, Senior Level (SL) and Defense Intelligence Senior Level (DISL), as well as Highly Qualified Expert (HQE) positions. By memo dated 3 August 2009, the SECARMY delegated to the ASA(M&RA) authority, direction, and control over missions, functions, and personnel of the Civilian Senior Leader Management Office (CSLMO). The Deputy Chief of Staff, G-1 (DCS, G-1) is the responsible official to the ASA(M&RA) in developing, coordinating, and implementing programs and policies directly associated with accession, development, distribution, and sustainment of military and civilian personnel. The Assistant G-1 for Civilian Personnel (AG-1 CP) has responsibility for supervision of civilian personnel policy, management, and related civilian personnel functions in the Army.

b. Appointing authority, which is the authority to approve personnel actions, is delegated to the Commanders of the Army Commands, the Commanders of the Army Service Component Commands, the Commanders/Superintendent of the Direct Reporting Units and the Administrative Assistant to the SECARMY. In order to streamline the execution of the DA's civilian personnel program, the Army's Civilian Human Resources Agency (CHRA), through the CHRA Regional Directors or their designees, authenticates civilian personnel actions for their serviced organizations. Such personnel officials will act on behalf of the appointing authorities in authenticating actions. Authenticating officials may electronically

approve a personnel action only after the responsible management official has approved the action, determined it's in accordance with law and regulation, and exercised appropriate fiduciary responsibility to ensure fiscal soundness. The authenticating official is responsible for ensuring personnel actions are in compliance with applicable civilian personnel laws, rules, regulations and governing policies before processing the actions and thus serves as the appointing official. An example is provided to illustrate this "act for" relationship: whenever a regional processing center approves and processes an official personnel action (such as the appointment of someone to a position), it does so on behalf of the commander of the serviced organization, thus exercising that commander's personnel management authority. Regional and Civilian Personnel Advisory Center (CPAC) directors are directly responsible to each of the commanders they serve for the proper exercise of this authority.

### **13-10. Other Army Organizations with Civilian Personnel Responsibilities**

a. Installation Management Command (IMCOM) G-9. IMCOM G-9's mission is to develop and administer systems and programs for the Army family and community activities under the general heading of Family and Morale, Welfare, and Recreation (FMWR). IMCOM G-9 in conjunction with the Talent Management Program is responsible for filling specified MWR managerial jobs (both APF and NAF) and administration of a benefits program for all Army NAF employees.

b. Intelligence Personnel Management Office (IPMO). The IPMO is a subordinate element of the Office, Deputy Chief of Staff, G-2, HQDA. It serves as the focal point in the Army for policy and management of the Defense Civilian Intelligence Personnel System (DCIPS) and reports jointly to the Army Deputy Chief of Staff for Intelligence (G-2) and the ASA(M&RA). The IPMO maintains liaison with the rest of federal intelligence on Civilian personnel management issues, develops policies and programs, and develops and provides training and guidance. The IPMO also provides personnel management advice and assistance to CPACs that, in turn, provide Civilian personnel management support to intelligence organizations or those with DCIPS employees.

## **Section III**

### **Civilian Human Resource Service Delivery**

#### **13-11. Civilian Personnel Advisory Centers**

a. Advisory functions requiring face-to-face interaction between Human Resources Specialists, managers and employees typically reside at the CPAC (installation/activity level). Action processing, record keeping, and database management functions are centralized at regional processing centers. The Army has established geographically based Regional Offices and Civilian Personnel Records Centers. The Regional Offices provide oversight and guidance to CHRA's CPACs throughout the world which are responsible for providing comprehensive operational lifecycle HR services, advice, and support to installations/activities and their employees. Each CPAC is typically located at or near the installation(s) to which it provides advisory services.

b. Specific responsibilities of the CPACs are as follows.

(1) Provide the civilian personnel service and assistance necessary to obtain, compensate, develop, use and retain an effective civilian workforce as well as to maintain the order and discipline of the civilian force.

(2) Promote equality of opportunity in the organizational units serviced.

(3) Coordinate personnel management requirements and needs of the organizations serviced.

(4) Provide information and staff assistance and guidance to managers and supervisors to assist them in obtaining the most effective use of civilians through improved management.

(5) Assist commands at the installation and activity level in establishing labor management relationships focused on supporting and enhancing the Army's national security mission and creating and maintaining a high-performance workplace delivering the highest quality products and services at the lowest possible cost. Such relationships should be committed to pursuing solutions that promote increased quality and productivity, customer service, mission accomplishment, efficiency, quality of life, employee empowerment, organizational performance, and military readiness. Consensual means of resolving disputes, such as alternate dispute resolution and interest based bargaining, should be sought.

c. NAF HR Offices are fully functional Human Resources operations and are located within the CPAC. All NAF HR functions are performed in the NAF HR Office.

### 13-12. Automation Tools

a. It is Department of Defense (DOD) policy that Information Technology (IT) investments will be managed as portfolios to: ensure IT investments support the Department's vision, mission, and goals; ensure efficient and effective delivery of capabilities to support the warfighter; and maximize return on investment to the enterprise. The enterprise portfolio consists of CHRM-IT systems providing capabilities across the spectrum of the end-to-end human resources (HR) life cycle. Reference Department of Defense Instruction Number 1400.25, Volume 1100.

b. The DOD has a single enterprise-wide mandated CHRM-IT solution consisting of a set of CHRM-IT systems. This includes the Defense Civilian Personnel Data System (DCPDS) that uses a standard configuration for personnel action processing, reporting, and data retrieval. Army continues to use Army-specific systems in addition to existing enterprise-wide systems, until enterprise-wide solutions are acquired or developed. Below are just a few systems used to accomplish the civilian HR mission:

(1) Defense Civilian Personnel Data System (DCPDS). DCPDS contains the world's largest relational database, housing and processing all of DOD's civilian HR data. The system is designed to support APF, NAF, and local national HR operations. DCPDS offers a comprehensive array of state-of-the-art personnel processing capabilities. Managers can access organizational, historical, and employee data through a variety of reports and individual screens. Features include MyBiz+, Employment Verification, Personnel Actions, and Personnel Information.

(2) CPOL Portal. CPOL contains policy and guidance documents on the management and administration of the Army civilian workforce including newsletters, bulletins, operating manuals, directives, forms, per diem rates, and salary schedules. CPOL Portal is a one-stop secure site which provides Army civilian employees, managers and HR Specialists access to a private portal with a complete set of employment-related resources, links and web-based applications.

(3) Automation Innovation Center (AIC) and AutoNOA. As a strategic Civilian Human Resources partner, AIC and AutoNOA continue to make positive, visionary differences in maximizing CHRA's ability to meet the needs of an evolving workforce while increasing quality and quantity of automated output in overall support of the Army Soldier.

(4) Business Objects. The Business Objects Xi (BOXi) is a web based, user friendly report building system used to view and create reports on Army Civilian Personnel data.

(5) Electronic Official Personnel Record (eOPF). The eOPF contains official benefit, personnel action, and position related documents spanning an employee's Federal career.

(6) Employee Benefits Information System (EBIS). EBIS allows employees online access to view and change their Civilian benefits, such as health and life insurance.

(7) Fully Automated System For Classification (FASCLASS). FASCLASS is a centralized system that delivers position classification and position description information to the customer's desktop. It provides online access to active position descriptions and organizational information.

(8) Defense Enterprise Hiring Solution (DEHS): USA Staffing and USAJOBS. USAJOBS is the federal government's official source for federal job listings and employment opportunity information. Job seekers can access thousands of job opportunities across hundreds of federal agencies and organizations, allowing agencies to meet their legal obligation (5 USC 3327 and 5 USC 3330) of providing public notice for federal employment opportunities. Once a job seeker locates a vacancy of interest, USAJOBS passes the applicant to one of several approved talent acquisition systems for application intake, evaluation, referral, and selection. USA Staffing is the DEHS talent acquisition system.

## Section IV

### Personnel Management at Installation / Activity Level

#### 13-13. Personnel Management Responsibility and Authority

The responsibility for providing day-to-day leadership of Army civilians resides primarily at installation and activity level with the supervisor, manager, and commander. The SECARMY has delegated personnel management authority, except for management of ESP resources, to commanders with authority to



further delegate to commanders of independent field activities. Thus the actual management of DA civilians, including professional development, incentive awards, discipline, evaluation, labor relations, and most other life cycle personnel functions is decentralized to installation and activity commanders and local managers and supervisors. The CPAC assists the chain of command in exercising this responsibility. In the case of ESPs, centralized management is the responsibility of CSLMO.

#### **13-14. Commander Responsibilities**

Installation commanders are responsible for leading and managing civilian employees and are held accountable for effectively employing their HR assets. Responsible commanders develop, empower and use subordinate supervisors, managers and the CHR staff to establish a work environment for positive employee motivation and high performance. Specific command responsibilities are to carry out civilian personnel management policies, procedures and programs as set forth in Title 5 USC Government Organizations and Employees; Title 5 Code of Federal Regulations Administrative Personnel; and DOD 1400.25-M DOD Civilian Personnel Manual; 5 CFR Parts 410 and 412, Training; Supervisory, Management and Executive Development, and other applicable laws and regulations, consistent with applicable negotiated agreements.

#### **13-15. Supervisor Responsibilities**

a. Commanders generally delegate authority for leading and managing civilian employees to subordinate managers and supervisors. This carries with it specific responsibilities to do the following.

- (1) Maintain accurate position descriptions.
- (2) Recruit, select, assign, and set pay for employees.
- (3) Evaluate employee performance, and train and develop employees.
- (4) Administer award and incentive programs.
- (5) Maintain management-employee communications.
- (6) Communicate employee expectations, administer constructive discipline, and promptly address employee performance deficiencies.
- (7) Maintain a positive labor-management relations program.

b. Supervisor responsibilities in each of these areas and the functional systems established to assist in carrying out these responsibilities are described below.

c. The Army has an informal civilian mentoring program. The Army Mentorship Program was created to reemphasize, reinvigorate, and increase mentorship throughout the Army.

(1) Supervisors should motivate employees to seek mentors through the Army's Mentorship Resource Center.

(2) DA pamphlet 690-46 Mentoring for Civilian Members of the Force provides further guidance.

#### **13-16. Position Classification and Pay**

a. Position Classification and Pay for APF Positions.

(1) Position classification authority is delegated to managers and supervisors within the Army, who may further delegate to CHRA for day to day operation. Individual positions are classified by comparison with the appropriate classification standards or guides. These are established by OPM or DOD based on comprehensive occupational studies of representative work found in the federal service. Army regulations assign responsibility for maintaining accurate job descriptions to supervisors. Differences in grades and pay must be attributed to differences in the difficulty, responsibility, and skill requirements of jobs.

(2) Most positions are covered by the following pay systems: the General Schedule (GS); Personnel demonstration projects (which cover white-collar workers in professional, administrative, technical, clerical, and protective occupations); and the Federal Wage System (FWS), which covers workers in trades, crafts, labor, and similar occupations. Salary rates for most GS positions, including locality pay, are based on surveys of private sector salary rates conducted by the Department of Labor. FWS wage rates are established based on local surveys of private sector rates conducted by federal agencies in accordance with OPM policies. Personnel demonstration projects operate under broad pay band systems rather than the GS.

(3) Personnel demonstration projects authorized by the Defense Authorization Acts of FY 1995, FY 1996, and FY 1998, operate under broad pay band systems rather than the GS schedule. Classification

authority in these systems is delegated only to appropriate management officials. These officials classify positions by a comparison of duties and responsibilities with the appropriate broadband or factor-level descriptors as outlined in the demonstration projects' federal register notices. Typically occupations with similar characteristics are grouped together into career paths, such as Engineering/Science, Business / Technical and General Support. Depending on the demonstration project, each career path may have two to six pay bands. Pay bands allow managers flexibility in setting pay within a band. Salary rates for personnel demonstration project employees generally include staffing supplements, which are usually administered in the same manner as locality pay for GS. Employees progress through pay bands according to job performance. Management officials may also use recruitment, retention, and relocation incentives and other pay flexibilities as discussed in paragraph 14-17 below.

b. Position Classification and Pay for NAF Positions.

(1) The DOD NAF uses a pay band system for position classification and pay. Pay banding involves the establishment of several broad salary bands and allows managers to set individual salaries within an established pay band. This enables NAF managers to provide high-performing NAF employees with greater compensation short of a promotion action or performance award. The DOD pay band system includes NAF clerical, administrative, sales, technical, managerial, executive, professional, and personal service positions exclusive of childcare giving and crafts and trades positions.

(2) There are six pay bands, which are referred to as pay levels and identified using codes Non-Appropriated Fund (NF)-1 through NF-6. They have minimum and maximum pay rates that are overlapping. The minimum and maximum rates for the first two levels and minimum level for NF-3 are determined by locality-based wage surveys of comparable private sector jobs. The maximum rates for NF-3 and the rates for NF-4 through NF-6 are related to the GS and SES pay range.

(3) Child caregiving pay band positions are covered by a separate pay band system implemented in consonance with the DA Caregiving Personnel Pay Program. There are two pay bands, also referred to as pay levels, and they are distinctly identified through use of terms Pay Band I or Pay Band II. The range in pay for child care giving pay band positions is equal to the hourly rate of pay for a GS-2, Step 1, through GS-5, Step 10, and pay rates prescribed for GS child care giving positions also apply. The DA Caregiving Personnel Pay Program (CPPP) was expanded in February 1999 to include positions in Youth Services having similar duties and responsibilities. The current Child and Youth Personnel Pay Program (CYPPP) follows the same guidelines established for the CPPP.

(4) Crafts and trades positions are not affected by pay banding. Pay is determined through the prevailing rate system used for those positions covered under the FWS.

c. Position Classification and Pay for Foreign National Positions. These positions are generally not included in either of the pay systems described above. Employees in these positions are paid under local host-nation pay scales and conditions.

### **13-17. Recruitment, Selection, and Assignment**

a. Management has the right to consider candidates from all appropriate sources, including but not limited to merit promotion, reinstatement and transfer eligibles, Veterans Employment Opportunity Act (VEOA) eligibles, individuals with severe physical or mental disabilities, family member eligibles under EO 12721 and 13473, and those certified as eligible for appointment by OPM or under a delegated examining authority. In deciding which sources to tap, management should consider sources expected to produce candidates who will meet the agency's mission requirements, contribute new ideas and viewpoints and meet the agency's affirmative action and special employment programs. Recruitment sources also encompass the Pathways Programs created under Executive Order 13562, Recruiting and Hiring Students and Recent Graduates. The Pathways Programs includes the Internship Program, Recent Graduates Program and the Presidential Management Fellows Program and are described below. Persons with statutory or priority placement rights to a vacancy must be given appropriate consideration before the normal recruitment process may proceed.

(1) Recent Graduates Program. This program targets recent graduates of trade and vocational schools, community colleges, universities, and other qualifying institutions. To be eligible, applicants must apply within two years of degree completion (except for veterans precluded from doing so due to their military service obligation, who will have six years after degree completion). Successful applicants will be placed in a 1 or 2-year career development program. Those who successfully complete the program may be considered for noncompetitive conversion to career/career conditional appointments.

(2) Internship Program. The program provides students in high schools, community colleges, four-year colleges, trade schools, career and technical education programs, and other qualifying educational institutions and programs with paid opportunities to work in agencies and explore federal careers while still in school. Students who successfully complete the program may be eligible for noncompetitive conversion to career/career conditional appointments.

(3) Presidential Management Fellows Program. This program aims to attract to the federal service outstanding men and women from a variety of academic disciplines at the graduate level who have a clear interest in, and commitment to, the leadership and management of public policies and programs. Successful completion may lead to noncompetitive conversion to a career/career conditional appointment. Personnel selection decisions must be based solely on merit based and job-related reasons.

b. In recent years, DA, like other employers, has found the recruitment and retention of highly skilled employees a challenge, particularly for jobs in shortage occupations or in locations with an especially tight labor market. Due to an anticipated wave of retirements, and the recent downsizing of the federal government DA anticipates difficulty in filling mission critical vacancies in a highly competitive environment. It is important supervisors and managers are aware of the special incentives available for staffing positions with unusual recruitment and retention challenges. These incentives may include recruitment incentives, relocation incentives, retention incentive superior qualifications appointments (appointment at a rate above the minimum for the GS grade because of superior qualifications or a special need for the candidate's services) and special salary rates (minimum rates and rate ranges above those of the GS). In addition, activities may identify local shortage positions for purposes of paying first duty station and pre-employment interview travel expenses for permanent positions. Information about these and other incentives is available in PERMISS. Army employment also offers attractive leave, insurance and retirement benefits, and typically provides a family friendly environment, meaningful public service work, and good opportunities for training and advancement based on merit. These are important tools in marketing the Army as an employer.

### **13-18. Evaluation of Employee Performance and Administration of Awards / Incentives Programs**

a. Administration of the evaluation and performance incentive functions of civilian personnel management requires managers and supervisors to exercise both leadership and fiscal responsibilities. It also requires an appreciation of the workplace environment and an understanding of individual needs for counseling, recognition, and reward. The civilian incentive awards program includes monetary and honorary awards. Civilian incentive award decorations and award approval authority are aligned with the military awards system to the extent practicable. The following Army civilian performance management programs are detailed in regulations, pamphlets, and DOD and OPM guidance listed in the reference section of this chapter.

(1) Performance planning and evaluation programs for ESPs, white-collar, blue-collar, and NAF employees.

(2) Base pay adjustment policy and procedures for all civilian employees (ESP pay increases; GS and FWS within-grade increases; and NAF pay increases).

(3) Cash and honorary award programs to recognize significant individual and group contributions (SES performance bonuses; GS, NAF, and FWS performance awards; GS quality step increases; and time-off and honorary awards).

(4) Policy and procedures for dealing with employees who fail to meet performance expectations.

(5) Personnel demonstration projects and ESPs use systems that reward high performance or contributions to mission, and place less emphasis on longevity for pay and retention.

b. As with the military performance evaluation systems, the civilian evaluation process is designed to enhance supervisory/employee communications and day-to-day relationships to improve overall performance. At the beginning of each rating period, the rating supervisor and the employee determine job requirements and develop a performance plan for the year. The performance plan should reflect the organization's mission and goals and the duties and responsibilities of the employee in concert with individual position descriptions. The performance plan may change during the year when the mission requires a re-ordering of responsibilities and priorities. At least once during the performance cycle (usually at the midpoint of the rating period) the rating official must conduct an in-progress review of employee performance. The in-progress review typically involves a discussion of employee

achievements, any changes to performance expectations and ways to improve performance. At the end of the rating period, the rating chain compares the individual's contributions to the requirements in the performance plan and renders a rating of record. The rating of record is used to make promotion/pay increase and training decisions, document justification for performance-based cash awards and honorary awards, and give additional credit for reduction-in-force/workforce shaping purposes. The evaluation process is also used to assist employees who experience performance problems. Performance counseling sessions may be used to help employees improve to an expected level or the evaluation can serve to support removal from the position if employees fail to meet standards. The keys to successful performance management are frequent, two-way communication and timely, appropriate action to either recognize significant contributions or correct performance which fails to meet expectations.

### **13-19. Training and Development of Employees**

On 10 December 2009, significant federal changes governing the training, supervisory, management, and executive development of employees went into effect. These changes were published by OPM in the federal register and they pertain to 5 CFR Parts 410 and 412 (Training; Supervisory, Management, and Executive Development). Based on these new requirements, the Army is developing and maintaining training programs to include training activities in support of organizational missions and to support the federal requirement to regularly evaluate Army training programs and plans with respect to accomplishing the agency's specific performance plans and strategic goals. Organizational managers and supervisors are required to develop, coordinate, and administer their training and development programs. Army executives, managers and supervisors are required to define their training requirements in support of the life cycle management of employee development through competency-based training.

a. **Training Programs.** Training categories cover from executive and management courses to adult basic education. Training is classified as either short or long-term (more than 120 days). The actual training may be delivered through on-the-job training at local activities, Army schools, DOD schools, CHRA locations, interagency schools, formal schools, and numerous government and non-government sources and online sources. Civilians may also compete for attendance in formal training programs such as Senior Service Colleges. The Army Regulation (AR) 215 series of documents establishes training requirements for both APF and NAF employees in MWR activities. This training is met largely through courses sponsored and/or conducted by the Installation Management Academy.

b. **Career Management System.**

(1) To establish basic policies and program requirements for the intake, assignment, training, and development of employees in designated occupations, the Army developed the Army Civilian Training, Education and Development System (ACTEDS) outlined in AR 690-950, Career Management. These systems support supervisors in recruiting candidates for long-term career opportunities and ensure a steady flow of capable, fully qualified, and trained employees for Army positions in 31 Civilian career professional, technical, and administrative fields.

(2) The career management system provides clear lines of progression leading to successively more responsible positions and a coordinated training and development program for occupational specialties, using both Army and outside facilities. Procedures are provided for counseling employees, planning individual development programs and appraising employee competencies. New employees participate in planned work or rotational assignments designed to develop technical and leadership competencies to prepare for future managerial responsibilities. The ACTEDS is the DA-wide program by which these objectives are accomplished and funded.

(3) At the higher-grade levels, typically for employees in positions graded GS-13 through GS-15, candidates are considered on an Army-wide basis. Application procedures depend on the particular career program.

(4) The above procedures apply to APF personnel, including those working in MWR programs.

### **13-20. Workers' Compensation Program**

a. **Appropriated Funds (AF)**

(1) Federal employees who are injured or become ill as a direct result of their employment are entitled by the Federal Employees Compensation Act (FECA) to medical care and salary replacement (compensation) while they are unable to work. Benefits are also available for a surviving spouse and dependents when the death is job related. Additionally, employees are entitled to a lump sum payment

when there is a permanent loss or impairment of a body part because of their employment. The Workers' Compensation program is costly to the Army, both in dollars and in lost human potential. The majority of the cost stems from workers who never return to Army employment and continue to draw a salary replacement for their lifetimes.

(2) To maintain control of these costs, each installation is required to have a FECA working group established by the Senior Commander, who chairs the group. The FECA working group will also include the Injury Compensation Specialist (ICS), representatives of management, medical, safety, and investigative service staff. The working group is required to meet at least quarterly to analyze trends and develop cost-containment initiatives. The ICS located in the CPAC has the lead in administering the workers' compensation program at the installation level. An employee who does not return to employment is entitled to salary replacement (compensation) for the employee's lifetime. The ICS and supervisor are responsible for ensuring questionable claims of injury or illness are challenged so the Army is not charged for undue expenses. The ICS should be in frequent contact with all injured employees and ensure each treating physician understands the Army is eager to offer light duty or modified employment.

(3) Managers and supervisors have several obligations in the FECA program:

(a) To ensure all workplaces are as safe as possible, employees are trained on safe work practices and issued appropriate safety equipment, and safety standards are constantly enforced. All workplace injuries and illness should be investigated by the supervisor and the safety office to ensure the cause of the injury or illness is corrected;

(b) To ensure employees are aware of reporting procedures, if injured;

(c) To advise employees of their right to seek medical care for the injury; and

(d) To work with the employee and ICS to adjust work assignments, in accordance with medical restrictions, in order to allow employees to return to work as soon as medically feasible.

b. Non-Appropriated Funds (NAF). NAF employees are entitled to worker's compensation benefits established under provisions of the Non-Appropriated Funds Instrumentalities (NAFI) Act of 1958 (5 USC Sections 8171-8173), which extends the provisions of the Longshore and Harbor Workers Compensation Act (LHWCA) (33 USC 901 et seq.). Worker's compensation provides benefits to NAF employees who are disabled because of job-related illness or injury or to the surviving spouse and authorized beneficiaries dependents in cases of death from job-related causes. Benefits apply to employees of NAFI/entities employed inside the continental United States or employees of NAFIs/entities who are U.S. citizens, permanent residents of the U.S. or a territory or possession of the U.S. and employed outside the continental U.S. (OCONUS). Benefits do not apply to active duty military personnel employed by NAFIs/entities or local Civilians employed by NAFIs/entities overseas. AR 215-3, Non-Appropriated Funds Personnel Policy and AR 215-1, Morale, Welfare, and Recreation Activities and Non-Appropriated Instrumentalities outline established processes and procedures related to Worker's Compensation for NAF employees.

### **13-21. Communication, Discipline, and Labor-Management Relations**

Supervisors are responsible for striving to develop a cooperative labor-management relationship: administering labor-management agreements; communicating management objectives, decisions, and viewpoints to their subordinates; and communicating their subordinates' views to higher-level management. Supervisors must analyze problems, develop solutions, and evaluate the results of decisions. The CPAC is responsible for assisting management in the day-to-day business of employee performance, discipline, individual adverse actions, effective use of recognition and awards, labor-management-employee relations, administration of leave and hours of work, and monitoring health and safety conditions.

a. If an employee believes his or her rights were denied or improper procedures were followed, or an action taken by management is unwarranted, he or she may use appropriate forums for relief. Such forums may include but are not limited to Administrative Grievance Procedures, Negotiated Grievance Procedures, Alternative Dispute Resolution (ADR), the MSPB, the Office of Special Council and EEO channels. Adverse actions may be appealed to the MSPB (except in cases of a short suspension defined

as 14 days or less). Short suspensions and reprimands may be contested through the Administrative Grievance System or Negotiated Grievance Procedures. Subsequently the courts may also be used.

b. The grievance procedures (both in policy and through negotiated agreements) specify steps to be followed for resolving employee dissatisfaction with aspects of working conditions, working relationships or employment status. Army policy encourages timely resolution at the lowest level practical; however, grievances may escalate up the chain of command, or, if under a negotiated grievance procedure, to binding arbitration.

c. Negotiated grievance procedures are outlined in labor contracts which are jointly developed by management and the local labor union granted exclusive recognition to represent all bargaining member employees (whether or not the employees are union members). The legal basis for the labor-management relations program for federal employees is 5 USC Chapter 71. It states that labor organizations and collective bargaining in the civil service are in the public interest. The rights and obligations of employees, unions and agency management are also established in AR 215-3 which provides the framework for addressing labor-management relations for NAF employees.

d. Supervisors are obliged to maintain a willingness to bargain collectively with labor organizations. Despite earnest efforts, there may be a time when an impasse will result, and if both parties fail to resolve their differences, the law provides for a neutral third party to resolve the impasse. This is the job of the Federal Mediation and Conciliation Service (FMCS) and the Federal Service Impasses Panel (FSIP). The FMCS assists the parties in reaching a voluntary agreement. Failing this, the FSIP may impose a settlement on the parties.

e. Management should strive to ensure non-adversarial labor-management relationships are nurtured so mission accomplishment is enhanced rather than inhibited by the labor relations process.

Management is also responsible for the following:

(1) Negotiating in good faith regarding conditions of employment (e.g., personnel policies, practices, and matters affecting working conditions).

(2) Furnishing official time to union representatives for negotiating collective-bargaining agreements and for other representational purposes as provided for by negotiated agreement.

(3) Deducting union dues from the pay of eligible employees who authorize such deductions and allotting those deductions to recognized unions.

(4) Notifying recognized unions and giving them the opportunity to be present at formal discussions between management and one or more employees.

(5) Allowing the union the opportunity to be represented at any examination of an employee pursuant to an investigation if the employee reasonably believes the examination may result in disciplinary action and if the employee requests representation (this is called the Weingarten Right).

f. Certain ground rules are established to safeguard the basic intent of the law. The FLRA is an independent, administrative agency presided over by three members appointed by the POTUS. The FLRA is the central policymaking body of the federal labor-management relations program. It decides representation questions (whether a union is eligible to represent certain groups of employees or whether particular employees fall within the certified bargaining unit), adjudicates negotiability disputes (whether there is an obligation to negotiate on specific proposals), adjudicates Unfair Labor Practices (ULP) (i.e., a violation of the provisions of Title VII) and decides appeals to arbitrators' awards.

g. Responsibilities of CPAC Directors. The CPAC Director is the designee of the installation/activity commander and, as head of the CPAC, is responsible for administering the civilian personnel program. Note that the commander retains overall responsibility for managing and leading the civilian work force. The CPAC director has responsibility for the implementation, maintenance, and evaluation of local personnel programs designed to assist supervisors with their personnel management responsibilities and achieve activity mission objectives. The CPAC Director interprets personnel policies and regulations and provides guidance and assistance in personnel matters in his or her assigned areas of responsibility. The CPAC Director must seek to ensure that management actions affecting civilian employees will enhance the Army's reputation as a good and fair employer, ensure employee productivity, support EEO and maintain effective community relations. The CPAC Director also has oversight of the local NAF personnel program. The CPAC director is assisted in the administration of the NAF discipline and labor relations programs by a NAF Human Relations Officer as well as the NAF personnel program in general.

h. Executive Order 13522. On December 9, 2009, President Obama signed EO 13522, Creating Labor-Management Forums to Improve Delivery of Government Services. Among other responsibilities, this EO

provides for establishing labor-management councils at the level of recognition and other appropriate levels agreed to by labor and management. Labor-management councils are intended to help identify problems and propose solutions to better serve the public and the agency mission. In addition to councils, the EO provides for employees and their union representatives to have pre-decisional involvement in all workplace matters to the fullest extent practicable. The CPAC can provide additional guidance and instruction on the local implementation of the provisions of EO 13522.

### **13-22. Army Civilian Wellness Program**

The Army's Civilian Wellness program helps employees enhance mental and physical well-being, prevent health problems, engage in health promoting behaviors and find assistance and support in times of need. Studies show that on average, employees who are healthy, and personally and professionally satisfied, are more productive, spend fewer days away from work due to illness, and are more engaged in their work. The Army's Wellness Vision statement is as follows: To improve the health and well-being of DA employees' lives through health education and activities that encourage and support positive lifestyle and healthy living changes thereby resulting in improved employee productivity and morale and healthcare cost savings for the Army. The wellness program is covered by AR 600-63, Army Health Promotion.

## **Section V Equal Employment Opportunity in the Army**

### **13-23. Equal Employment Opportunity and Diversity in the Army**

- a. Discrimination in the workplace negatively affects employee morale, productivity and teamwork, increases employee absenteeism and turnover and takes focus away from mission readiness.
- b. To ensure full implementation and intent of the law, the DA willfully complies with requirements set forth in, to include but not limited to, Title VII of the Civil Rights Act of 1964, as amended; 29 CFR Part 1614, The Rehabilitation Act of 1973 (as amended), Sections 501, 504, 508 of Title VI, The Equal Pay Act of 1963 (as amended), The Age Discrimination in Employment Act of 1967 (as amended), The Architectural Barriers Act of 1968 (as amended), The Genetic Information Nondiscrimination Act (GINA) 42 USC 2000, and all applicable implementing instructions from the DOD, the EEOC, and the OPM.
- c. DA policy is to provide equal opportunity in employment for all persons, to prohibit discrimination in employment because of race, color, religion, sex, national origin, age, disability, or genetic information, and to promote the full realization of EEO, diversity and inclusion principles in managing all human resources. No person shall be subject to retaliation for opposing any practice made unlawful or for participating in any stage of an administrative or judicial proceeding under these statutes.
- d. The EEOC has authority and oversight for the federal sector EEO program and provides federal agencies instruction and direction about how to obtain model EEO programs, practices and processes through affirmative employment planning models, identifying barriers that prevent employment and implementing strategies for diversity and inclusion. EEOC also provides for the EEO Complaint Process which encourages and enables opportunities to resolve allegations of employment discrimination quickly and administratively. The Army's authority to administer, manage and direct the Army's EEO & Diversity Programs is delegated to the Deputy Assistant Secretary of the Army for Diversity and Leadership (DASA DL).
- e. Within the Office of the DASA DL, the Policy and Programs Directorate is responsible for the administrative oversight of the Army's EEO and Diversity Program and is the proponent for AR 690-12.
- f. Responsibility for EEO, Affirmative Employment, Diversity, Inclusion, Education and Training programs extends from the Secretary of the Army to the ASA(M&RA), to the Deputy Assistant Secretary of the Army for Diversity and Leadership to commanders and leaders at all levels. The Army's EEO & Diversity Programs focus on evaluating and assessing Army workforce (civilian and military) demographics compared to appropriate labor force statistics, trends and/or barriers to employment and less than expected participation rates of groups in order to develop and implement strategies to address both internal training and development as well as external outreach to create a motivated talent pool capable of accomplishing the mission. The Army documents progress, strengths and weaknesses annually in the federal EEO Progress Report - Management Directive 715, The State of the Agency Briefing and through the administration of the 31 Army Career Programs.

g. The ASA(M&RA) serves as the Agency Director for EEO with responsibility for EEO, Diversity and EEO Compliance and Complaints Review/Adjudication Policy.

h. The DASA DL develops, directs and implements Army wide EEO, Diversity, EEO Compliance and Complaints policy and program evaluation and reporting requirements.

i. Commanders are responsible and accountable for effectively executing EEO programs and creating a climate where it is clear to Soldiers and civilians that unlawful discrimination and harassment (sexual/non-sexual) will not be tolerated. All allegations of discrimination will be dealt with seriously, swiftly and effectively in accordance with all applicable laws, regulations, and procedures. Commanders will sign EEO policy statements expressing support of Army EEO and diversity policy upon assumption of command and disseminate them annually. The Commander serves as the senior rater of the EEO Official in the performance evaluation and review process.

j. The EEO Official is a member of the Commander's personal/special staff. EEO Officials are a part of the management team, not an advocate for employees and serve as an advocate for leadership, federal civil rights, due process, employee's rights, the EEO complaints process, and strategic management of human capital. Army Commanders will maintain a reporting structure providing the EEO Official direct access to the Commander and senior leaders as a trusted and confidential advisor for effective management and resolution, reporting, compliance, efficiency, and resources for the EEO Program. The EEO Official and staff will be used as a valued partner/advisor on all matters in the management and implementation of the civilian human resources programs and decision making models and processes within the command.

### **13-24. The Equal Employment Opportunity Complaints Program and Process**

a. Within the office of the DASA DL, the Equal Employment Opportunity Compliance and Complaints Review (EEOCCR) Directorate is responsible for the administrative oversight of the Army's EEO Complaints Program, and is the proponent lead for AR 690-600, Equal Employment Opportunity Discrimination Complaints which implements the complaints program. DL-EEOCCR monitors the Army's compliance with laws, statutes, and regulations governing EEO complaint processing, reports the Army's compliance status to the EEOC annually, and is the complaint records custodian for the Army. DL-EEOCCR is also the Army's adjudicator of the merits of formal EEO complaints when final agency decisions are requested or required.

b. EEO offices generally have one of two roles: operational and administrative. Operational EEO offices are responsible for processing EEO complaints and providing training and information to the workforce. Many operational EEO offices are located on Army installations and provide services to tenant commands on the installations as well as their own commands. Administrative EEO offices are responsible for monitoring complaint activity within their area of responsibility but generally do not process EEO complaints themselves. Army Commands (ACOM), Army Service Component Commands (ASCC), and Direct Reporting Units (DRU) headquarters EEO offices are generally administrative. Some administrative EEO offices have oversight and support responsibilities for operational EEO offices.

c. On behalf of the Commander, the EEO Officer is charged with the duty to impartially execute the EEO Complaints Program and ensure due process is preserved. Commanders should be briefed on the status of current complaints within the command, the use of ADR, the timeliness of complaint processing, the office complaint load overall (if the EEO office processes complaints for tenant organizations as well as the command), and trends in complaints impacting the command. Other senior leaders should also be briefed on the status of complaints within their area of responsibility as appropriate.

d. The Complaints Process. Army employees, former employees, applicants for employment, and contractors who believe they have been discriminated against by the Army on the basis of race, color, national origin, religion, sex, age (40 and over), mental or physical disability, genetic information, or in reprisal or retaliation for having engaged in protected EEO activity have the right to initiate an EEO complaint with the Army. Examples of employment actions that may give rise to a complaint include, but are not limited to, hiring and promotion decisions, performance evaluations, reassignments, disciplinary actions, and harassment.

e. Individuals must contact the EEO office, or anyone reasonably connected to EEO, to initiate a precomplaint. Contact must be made within 45 calendar days from the date the individual knew or should have known about the alleged discrimination. An employee from the EEO office will conduct a precomplaint interview with the individual, called the aggrieved, and document the claim and the narrative



information. An EEO Counselor will be assigned to conduct a limited inquiry into the claims alleged. When deemed appropriate by the EEO officer, and after coordination with the Labor and Management Employee Relations (LMER) official, legal officials, and Army management, ADR may be offered to the aggrieved as a means of resolving the complaint. If resolution of the complaint is reached at any point in the process, the terms of the resolution will be documented in a written negotiated settlement agreement. Commanders and other senior leaders may promote ADR programs and encourage managers and supervisors in their organizations to participate in ADR. If the complaint cannot be resolved, the aggrieved will receive a Notice of Right to File a Formal Complaint of Discrimination, and will have 15 calendar days from the date of receipt of the notice to file a formal complaint.

f. Upon receipt of a written formal complaint, the EEO officer will determine whether the claim(s) alleged can be dismissed for procedural reasons provided in 29 CFR 1614 and AR 690-600. A claim(s) that cannot be dismissed will be accepted. The EEO officer will issue a letter accepting and/or dismissing claims identified in the complaint within 15 calendar days of receipt of the formal complaint. If a claim is accepted, a formal investigation is arranged and ADR may be offered again. The EEO office will request the assignment of an investigator from the DOD IRD. IRD charges a flat administrative processing fee for requests for investigators. The activity where the discrimination is alleged to have occurred is responsible for paying the IRD fee and identifying the activity Point of Contact (POC) who will make the payment. Once an investigator is assigned, the EEO office will coordinate the investigation. IRD investigations are conducted via Fact Finding Conference (FFC), the Army's preferred method of investigation. The FFC is attended by the investigator, the complainant and complainant's representative, and other responding management officials, witnesses, agency representatives, and a certified court reporter. Commanders and other senior leaders are required to ensure their organizations cooperate with any request from an EEO officer for documentation or the testimony of a Soldier or Civilian within the command identified as a witness. Testimony is taken under oath and on the record from the complainant, the responding management official, and other witnesses. The activity where the discrimination is alleged to have occurred is also responsible for paying for a certified court reporter to take a verbatim transcript of the investigation. The investigator will use the verbatim transcript and complaint documents to draft a Report of Investigation (ROI). The ROI is a compilation of facts and evidence taken under oath to be used to make a decision on the merits of the complaint at a later time. The Army is responsible for ensuring investigations are completed within 180 calendar days of the formal filing date or within 120 calendar days where the complaint involves an issue appealable to the MSPB. The investigation officially ends when the EEO office receives the ROI.

g. Once the EEO office receives the ROI, a copy is sent to the complainant, along with a Post-Investigative Options Notice. This notice provides the complainant the option of either requesting a hearing before an EEOC Administrative Judge (EEOC AJ) or requesting a Final Agency Decision (FAD) from the EEOCCR. If the complainant fails to select an option, the EEO office will request a FAD on the complainant's behalf. If the complaint involves an issue appealable to the MSPB, the complaint will be sent to the EEOCCR for a FAD. If the complainant elects to request a hearing, the hearing request, along with a copy of the complaint file, is sent to the appropriate EEOC regional or field office and the EEOC AJ is appointed to hear the complaint. Once the hearing is scheduled, witnesses will be required to attend and provide sworn testimony at the hearing. The activity where the discrimination is alleged to have occurred is also required to pay for the services of a court reporter to take a verbatim transcript of the hearing. After the hearing, the EEOC AJ will issue a decision stating whether discrimination was or was not found to have occurred. The EEOC AJ decision is forwarded to the Army (EEOCCR) for issuance of a Final Agency Action (FAA) implementing the AJ's decision. The complainant has the option of appealing a FAA or a FAD to the EEOC Office of Federal Operations (OFO) or filing suit in federal court. The Army may choose to appeal an EEOC AJ's finding of discrimination to the EEOC OFO instead of issuing a FAA.

h. Failure to cooperate with the complaint process places the Army at risk. A finder of fact, such as an EEOC AJ or EEOCCR, may determine the failure to cooperate constitutes sufficient grounds to presume unlawful discrimination occurred. This is called an adverse inference, and essentially means a prima facie case of discrimination is established and the agency bears the burden of providing evidence to rebut the adverse inference. When a finder of fact determines discrimination occurred, the activity where the discrimination occurred is responsible for providing the relief the complainant is deemed entitled to, such as funding monetary damages (including attorney fees), initiating personnel actions and conducting a

culpability study of management officials found to have discriminated to determine what, if any, disciplinary action(s) should be taken. A management official found to have discriminated against an employee may be subject to discipline, including termination in accordance with AR 690-700, Chapter 751 Table of Penalties. A finding of discrimination may also prevent a management official from being eligible for certain awards and prevent an officer from promotion into or up through the General Officer ranks.

### **Section VI** **Executive and Senior Professional Personnel (ESP)**

#### **13-25. Executive and Senior Professional Structure and Composition**

a. Civilian senior leadership is crucial to the support of military operations in a wide range of functions necessary for the Army to achieve battlefield success. This includes roles in procurement, logistics, research and development, finance, and human capital management. Executive and Senior Professional (ESP) positions are above the GS-15 level and salaries may range as they do for general officers. OPM establishes the regulations and allocations for ESP positions. DA requests allocations through OSD. Army's authorized ESP positions include a broad range of occupational series spanning across the U.S. and overseas. However, almost half of the Army's ESP positions are located in the Washington, DC Metro area.

b. On 9 August 2010, the SECARMY signed the Executive Resources Board (ERB) Charter. The ERB plays an active, robust role in formulating policies for and in the management, governance and oversight of Army ESP programs. The ERB also reviews and renders decisions or opinions on certain actions affecting ESP members and positions, including ESPs assigned to combatant commands (COCOM) to which the Army provides administrative and logistical support. The ERB advises the SECARMY on matters relating to the hiring, training and development, utilization, performance evaluation, and compensation of the Army's ESP workforce, which includes career SES, SL, ST, DISES, and DISL personnel. The ERB may also provide advice on, and oversight of, matters relating to other Army executive-level positions.

#### **13-26. Qualifications of Senior Executive Service Members**

a. There are five Executive Core Qualifications (ECQ) all potential SES members must demonstrate prior to selection. They are:

(1) **Leading Change.** This core qualification involves the ability to bring about strategic change, both within and outside the organization to meet organizational goals. Inherent to this ECQ is the ability to establish an organizational vision and to implement it in a continuously changing environment.

(2) **Leading People.** This core qualification involves the ability to lead people toward meeting the organization's vision, mission, and goals. Inherent to this ECQ is the ability to provide an inclusive workplace that fosters the development of others, facilitates cooperation and teamwork, and supports constructive resolution of conflicts.

(3) **Results Driven.** This core qualification involves the ability to meet organizational goals and customer expectations. Inherent to this ECQ is the ability to make decisions that produce high-quality results by applying technical knowledge, analyzing problems and calculating risks.

(4) **Business Acumen.** This core qualification involves the ability to manage human, financial and information resources strategically.

(5) **Building Coalitions.** This core qualification involves the ability to build coalitions internally and with other federal agencies, state and local governments, nonprofit and private sector organizations, foreign governments, or international organizations to achieve common goals.

b. The executive development of employees in positions graded GS-14 and 15 levels or equivalent is an important command responsibility. ESP members are expected to possess leadership competencies that parallel those of Army general officers. Therefore, attendance at a Senior Service College program is a highly desirable experience for Civilians who aspire to ESP positions. Appointment to the ESP marks achievement of the highest nonpolitical Civilian executive position. These positions are given protocol precedence equivalent to lieutenant general, major general or brigadier general.

c. For more information on ESP positions go to <http://www.opm.gov/ses/index.asp>.

**Section VII****Defense Civilian Intelligence Personnel System****13-27. Structure and Composition of the Defense Civilian Intelligence Personnel System (DCIPS)**

a. DCIPS employees are U.S. citizens paid from APFs. Unlike other APF civilians, they are managed through a statutorily based excepted personnel system administered by the OSD for the DOD Intelligence Community.

b. There are approximately 6,800 civilians in the Army under this personnel system. The Army includes in DCIPS all employees in series and specialties with clear ties to the intelligence arena wherever they hold positions. Some examples are intelligence specialists in the 132 series and intelligence assistants in the 134 series regardless of function as well as security specialists in the 080 series and security assistants in the 086 series where 51% or more of their duties are intelligence related (not law enforcement related). DCIPS coverage by series/function has resulted in most major commands having at least some DCIPS employees. The Army also includes in DCIPS all employees (except local nationals) in commands having a primary intelligence mission. Many of the administrative, technical, and support series, and a few wage grade employees in DCIPS, as well as the Army's intelligence and security professionals, are found in such commands as the U.S. Army Intelligence and Security Command (INSCOM).

**13-28. Relationship of Defense Civilian Intelligence Personnel System to the Army Civilian Personnel Program**

a. DCIPS is considered a part of the Army's overall civilian personnel program and has tested innovative personnel management features for the Army and the DOD. As a statutory alternative personnel system, DCIPS is exempt from Title VII job classification provisions and has adopted the use of the National Security Agency's (NSA) classification system to better align grades with the rest of the intelligence community. DCIPS is also exempt from many OPM hiring provisions and can directly consider applications from non-government employees through its own merit system. In 2009, DOD revised DCIPS to encompass all of DOD's intelligence community, not just the military services.

b. Civilian personnel service support for CONUS intelligence activities are consolidated at the Fort Huachuca CPAC and West Regional Processing Center at Fort Huachuca, Arizona. This consolidation improved HR understanding and system expertise and increased personnel service effectiveness and efficiency.

c. DCIPS was implemented in FY 1990, first as a tri-service system known as the Civilian Intelligence Personnel Management System (CIPMS), and then evolving into DCIPS when a provision of the DOD Authorization Act of 1997 (known as the DOD Civilian Intelligence Personnel Policy Act of 1996) combined all civilian personnel management systems for DOD intelligence components into one broad excepted service system. DCIPS legislation and supporting initiatives continually strive to achieve a broad common architecture of policies, systems and standards while protecting individual Service and agency prerogatives. DCIPS plans common employment and compensation architectures along with inter-community rotational and development programs. Common senior executive and leader programs have also been developed. These include the DISES for intelligence executives and the DISL program for senior experts in the Section VIII Civilian Expeditionary Workforce (CEW).

**13-29. Civilian Expeditionary Workforce**

a. DOD issued a new DOD Directive (DODD), 1404.10, DOD Civilian Expeditionary Workforce on 23 January 2009. This new directive reissued the previous DODD 1404.10, Emergency-Essential (E-E) DOD U.S. Citizen Civilian Employees (dated April 10, 1992) to establish the policy through which an appropriately sized subset of the DOD Civilian workforce is pre-identified to be organized, trained, and equipped in a way to facilitate using their capabilities for operational requirements. These requirements are for DOD civilians to assist military forces and are typically away from the normal work locations of DOD civilians or in locations and situations where other civilian employees may be evacuated. These employees are collectively known as the DOD Civilian Expeditionary Workforce. The DODD 1404.10 also superseded any conflicting portions of other DOD directives and guidance. Members of the DOD CEW are to be organized, trained, cleared, equipped, and ready to deploy in support of DOD military operations

to include combat operations, contingencies, emergency operations, humanitarian missions, disaster relief, restoration of order, drug interdictions, and stability operations in accordance with DODD 3000.05.

b. The DODD 1404.10 updates policies and responsibilities for designating part of the DOD CEW using the existing category of E-E civilian employee positions, and establishes policies and responsibilities for designating part of the DOD CEW using new categories of Non-Combat Essential (NCE) positions and Capability-Based Volunteer (CBV) employees and former DOD employees.

c. Force Integration. DOD integrated civilian workforce capabilities into its DOD Total Force planning processes. Civilian manpower requirements are sourced and designated consistent with the manpower policy and procedures in DOD Instruction 1100.22 (Policy and Procedures for Determining Workforce Mix). DOD CEW requirements are included in the DOD Global Force Management process.

d. Implementing the CEW program in the Army requires commands to identify and designate a portion of their workforce as CEW. Additionally, Commanders of major commands are responsible for ensuring all designated CEW employees are properly trained, equipped, and ready to deploy. This also includes ensuring employees returning from a deployment complete the required Post Deployment Health Assessments (e.g., 30 and 90 to 180 days after deployment). To aid Commanders in ensuring the readiness of their designated CEW employees Army employees are processed through the CONUS Replacement Center (CRC) located at Fort Bliss, Texas.

e. CEW Designations and Definitions.

(1) E-E Emergency Essential. Position-based designation to support the success of combat operations or the availability of combat-essential systems in accordance with USC section 1580 of Title 10 and designated as key.

(2) NCE Non Combat Essential. A position-based designation to support expeditionary requirements in other than combat or combat support situations and designated as key.

(3) CBV Capability Based Employee Volunteers. An employee who may be asked to volunteer for deployment, to remain behind after other civilians have evacuated, or to backfill other DOD civilians who have deployed to meet expeditionary requirements to support critical expeditionary requirements that may fall outside or within the scope of an individual's position.

(4) Capability-Based Former Employee Volunteer Corps. A collective group of former (including retired) DOD civilian employees who have agreed to be listed in a database as individuals who may be interested in returning to federal service as a time-limited employee to serve expeditionary requirements or who can backfill for those serving other expeditionary requirements.

(5) Key Employees. DOD civilian employees in positions designated as E-E and/or NCE are to be designated key in accordance with DODD 1200.7.

### Section VIII

#### Army Personnel Transformation

##### 13-30. Current and Transforming Civilian Human Resource Administration

The current CHR force is vital to the Army's mission. Each CPAC staff member is a strategic partner with serviced commands, managers and supervisors. Today, the Army faces significant challenges as it transforms to a more agile and technology-based force. The CHR community will use Lean Six Sigma methodology to redesign business processes and delivery services and reinvest those savings into the organization to continue providing world-class customer service.

##### 13-31. Career Management

In 2011, the Army undertook transformation initiatives to expand career program coverage to encompass 100% of its civilian population, both Appropriated and Non-Appropriated fund, except for National Guard Bureau technicians and indirect hire foreign nationals. Functional Chief (FC) and Functional Chief Representative (FCR) roles and responsibilities were expanded to exercise an evolving strategic and competency-based, life-cycle management planning environment and to address occupational and career program management matters across command lines.

## Civilian Expeditionary Workforce Model

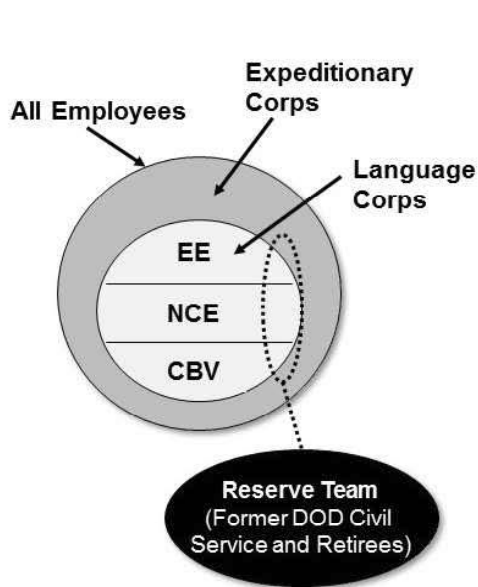

### Features:

- Designated subset of employees to respond within 72 hours to 30 days of notification
  - **EE—Emergency Essential:** a position-based designation to support combat operations or combat-essential systems in a combat zone (10 U.S.C. 1580). Deployability required as condition of employment
  - **NCE—Non-Combat Essential:** a position-based designation to support non combat missions. Deployability required as condition of employment
  - **CBV—Capability Based Employee Volunteers:** a personnel-based designation to support voluntary identification of capabilities outside scope of an employee's position for EE and NCE requirements
  - **Reserve Team—Inventory of Former or Retired DOD Employees:** prepared to support backfill or deployed requirements

Figure 13-2. Civilian Expeditionary Workforce Model

### 13-32. Hiring Reforms

Army's HR community will continue to support recruitment and hiring reform objectives developed to improve the quality and speed of the hiring process. In addition, these hiring reforms require managers and supervisors to assume a greater responsibility and accountability in the planning, recruitment and selection of the employees under them.

## Section IX

### Summary and References

#### 13-33. Summary

a. The purpose of the Army Civilian Personnel Management System is to provide a motivated and technically qualified work force to meet Army requirements. The civilian workforce is an integral part of the Army team. Army civilians play an important role in all Army missions and share in the Army's accomplishments. The Army employs civilians because they possess unique skills, ensure operational continuity, are economical and permit military personnel to perform military duties. The civilian personnel management system and its supporting policy and service organizations contribute significantly to the Army's overall mission.

b. More than half of Army civilian positions are bargaining unit positions represented by labor unions. Army leaders, both civilian and military, must accept their labor-management responsibilities. The efficiency of Army operations cannot be allowed to fail due to an unhealthy labor climate where leaders did not accept their obligations to advise, consult, and bargain as the law requires.

c. As the force downsized and underwent initiatives to convert formerly military positions to civilian occupancy, more civilians assumed key roles in headquarters and support activities, schools and training

centers, and BASOPS. For many of these important positions it may not be possible to hire people with the necessary skills. Therefore, the Army must develop civilians from within its current ranks.

d. This chapter provided a brief overview of the Civilian Personnel Management System to describe how the Army designed major processes to support Army leaders. It is important to understand the legal basis for the federal civil service, how the Army's system works within the federal system and also the regulatory basis and practices for the Army's NAF Personnel System. Furthermore, commanders and managers at all levels must have a clear understanding of the nature of the civilian personnel structure, programs, and mission, as well as their responsibilities to provide effective leadership and management. DA civilians are part of an Army team comprised of a diverse workforce dedicated to doing the best job possible to ensure the Army accomplishes its missions effectively. The Army and DOD civilian personnel web sites contain a great deal of helpful information accessible at <https://acpol.army.mil> and, respectively. The CSLMO secure web site is accessible by personnel holding an AKO registered CAC at <https://www.cslmo.army.mil>.

### 13-35. References

- a. 5 CFR Parts 410 and 412, Training; Supervisory, Management, and Executive Development.
- b. Age Discrimination in Employment Act of 1967.
- c. Americans with Disabilities Act of 1990.
- d. Architectural Barriers Act of 1968.
- e. Army Regulation 10-89, U.S. Army Civilian Personnel Evaluation Agency.
- f. Army Regulation 215-1, Morale, Welfare, and Recreation Activities and Non-Appropriated Fund Instrumentalities.
- g. Army Regulation 215-3, Non-Appropriated Funds Personnel Policy.
- h. Army Regulation 570-4, Manpower Management.
- i. Army Regulation 600-3, The Army Personnel Proponent System.
- j. Army Regulation 600-7, Nondiscrimination on the Basis of Disability in Programs and Activities Assisted or Conducted by the Department of the Army.
- k. Army Regulation 600-63, Army Health Promotion.
- l. Army Regulation 672-20, Incentive Awards.
- m. Army Regulation 690-11, Use and Management of Civilian Personnel in Support of Military Contingency Operations.
- n. Army Regulation 690-12, Equal Employment Opportunity Program and Affirmative Action.
- o. Army Regulation 690-13, CIPMS - Policies and Procedures.
- p. Army Regulation 690-400, Chap 432, Reduction in Grade and Removal Based on Unacceptable Performance.
- q. Army Regulation 690-400, Chap 4302, Total Army Performance Evaluation System (TAPES).
- r. Army Regulation 690-600, Equal Employment Opportunity Discrimination Complaints.
- s. Army Regulation 690-700, Chap 751, Discipline.
- t. Army Regulation 690-900, Chap 920, Senior Executive Service.
- u. Army Regulation 690-950, Career Management.
- v. Civil Rights Act of 1991.
- w. Civil Service Reform Act of 1978.
- x. DA Pamphlet 672-20, Incentive Awards Handbook.
- y. DA Pamphlet 690-11, Guide to Civilian Personnel Management.
- z. DA Pamphlet 690-46, Mentoring for Civilian Members of the Force.
- aa. DA Pamphlet 690-47, DA Civilian Employees Deployment Guide.
- bb. DOD Civilian Intelligence Personnel Policy Act of 1996.
- cc. DOD Authorization Act of 1997.
- dd. DOD Manual 1400.25 Subchapter 920, Executive and Senior Professional Pay and Performance.
- ee. DOD 1400.25-M, Civilian Personnel Manual.
- ff. DOD 1404.10, DOD Civilian Expeditionary Workforce.
- gg. DOD Instruction (DODI), 1400-25, DOD Civilian Personnel Management Systems: Volume 250, Civilian Strategic Human Capital Planning (SHCP).
- hh. Equal Employment Opportunity (EEO) Act of 1972.
  - ii. Equal Employment Opportunity Commission Management Directive 715 (EEOC MD 715).

- jj. Equal Pay Act of 1963.
- kk. Executive Order 9830, Amending the Civil Service Rules and providing for Federal personnel administration.
- ll. Executive Order 12721, Eligibility of Overseas Employees for Noncompetitive Appointments.
- mm. Executive Order 13473, To Authorize Certain Noncompetitive Appointments in the Civil Service for Spouses of Certain Members of the Armed Forces.
- nn. Executive Order 13522, Creating Labor-Management Forums to Improve Delivery of Government Services.
- oo. Executive Order 13562, Recruiting and Hiring Students and Recent Graduates.
- pp. Federal Anti-Discrimination and Retaliation Act of 2002.
- qq. Genetic Information Nondiscrimination Act of 2008.
- rr. Hatch Act of 1939.
- ss. HQDA General Orders No. 3, 9 July 2002, and amendment No. 2002-03.
- tt. Longshore and Harbor Worker's Compensation Act (33 USC, 901 et seq.).
- uu. Management Directive 715 State of the Agency Report.
- vv. Non-Appropriated Fund Instrumentalities Act of 1958 (5 USC, Sec 8171 – 8173).
- ww. Rehabilitation Act of 1973.
- xx. Title 5 USC, Government Organizations and Employees.
- yy. Title 10 USC, Section 1580: Emergency Essential Employees: Designation.
- zz. Title 33 USC, Navigable Waters.
- aaa. Uniformed Services Employment & Reemployment Rights Act of 1994.
- bbb. Whistleblower Protection Act of 1989.

**This page is intentionally left blank**



## Chapter 14

### Training and Leader Development

#### Section I

##### Introduction

#### 14-1. Chapter Contents

a. This chapter covers Army training and leader development. Included are descriptions of the Army training domains, organizations, governance, support systems, management, policy, requirements, and munitions.

b. This chapter details operational and institutional training, individual and collective training, and unit training. It complements the Military and Civilian Resource Management chapters of this publication by further describing how training, education, and leader development are tailored for Army officers, warrant officers (WO), non-commissioned officers (NCO), Civilians, and Soldiers.

c. Army Regulation 350-1 prescribes policies, procedures, and responsibilities for developing, managing, and conducting Army training and leader development.

#### Section II

##### Strategic Training Framework

#### 14-2. Overview

The 39<sup>th</sup> CSA's Initial Message to the Army and the Secretary of the Army's Training Directive (Building Training Readiness) dated 11 FEB 16, drive the Army's Training Vision and Training Strategic Ends. The Army employs an ends, ways and means construct. Ends are the training objectives or what is to be accomplished, ways are courses of action / strategic concepts to achieve the strategic ends, and means include specific resources necessary for applying the concepts and achieving the Army's training objectives.

#### 14-3. Army Vision and Strategic Ends

The Army Vision (AV) is "Strategic Advantage in a Complex World." The 39<sup>th</sup> CSA's strategic priorities published in his Initial Message to the Army describe three readiness priorities for the Army: Readiness, Future Army, and Take Care of the Troops. The CSA describes Readiness as the #1 priority - our fundamental task. Training is the key component of readiness; therefore, all training must contribute to that end.

#### 14-4. Army Training Strategic Ends

a. Army Training directly supports the Army's Vision. Training applies across the Total Force—all components—for an Army that is fully-trained, capable, and ready to achieve the AV. The Army's intent is to develop trusted professionals of character who demonstrate the required leader attributes and competencies, and to prepare leaders who can exercise mission command (MC) to succeed at any assigned mission as part of a trusted team. This will be accomplished through leader development as a shared responsibility between the institutional Army (education or training institutions), the operational force (OF) (organizations or units), and the individual. The operational Army and the institutional Army work together to ensure synergy in support of combatant commanders (CCDR).

b. Army Training Strategic Ends: A Ready (Trained) Army.

(1) Train the Total Force to rapidly deploy, fight, sustain itself, and win against complex state and non-state threats in complex environments (e.g., the expeditionary mindset).

## HOW THE ARMY RUNS

(2) Train to ensure the right mix of operationally ready and responsive forces and capabilities to rapidly meet emergent combatant command (CCMD) requirements while maintaining an operational and strategic reserve.

(3) Train to rebuild the Army's combined arms maneuver (CAM) core competency and to maintain wide area security (WAS) and special operations core competencies by employing combat training centers (CTC) to challenge Army formations. Train to conduct unified land operations (ULO) executed through decisive action by means of all seven Army core competencies, guided by MC in a realistic training environment against a hybrid threat stressing unified action partners and Special Operations Force (SOF) / conventional force (CF) interdependence.

ENDS	WAYS	MEANS
<p><i>Operationalize...</i></p> <p><b>CSA Priorities</b></p> <ul style="list-style-type: none"> <li>- Readiness (Current Fight)</li> <li>- Future Army (Future Fight)</li> <li>- Take care of the Troops (Always)</li> </ul>	<p><b>Institutional Training</b></p> <p>(IMT, MOS-T, Functional, PME, Weapons Qual, APFT, Gender-Neutral, Warrior Tasks)</p>	<ul style="list-style-type: none"> <li>• Doctrine</li> <li>• Policy</li> <li>• Training Guidance</li> <li>• Time</li> <li>• Facilities</li> <li>• Ranges</li> <li>• Ammo</li> <li>• Equipment</li> <li>• Simulators</li> <li>• Instructors</li> <li>• Training Areas</li> <li>• Sustainable Readiness</li> <li>• Objective –T</li> <li>• Army Training Network</li> <li>• CATS</li> <li>• METL</li> <li>• STRAC</li> <li>• POM/Budget</li> </ul>
<p><i>In support of...</i></p> <p><b>Unified Action</b></p>	<p><b>Home station Training</b></p> <p>(Individual and Collective: STX, FTX, LFX, FCX, CPX, Weapons Training, APFT, Individual/Crew, Warrior Tasks and Battle Drills)</p>	
<p><i>Through...</i></p> <p><b>Unified Land Operations</b></p> <p>Army forces trained and ready to rapidly deploy to fight and win against hybrid threats, contributing capabilities as part of the Joint Force in support of Unified Action</p>	<p><b>Combat Training Center Program</b></p> <p>(Maneuver and MCTP, CTC, WFX, XCTC, CSTX, External Evaluation, EDRE, Train with SOF, High-Intensity Focus with Cyber, Train Multi-Compo, Sustain COIN)</p>	
<p><i>By training to achieve...</i></p> <p><b>Readiness Objectives: Army Capabilities and Capacity</b></p> <ul style="list-style-type: none"> <li>• Expeditionary</li> <li>• Mobilization</li> <li>• Set the Theater</li> <li>• Decisive Action</li> <li>• Regeneration</li> <li>• Army support to other Services</li> <li>• Other unique Army capabilities (CWMD, Special Operations, Ballistic Missile Def, Cyberspace ops)</li> </ul>	<p><b>Joint and Army Exercise Program</b></p> <p>(EDRE/SEDRE, WFX, Joint &amp; Combined Arms Maneuver, Theater Security Cooperation, Pacific Pathways, ERI, COCOM Exercises, BMD, Cyber)</p>	
<p>Operational Force, Operational Depth, Strategic Depth</p> <p><b>"Readiness for ground combat is – and will remain – the U.S. Army's #1 priority" CSA 39</b></p>		

**Figure 14-1. Army Training Ends, Ways, and Means**

(4) Conduct tough, realistic multi-echelon home station training using the integrated training environment (ITE) consisting of live, virtual, gaming and constructive capabilities fielded by the Army's training support system (TSS) to replicate high fidelity, complex operational environments (OE) in order to develop agile and adaptive leaders and versatile units.

(5) Train to leverage multi-echelon joint and multinational command post exercises (CPX), staff rides, simulations, and the MC Training Program (MCTP) to produce a regionally capable Joint Force Land Component Commander (JFLCC) and Joint Task Force (JTF) headquarters.

(6) Ensure that Army units are trained and prepared for current, emerging, and evolving missions in areas such as homeland defense (HD), Defense Support of Civil Authorities (DSCA), space, cyberspace, missile defense, countering weapons of mass destruction (CWMD), and weapons of mass destruction-elimination (WMD-E).

(7) Leverage the expertise and competency of our Department of the Army Civilian (DAC) component. This is key and essential to the success of our Soldiers on the battlefield and to building a flexible, streamlined and responsive global force.

(8) Reinforce Army values and ethical leadership throughout all unit and institutional training, leader development programs, and professional military education (PME).

(9) Educate and develop all Soldiers and civilians to grow the intellectual capacity to understand the complex contemporary security environment to better lead Army, JIIM task forces, and teams.

(10) Open previously closed positions and occupational specialties to women while maintaining our combat effectiveness. The initiative seeks to remove as many barriers as possible and allow talented people, regardless of gender, to serve in any position they are capable of performing to standard.

## 14-5. The Training Challenge

The Army's training challenge is to optimize, synchronize and support training in schools, training and education in units, and self-development training to produce forces and leaders capable of responding across the range of military operations. Internal to unit training, the greatest challenge is managing the broad array of commander responsibilities and requirements in relation to the time available to train and conduct unit activities resulting in overall unit readiness. Prioritization of activities and requirements is imperative. Army Doctrine Publication (ADP) 7-0, Army Doctrine Resource Publication (ADRP) 7-0 and Field Manual (FM) 7-0 provide the Army's doctrinal foundation for how units train to build training readiness. Unit Combined Arms Training Strategies (CATS) are Mission Essential Task List (METL) - based training strategies which support readiness reporting requirements. They are designed to train a unit to perform its missions, employment, capabilities and functions and contain all the collective tasks designed to train the unit. Training events in the CATS provide recommendations of the methods that can be employed to train those tasks. Training events are often designed to suggest a progressive training path so that commanders can select the appropriate level of event difficulty to match the unit's level of proficiency at executing the collective tasks associated with that task set. CATS are nested crew-level to brigade combat team (BCT) or functional/multi-functional brigade, and corps, integrate DA Pam 350-38 and provide recommendations on who, what, how and the frequency to train. They provide recommendations on use of training aids, devices, simulators, and simulations (TADSS), training gates, multi-echelon training, resources and provide a base line purpose, outcome and execution guidance for each event. A unit commander has two major training responsibilities: prepare the unit to accomplish the as designed or assigned mission and develop Soldiers/leaders for future responsibilities. The commander will use METL-based CATS to prepare the unit to perform those missions the unit was doctrinally designed to execute across the range of military operations. Assignment of a deployment mission allows leaders, in dialogue with their higher headquarters commander and with guidance from the ASCC commander, to focus their training on those METL tasks that support the deployment mission. The process for METL task development for emerging tasks and assigned missions can be found in FM 7-0.

## Section III Operational Training

### 14-6. Training by Operational Units

Training prepares forces to conduct operations as doctrinally designed, or for an assigned mission. Training develops the teamwork, trust, and mutual understanding that commanders need to exercise MC and that forces need to achieve unity of effort. Training does not stop when a unit deploys. If the unit is not conducting operations or recovering from operations, it is preparing for future operations.

### 14-7. Leader Responsibility

Leaders are responsible for the readiness of their units and the training to accomplish it. The operational domain encompasses training activities executed by operational units, whether by the entire unit, by sub-elements of the unit, or for leaders and individuals at the unit. These activities include: training conducted by unit leaders at home station and other regional / national / international training areas / facilities; training conducted for the unit at Army-sponsored training venues like CTC rotations, Army National Guard (ARNG) exportable combat training capability (XCTC) lanes, and U.S. Army Reserve

(USAR) combat support training exercises (CSTX); and training exercises (e.g., multinational, joint, and/or service-sponsored exercises) executed by the unit.

### 14-8. Force Generation

a. Globally Responsive Army. The Army must create and sustain a ready and capable Total Army that provides joint and combined forces with expeditionary and enduring land power for the range of military operations. This globally responsive Army will feature unique competencies such as operational leadership, mobility, command and control (C2), and theater logistics at all echelons. It will also rapidly deploy, fight, and win whenever and wherever the Nation's interests are threatened. The globally responsive Army will maintain a responsive force posture and effective network of installations and capabilities at home and abroad to protect U.S. interests and those of its Allies, while aggressively pursuing improvements to deployment processes to eliminate institutional impediments and expediting movement of ready forces in response to Geographic Combatant Command (GCC) requirements. Finally, the Global Response Force (GRF) will support the joint force with critical enablers such as aviation, intelligence, engineers, logistics, medical, signal, and special operations, both while en route to, and operating within, expeditionary environments alongside unified action partners.

b. Regional Alignment. Army forces may be aligned with a GCC. Regional alignment provides deployable and scalable, regionally-focused Army forces, that are task-organized for direct support of geographic and functional CCDR and joint requirements. A regionally engaged Army shapes and sets theaters for regional commanders while employing unique Total Army characteristics and capabilities to influence the security environment, build trust, develop relationships, and gain access through rotational forces, multilateral exercises, military-to-military engagements, coalition training, and other opportunities. A regionally engaged Army assures the readiness of forward deployed and rotational forces in support of defense strategy, and deepens regional understanding of Soldiers, leaders, and units to sharpen tactical, operational and strategic planning and operations. Finally, regional alignment improves Special Operations Force (SOF)-Coalition Force (CF) interdependence and integration in pursuit of a Prevent-Shape-Win strategy. Regionally Aligned Forces (RAF) training is often augmented with CCDR-specific training requirements, and includes cultural, regional, and language (CREL) training.

c. Force Generation Process. The Army uses a deliberate process to meet operational requirements for Army forces. U.S. Army Forces Command (USFORSCOM) manages force generation for the Army and ensures mission requirements are assigned to unit(s), ensures unit(s) understands Army / theater / mission requirements, and ensures units have training support needed to prepare for mission success (e.g., a scheduled CTC rotation).

d. Sustainable Readiness. (SR) is the Army's force generation concept adapted to the needs of a contingency force that is globally responsive and regionally engaged. SR sustains optimized levels of readiness throughout the Total Force; eliminates the "readiness cliff" common to units under ARFORGEN to: Normalize manning; synchronize equipping & modernization milestones with operational requirements; assess the Army's ability to satisfy *both* current Global Force Management Plan (GFMAP) requirements as well as War Plan demands; provide Army leaders with appropriate mitigation strategies consistent with available resources; operationalize the Reserve Component (RC); leverage the unique capabilities of ARNG and USAR forces to support early and mid-deploying forces; extend the Army's planning timeline by analyzing our ability to meet requirements four years into the future; and synchronize readiness resource decisions with POM development.

e. Objective T (OBJ-T) establishes an objective baseline standard for the Army (RA, ARNG, USAR). It establishes objective task evaluation criteria for task proficiency that create higher confidence across the Army. It better defines T-level readiness and establishes clear links between mission essential task proficiency, individual and crew-served qualification, and collective live fire proficiency. OBJ-T reinforces and enables Unit Training Management. It increases understanding and use of training management doctrine by focusing on "how-to" manuals and content, beginning with FM 7-0 (Training to win in a complex world). OBJ-T also re-establishes an Army task framework that is hierarchical, includes all unit types and echelons, and allows for clear task cross-walks from individual through higher level collective tasks. It re-invigorates a common understanding of training-to-standard through improved Training and Evaluation Outlines. OBJ-T improves stewardship and optimizes training resources, establishing links between training activities, their cost, and the readiness generated.

## 14-9. Planning and Conducting Training in Units

- a. Unit leaders plan and conduct training in accordance Army training management doctrine.
- b. Army Doctrine Reference Publication (ADRP) 7-0, *Training Units and Developing Leaders*, expands on the foundations and tenants found in Army Doctrine Publication (ADP) 7-0. The most significant change from the 2011 edition of Field Manual (FM) 7-0, *Training Units and Developing Leaders for Full Spectrum Operations*, is the inclusion of the operations process as the accepted model for planning not only operations, but also unit training and leader development. The ADRP rescinds the idea that a separate and distinct training management process exists from the operations process for training and leader development. Such earlier concepts as long-range planning and short-range planning are now based on the military decision-making process and troop leading procedures as defined by ADRP 5-0, *The Operations Process*, and Army Tactics, Techniques, and Procedures (ATTP) 5-0.1. Both ADP 7-0 and ADRP 7-0 support the idea that training a unit is not fundamentally different from preparing a unit for an operation. Learning the concepts, ideas, and terminology of the operations process as units train makes the transition from training to operations a more seamless effort for both leaders and their units.

## 14-10. Troop Schools

Troop Schools help to support training execution and training management at the command or Army installation level. Commanders will use Troop Schools as part of their unit training strategy to acquire, enhance, sustain, and supplement individual military skills or pre-command education not readily available through the institutional training base. Soldiers should acquire these military skills early enough in the unit's force generation cycle to optimize their contribution to the unit. These military skills include but are not limited to Air Assault Operations, Arms Room Security, Mine Resistant Ambush Protected Vehicle Tactical Driving, Air Load Planning, Company Commander First Sergeant Course, etc.

## 14-11. Army Support of Unit Training

- a. Army Training Management System (ATMS). Units record and manage training using the web based resources provided by ATMS, which is comprised of the Army Training Network (ATN), the Combined Arms Training Strategies (CATS) development tool, and the Digital Training Management System (DTMS).
- b. ATN provides units with access to online Army training doctrine, products, techniques and downloadable resources. ATN is accessed at: <https://atn.army.mil>.
- c. Combined Arms Training Strategy (CATS). CATS are developed for company-level and higher table of organization and equipment (TOE) units and for identified Functional Capabilities (Stability, Mission Command, etc.). CATS provide a task based, event driven strategy that identifies a progressive sequence of training events that can be used by the unit to develop a Unit Training Plan (UTP) to train either for their unit capabilities as reflected by their HQDA Standardized mission-essential task list (METL) (see FM 7-0), or for an assigned mission. Training events in CATS range from individual, crew, and squad levels through company, battalion, brigade, division and corps levels, and provide a crawl, walk, run methodology to enable a unit to progressively build higher levels of readiness on tasks the unit is doctrinally designed to perform. CATS provide recommendations on methods that can be employed to train tasks in events using Live, Virtual, or Constructive training environments. CATS are nested crew- to brigade combat team (BCT)-level, integrate the weapons training strategies listed in DA Pam 350-38, *Standards in Training Commission*, and provide recommendations on who, what, how, and when to train. CATS also provide recommendations on use of Training Aids, Devices, Simulators, and Simulations (TADSS), training gates, multi-echelon training, resources, and provide a base-line purpose, outcome, and execution guidance for each event. CATS provide a strategy from which leaders can develop a UTP to develop mission-essential task proficiency for readiness reporting.
- d. DTMS. DTMS provides support for the doctrinal training processes described in ADP/ADRP/FM 7-0. DTMS allows unit leaders to view their unit's HQDA standardized METL. DTMS is designed to assist unit leaders to plan training and record task proficiency in the individual training record (ITR) and unit training record (UTR). The ITR records an individual Soldiers accomplishment of training conducted to include records of HQDA mandatory training, and other records of training governed by AR 350-1, Army Training and Leader Development. The UTR consists of unit-level accomplishment of training conducted. Commanders use DTMS to continuously assess unit training performance in order to improve task proficiencies.

### 14-12. Army Training Models

a. Army Training Models are a family of interrelated models that support the planning, programming and budgeting system. Currently there are three primary models: Training Resource Model (TRM), Aviation Training Resource Model (ATRM), and Institutional Training Resource Model (ITRM). These models provide the basis for training resource requirements development for Headquarters, Department of the Army (HQDA) and provide rapid adjustment / assessment of changing Army inputs (e.g., force structure, training strategies, MTOE authorized equipment, cost factors, student loads, etc.). TRM, ATRM, and ITRM have been designated as authoritative data sources. The Training Resource Management Information System (TRMIS) is a web-based tool that pulls together output from TRM, ATRM, and ITRM to provide ARSTAF and Army commands with access to training resource information.

b. The Cost of Training Readiness (COTR) Program is an Army initiative to capture costs and measure unit readiness generated using Objective T-rating standards. The Army must be able to optimally fund units and activities needed to achieve readiness objectives. The data analysis reflects what events were executed, the density and usage of the vehicles for each training event, the readiness generated against Objective T-rating standard, and the costs associated with the unit training. Results are fed back into the training resource models to synchronize funding to readiness objectives specified for all unit types in the sustainable readiness force generation process.

### 14-13. Combat Training Centers

a. Vision. The Army's Combat Training Center (CTC) Program remains the cornerstone of an integrated strategy that builds trained and proficient, combat-ready units and leaders to conduct operations as part of the Joint Force – ready to Win in a Complex World. CTCs provide a crucible experience for units and leaders training in a complex and highly realistic Decisive Action environment designed to replicate combat by stressing every Warfighting Function with operations against tough, free-thinking, realistic hybrid threats under the most difficult conditions possible. The CTCs will accelerate a return to standards-based training and the pace of the Army's transition to Unified Land Operations by challenging units and leaders to adapt to battlefield conditions, and by enhancing lethality and our ability to operate with our Unified Action Partners and Special Operations Forces across the range of military operations. The end state will be units and leaders are prepared to deploy worldwide, fight with confidence, and win against any adversary, anytime, under any conditions.

b. Program Objectives. The CTC program objectives are to: increase unit readiness; develop battlefield leaders; embed doctrine; provide feedback on unit tactical effectiveness to participants; and provide data to improve DOTMLPF-P input to the combat and training development processes. AR 350-50, *The CTC Program*, establishes Army policies for the management of the CTC program. The CTC program provides realistic joint and combined arms training in accordance with Army and joint doctrine, and approximates actual combat. The CTC program:

(1) Focus on a mission-essential task list (METL) with training for combat operations as part of the Joint team.

(2) Train for unified land operations and decisive action missions including: offense, defense, stability, and defense support of civil authorities.

(3) Stress realistic, sustained, multi-echelon, and fully integrated collective Unified Land Operations training for brigade combat teams (BCTs) and enablers, Theater Support Commands (TSCs), Expeditionary Support Commands (ESCs), sustainment brigades, functional and multi-functional support brigades, Special Operations Forces; division, corps and Army service component commands (ASCCs) as operational Army, Joint Force Land Component Commands (JFLCC), or Joint Task Force (JTF) capable headquarters.

(4) Focus on performance-oriented training in a Decisive Action Training Environment (DATE) based scenario assessed against established tasks, conditions, and standards.

(5) Support achieving and sustaining leader development and unit warfighting readiness using a combination of integrated live, virtual, and constructive (LVC) simulations.

(6) Facilitate commanders' readiness assessment through live-fire, force-on-force, and computer-simulated exercises that integrate all aspects of lethal and nonlethal effects, tailored to the operational environment from platoon to corps- level and that are based on unit warfighting focus within CTC capabilities.

(7) Include instrumented urban operations (UO) training experience during the rotation.

(8) Incorporate reception, staging, onward movement, and integration (RSOI) operations, regeneration, and deployment training.

(9) Fully integrate decisive actions including small scale chemical weapons of mass destruction injects incorporating SOF/CF handover coordination.

(10) Execute mission rehearsal exercises (MREs) for brigades and below and mission readiness exercises (MRXs) for divisions and above, as required.

(11) Conduct training as a multi-component team, implementing Total Army Force Policy by incorporating Active Army, Army National Guard, and United States Army Reserve Soldiers, leaders, and units at every echelon and opportunity.

c. Rigor. During a CTC experience, commanders will train with the equipment they would expect to take to war, to the extent possible. In order to provide a realistic training environment, each CTC will—

(1) Provide a DATE environment in which rotational unit commanders can train to established standards (for example, METL, Combined Arms Training Strategy, and approved training guidance).

(2) Capture Operational Environment (OE) complexities within various OE assessments to replicate (not duplicate) the OE of the theater to which the unit will likely deploy.

(3) Conduct doctrinally based after action reviews (AARs) focused on observed performance that enables Soldiers and leaders to discover for themselves what happened, why it happened, and how to sustain strengths and overcome weaknesses.

(4) Stress all warfighting functions in decisive air-ground unified land operations where both lethal and nonlethal solutions could be employed.

(5) Provide a freethinking, capabilities-based, opposing force (OPFOR) with an equal chance to win.

(6) Develop tactical or operational level of war scenarios where the outcome is not assured and that promote initiative-oriented warfighting skills for commanders.

(7) Ensure consequences of military decision making are allowed to fully develop in order to show cause and effect.

(8) Dedicate a portion of the rotation to retraining those tasks which the commander deems essential for their unit to increase proficiency. (Retraining is not an indication of failure).

(9) Execute training in compliance with applicable safety regulations, sustainability/environmental regulations (for example, AR 385–10, AR 385–63, AR 200-1, DA Pam 385–30).

d. Combat Training Centers. The CTC Program includes the Mission Command Training Program (MCTP); Joint Multinational Readiness Center (JMRC); Joint Readiness Training Center (JRTC); and the National Training Center (NTC). JMRC, JRTC, and NTC are collectively referred to as the maneuver CTCs (MCTCs) or dirt CTC sites.

(1) The MCTP, located at Fort Leavenworth, KS, is the Army's primary CTC for mission command training using constructive simulations as portrayed by a professional OPFOR. MCTP supports Army unit readiness, force generation processes, mission preparation progression, and other Army requirements. MCTP conducts or supports training that simulates unified land operations in the Operational environment (OE) at worldwide locations. The MCTP provides training events for National Guard BCTs, multifunctional support brigades, functional support brigades, Expeditionary Support Commands (ESCs), divisions, Theater Support Commands (TSCs), corps, ASCCs, Special Operations Joint Task Forces, Combined Joint Special Operations Task Force, and JFLCCs. MCTP provides training in coordination with Joint Staff J7 to commands and/or staffs that are designated to serve as a JTF. The MCTP creates training experiences that enable the Army's senior mission commanders to develop current, relevant, and campaign-quality, Joint and expeditionary mission command instincts and skills.

(2) The JMRC in a forward deployed environment at Hohenfels and Grafenwoehr, Germany, trains BCTs by conducting force-on-force and live-fire training in a joint scenario across the range of conflict, using an LVC training model, as portrayed by a professional OPFOR and controlled by an expert and experienced JMRC operations group (OPS GRP). Training occurs under tough, realistic, combat-like conditions across a wide range of likely tactical operations and MREs capable of full integration into higher-level exercises and scenarios. In support of Army unit readiness and force generation processes, JMRC will normally focus on collective training events supporting USAREUR BCTs. JMRC conducts one CTC Program BCT rotation per year, with the ability to surge to four rotations per year, at the Hohenfels-Grafenwoehr complex and associated maneuver rights areas. When directed, JMRC also supports non-CTC Program events, such as NATO Response Force (NRF), European Rotational Force (ERF) and Regionally Aligned Force (RAF) training using theater supplied assets and funding while leveraging CTC

facilities and ITADSS when appropriate. Use of the CTC facilities and ITADSS for non-CTC events will include theater reimbursement for any sustainment or repair costs.

(3) JRTC at Fort Polk, LA and NTC at Fort Irwin, CA train Army BCTs by conducting force-on-force and live-fire training in a Joint scenario across the range of conflict using a Live, virtual and constructive (LVC) training model as portrayed by a professional OPFOR and controlled by an expert and experienced OPS GRP. Training occurs under tough, realistic, combat-like conditions across a wide range of likely tactical operations and MREs capable of full integration into higher-level exercises and scenarios. In support of Army unit readiness and force generation processes, JRTC and NTC will normally focus on collective training events supporting BCTs achieving decisive action proficiency. However, JRTC and NTC may also be tasked to execute focused rotations in support of BCT mission preparation progression when required by Global Force Management allocation demands.

**14-14. Chief of Staff, Army Combat Training Center Huddle**

a. The CSA convenes a semi-annual CTC Huddle to discuss and decide CTC Program issues with a select group of Army senior leaders including the Vice Chief of Staff; Director of the Army Staff, Sergeant Major of the Army, the DA G-3/5/7; FORSCOM CG; USAREUR CG; TRADOC CG; the Army Material Command CG; the Chief of the Army Reserve; the Director, Army National Guard; CG, USASOC; CG CAC and DCG, CAC-T; CG 7th ATC; CG JRTC; CG NTC; Commander MCTP; DA G-3 Director of Training (DOT); and Director, Combat Training Center Directorate. Other leaders are involved as needed.

b. The HQDA G-3/5/7 Director of Training is the lead office for scheduling, agenda development, meeting preparation, execution, and coordinating the official record of the CTC Huddle. The CTC Directorate supports the DOT in all of these activities. The four-hour huddle is normally scheduled in conjunction with another senior leader event (4-Star Conference, Army Training and Leader Development Conference) to reduce impact on leader calendars and TDY costs. (see Fig 14-2).

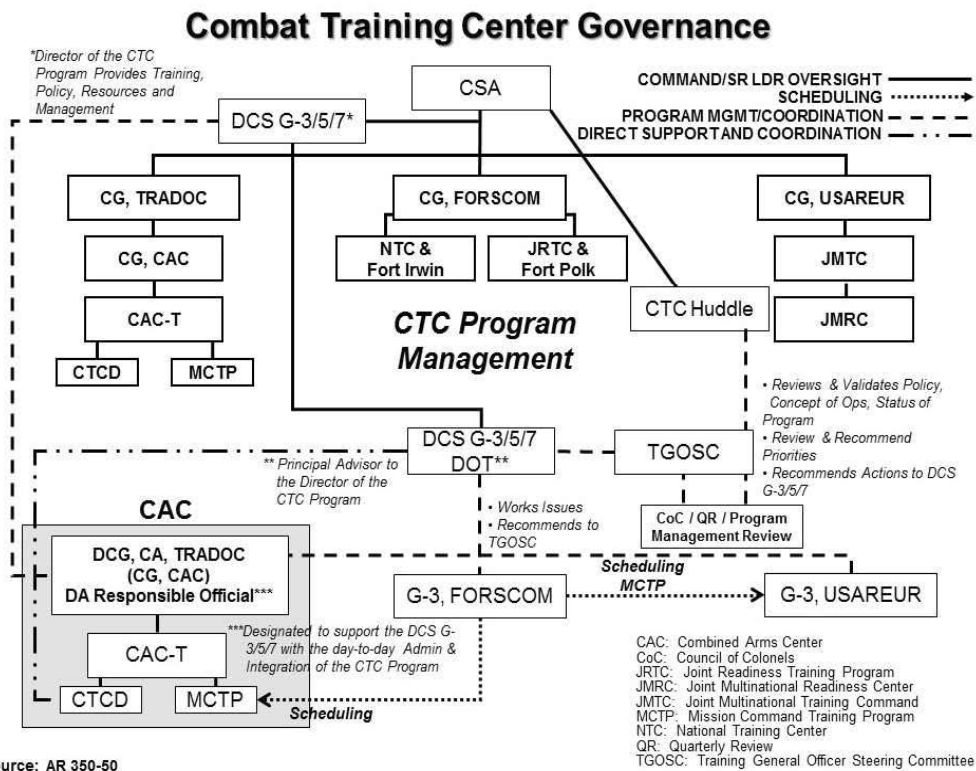

**Figure 14-2. Combat Training Center Governance**



**14-15. Army Total Force Policy (ATFP)**

The Army implements the ATFP to provide predictable, recurring, and sustainable capabilities to support the National Military Strategy (NMS) and Army commitments worldwide. The intent of the ATFP is to seamlessly blend active Army (AA), ARNG, and USAR units into a globally available, regionally-aligned, multi-component Army which synergistically supports the NMS.

**14-16. Unified Action (Joint, Interagency, Intergovernmental, and Multinational (JIIM))**

a. The Army builds forces capable of ULO, able to operate effectively with JIIM partners across the range of military operations, and provides those capable and ready forces to CCDRs in support of the National Security Strategy (NSS) and national defense strategy. JIIM partners provide access to capabilities and authorities not resident within the Army and serve as effective combat multipliers if properly included in the planning and conduct of operations.

b. Army formations must prepare to operate with JIIM partners. HQDA G-37 Training (TR) works with OSD-PR and Joint Staff (JS) J-7 to bring joint context to priority Army training venues, like CTC. Additionally, HQDA G-37 TR works with CCDRs and ASCCs to support Army participation in joint exercises. Incremental funds, costs over normal training funds, and transportation funds to move personnel and equipment to joint exercises are provided by OSD. (see AR 350-28).

**Section IV  
Institutional Training**

**14-17. Overview**

The Army institutional training and education system provides Soldiers, leaders, and Army Civilian Corps with attributes and competencies required to successfully operate in combat and at home station. Institutional training supports every Soldier and Army civilian in the force throughout his or her Army career.

**14-18. The Army School System (TASS)**

TASS is a composite school system made up of Active Component (AC), United States Army Reserve (USAR), Army National Guard (ARNG), and Army civilian institutional training systems. TASS conducts Initial Military Training (IMT) (e.g., Brigade Combat Team (BCT), One Station Unit Training (OSUT), Advanced Individual Training (AIT), and Basic Officer Leaders Course (BOLC B); reclassification training [e.g., Military Occupational Specialty (MOS) and officer branch qualification]; officer, warrant officer, Noncommissioned Officer (NCO) and Army civilian professional development training and education (e.g., Officer Education System (OES), Noncommissioned Officer Education System (NCOES), and Civilian Education System (CES); and functional training (e.g., Additional Skill Identifier (ASI), Skill Qualifications Identifier (SQI), Skill Identifier (SI), Language Identification Code (LIC). These training requirements are completed using standard resident and Distance Learning (dL) courses. The Reserve Component (RC) TASS units are functionally aligned and linked to appropriate training proponents.

a. Active Component (AC) Training Institutions. Serves as a link to the Reserve Component (RC) schools to ensure equivalency, quality assurance (QA), instructor certification, The Army Training System (TATS) courseware availability, use of the Analysis, Design, Development, Implementation, and Evaluation (ADDIE) curriculum design method, and a DL strategy. The TATS courseware ensures that all Army Soldiers, regardless of component, receive the same critical task instruction, regardless of which TASS institutions conduct the training or education.

(1) U.S. Army Training and Doctrine Command (TRADOC). Largest Active training institution in the United States Army. TRADOC oversees 34 Army schools (see list below) organized under eight Center of Excellence (Aviation, Cyber, Fires, Intelligence, Maneuver, Maneuver Support, Mission Command, and Sustainment (CASCOM). Each one focuses on a separate area of expertise within the Army (such as Maneuver and Signal). These Centers train over 500,000 Service members each year.

(2) TRADOC Centers of Excellence (CoE). The designated command or organization within an assigned area of expertise that:

- (a) Executes assigned responsibilities for one or more TRADOC core functions.

## HOW THE ARMY RUNS

(b) Provides TRADOC the ability to develop and integrate Doctrine, Organization, Training, Materiel, Leadership and Education Personnel, and Facilities (DOTMLPF-P) capabilities within and across the Army warfighting functions.

(c) Performs force modernization proponent responsibilities for the Army where assigned.

(3) TRADOC Centers and Schools. There are 34 TRADOC Centers and Schools:

(a) Adjutant General School, Fort Jackson, SC.

(b) Airborne School, Fort Benning, GA.

(c) Air Defense Artillery Center / School, Fort Sill, OK.

(d) Armor Center / School, Fort Benning, GA.

(e) Army Logistics University, Fort Lee, VA.

(f) Army Management Staff College, Fort Leavenworth, KS.

(g) Cyber Center / School, Fort Gordon, GA.

(h) Aviation Center / School, Fort Rucker, AL.

(i) Aviation Logistics School, Fort Eustis, VA.

(j) Chaplain School, Fort Jackson, SC.

(k) Chemical School, Fort Leonard Wood, MO.

(l) Command and General Staff College, Fort Leavenworth, KS.

(m) Drill Sergeant Schools, Fort Jackson, SC.

(n) Electronic Warfare School, Fort Huachuca, AZ

(o) Engineer School, Fort Leonard Wood, MO.

(p) Field Artillery Center / School, Fort Sill, OK.

(q) Finance School, Fort Jackson, SC.

(r) Infantry Center / School, Fort Benning, GA.

(s) Intelligence Center / School, Fort Huachuca, AZ.

(t) Irregular Warfare School, (location TBD)

(u) Military Police School, Fort Leonard Wood, MO.

(v) Officer Candidate School, Fort Benning, GA.

(w) Ordnance Mechanical Maintenance School, Fort Lee, VA.

(x) Ordnance Munitions and Electrics Maintenance School, Redstone Arsenal, AL.

(y) Physical Fitness School, Fort Benning, GA.

(z) Quartermaster Center / School, Fort Lee, VA.

(aa) Ranger School, Fort Benning, GA.

(bb) Recruiting and Retention School, Fort Jackson, SC.

(cc) School of Advanced Military Studies, Fort Leavenworth, KS.

(dd) School of Information Technology, Signal Center, Fort Gordon, GA.

(ee) School of Military Packaging Technology, McAlester, OK.

(ff) Sergeants Major Academy, Fort Bliss, TX.

(gg) Signal School, Fort Gordon, GA.

(hh) Transportation Center / School, Fort Eustis, VA.

(ii) Warrant Officer Career Center, Fort Rucker, AL.

(jj) Basic Leader Course, FORSCOM, USAREUR, EUSA, USASOC, and multiple locations within TRADOC, ARNG, and USAR.

(4) Non-TRADOC Schools include—

(a) Army Force Management School, Fort Belvoir, VA.

(b) Army Medical Department Center and School, Fort Sam Houston, TX.

(c) Army Inspector General School, Fort Belvoir, VA.

(d) John F. Kennedy Special Warfare Center and School, Fort Bragg, NC.

(e) United States Military Academy, West Point, NY.

(f) Criminal Investigation Laboratory, Fort Gillem, GA.

(g) Defense Ammunition Center and School, McAlester, OK.

(h) Army Management Engineering College, McAlester, OK.

(i) Corps of Engineers Professional Development Support Center, Huntsville, AL.

(j) Prime Power School (under Engineer School effective FY09-10), Fort Leonard Wood, MO.

(k) Army Safety Center, Fort Rucker, AL.

(l) University of Foreign Military and Cultural Studies (Red Team), Fort Leavenworth, KS.

(m) Army War College, Carlisle Barracks, PA.

- (n) Reserve TASS (Army School System), various CONUS and OCONUS locations.
- (o) ARNG TASS (81 schools, including 54 Regional Training Institutions), various CONUS and OCONUS locations.
- (p) Cadet Command controls hundreds of University and College ROTC sites (Basic Officer Leader Course (BOLC) A).

b. Reserve Component (RC) Training Institutions (see Fig 14-3).

(1) United States Army Reserve (USAR). Provide component infrastructure organized into training commands with brigades and battalions. These elements deliver institutional training at multiple geographic resident and DL locations using courseware approved and distributed by the Army training proponents through the USARC. The USAR TASS unit, the 80th Training Command (TC) conducts MOS reclassification, NCOES, OES, ASI/SQI, and functional courses. With an MOA between their parent headquarters, the USARC, and with TRADOC, the 80th TC is tasked to manage planning and execute the assigned Army Program for Individual Training (ARPRINT) as directed by HQDA G-1/G-3/5/7 from the SMDR and as coordinated by TRADOC; report school execution trends, report forecast mission conflicts, and identify forecasted constraints; update TRADOC TASS Readiness Reporting System (TTRRS) monthly as required; participate in the TACITS process in support of the One Army School System; participate in the POI development process at the proponent level; and, augment TRADOC proponent schools with Quality Assurance Officers, instructors, and support personnel (note: through the approval of Army Campaign Plan Decision Point 74, the Chief of Staff, Army directed TRADOC to take OPCON of the 80th TC (TASS) on 1 October 2009).

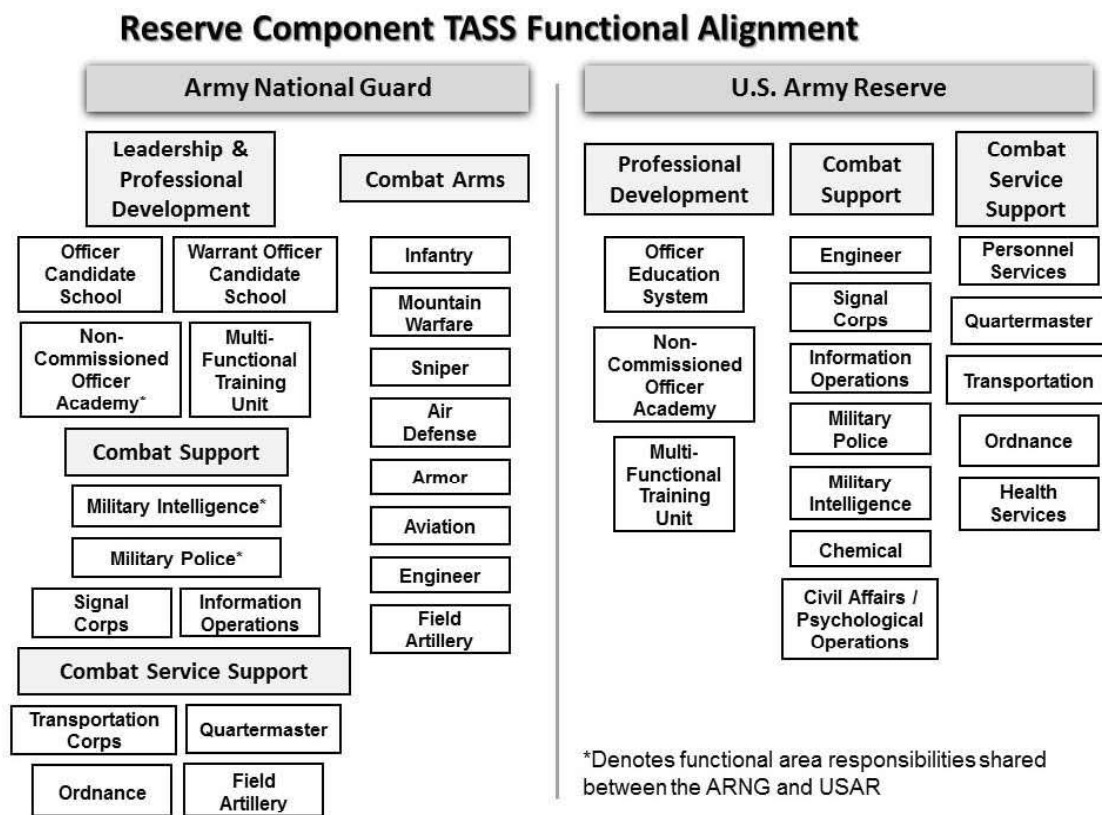

**Figure 14-3. Reserve Component The Army School System Functional Alignment**

(2) The Army National Guard (ARNG). TASS is missioned to train OCS, WOCS, MOS reclassification, NCOES, ASI and functional courses in leadership, maneuver, fires and effects (MFE); operations support; and force sustainment training lanes. ARNG shares leadership, operations support and force sustainment lanes with USAR TASS schools. TASS divides the CONUS and territories into six regions based on geographic and demographic data (active and reserve force structure). Based on mission

training requirements, each region includes officer education (OCS, WOCS, officer professional development), enlisted education (MOS reclassification training, NCOES), functional, ASI and SQI courses. TASS training battalions, subordinate to the brigades/regiments, align with the proponents for each career management field. Battalions manage instructor groups. Each instructor group has multiple teaching sites that ensure the availability of decentralized instruction for all Soldiers. Respective states have ARNG TASS training regiments aligned within the state, but provide similar regional coverage for training of Soldiers of all components.

### **14-19. Joint Professional Military Education and Training Institutions**

a. Joint education institutions prepare officers and DOD civilians for assignments at Joint or combined headquarters/commands. Joint Professional Military Education (JPME) is governed by the Chairman Joint Chiefs of Staff Instruction (CJCSI 1800.01E) Officer Professional Military Education Policy (OPMEP). JPME is a subset of PME; it begins at pre-commissioning institutions and weaves through General Officer education. JPME provides the body of knowledge to enhance performance of duties consistent with Joint Matters and in the context of joint functions – command and control, intelligence, fires, movement and maneuver, protection and sustainment. JPME is that portion of PME that supports fulfillment of the educational requirements for joint officer qualification (see Title 10, Chapter 38, Section 661(c) and DODI 1300.19 DOD Joint Officer Program, dtd 4 Mar 2014 for joint officer qualifications). The education generally prepares students to accomplish Joint command and staff functions and to perform strategic and operational planning.

b. The Army's accredited JPME institutions are the Command and General Staff School (JPME I), the Advanced Strategic Leadership Studies Program (JPME II) and the U.S. Army War College Resident Program (JPME II), Distant Education Program (JPME I and working on JPME II). Other JPME institutions include: Sister Service Command and Staff level institutions (JPME I), National Intelligence University (JPME I), Sister Service War Colleges (JPME II), National Defense University, at Ft McNair, Washington, DC, programs include the National War College (JPME II), The Eisenhower School (JPME II), the College of International Security Affairs (JPME II senior program only), and the College of Information and Cyberspace (JPME II senior program only) as well as the Joint Forces Staff College, Norfolk, VA, that include the Joint Advanced Warfighting School (JPME II), Joint and Combined Warfighting School (JPME II) and Advanced Joint Professional Military Education (AJPME) course (Currently for RC Only, JPME II equivalent, supports Joint Qualification Level III, working to open to all components and full JPME II accreditation).

c. Specialized courses focused on a particular command or multi-national audiences such as the North American Treaty Organization (NATO) are also available. The NATO School Oberammergau, Germany (<https://www.natoschool.nato.int/>) offers the NATO Staff Officer's Orientation Course; this course is mandatory for all AA and AGR officers in the grade of O-4 through O-6 selected for an initial assignment to a NATO staff position. The course acquaints students with NATO missions, organizations, and procedures, preparing graduates for their NATO Assignments and ensuring effective interaction with their allied colleagues.

### **14-20. Institutional Leader Training and Education Categories**

Much of the OES, WOES, NCOES, and civilian curriculums are complementary in that they support the development of leaders for utilization at specific organizational levels. It is the foundation upon which leaders realize their maximum potential. Training and education usually precede significant new and higher levels of operational assignments. It consists of branch-specific courses and functional training. The courses identified below correspond to the organizational levels listed.

a. Officer Pre-Commissioning Programs educate and train cadets, officer candidates, warrant officer candidates and assess their readiness and potential for commissioning as second Lieutenants or as WO1s. Pre-commissioning programs prepare the individuals for progressive and continuing development. Chapter 2 of AR 350-1 covers the U.S. Army and ARNG. Pre-Commissioning programs are as follows: BOLC Phase A, WOCS, ROTC, USMA, OCS, Direct Commissioning (detailed information reference Pre-commission Training is in AR 350-1, pg 68, paragraph 3-32). Warrant Officer Candidate School (WOCS) is a branch-immaterial course that prepares enlisted Soldiers to serve as a WO1 in the AA, ARNG, and USAR. WOCS incorporates a high stress environment designed to challenge the warrant officer candidate from day one. Candidates attend training at the WOCC, Fort Rucker, AL.

ARNG and USAR candidates who are eligible may alternatively attend WOCS at a State Regional Training Institute.

b. Initial Military Training (IMT) provides an orderly transition from civilian to military life. It is the first step to transforming civilians into Soldiers. It teaches Soldier the tasks and supporting skills and knowledge needed to be proficient in required skills at the first unit of assignment. IMT consists of Basic Combat Training (BCT), Advanced Individual MOS Training (AIT) / One Station Unit Training (OSUT) and BOLC-B.

c. Initial Entry Training (IET) produces technically and tactically competent Soldiers who exemplify Army values, live Warrior Ethos, and are prepared to take their place in the ranks of the Army. For enlisted Soldiers, it includes traditional basic combat training, AIT, one station unit training, or other formal Army individual training received prior to entry.

d. Professional Military Education (PME). Refer to Section IX, Leader Development, for detailed information pertaining to PME.

e. MOS-T Reclassification Training is intended to qualify an individual in a new MOS. Upon satisfactory completion of the training the new MOS will be awarded to the Soldier and designated as the Primary MOS. Soldiers attending MOS-T training for reclassification are afforded the same privileges as permanent party members of equal grade. MOS-T (reclassification) courses have non-MOS-specific (e.g., common core) tasks removed by the proponent, as Soldiers attending these courses have already completed IMT and do not need to repeat basic Soldiering training. AA Soldiers may attend training at TASS BNs if the BN is accredited and teaching TATS-C delivered in ADT mode (see detailed information on MOS-T in AR 350-18, pg 24, paragraph 3-6).

f. Functional Training provides qualified Soldiers and Army Civilians for skill specific training to duty positions that require specific functional skills (e.g., additional skill identifier (ASI), special qualification identifier (SQI), or skill identifier (SI)) and knowledge, such as Airborne and Ranger training. It may provide training that qualifies Soldiers for award of an ASI, SQI, or SI, produce ASI / SQI-trained and qualified Soldiers, and provide other functional training required for a specific deployment (Mission Readiness) and follow-on assignments.

g. Civilian Education System (CES). See Section IX, Civilian Training and Leader Development.

## 14-21. Conduct / Method of Instruction

Some TASS institutions and units focus on education as the primary method of instructions while others may focus on training. Many TASS units use a combination of both methods of instructions through a variety of courses.

a. Resident training is conducted at centralized training sites with required ranges, facilities (classrooms, housing, subsistence, and so forth) and equipment to support all training requirements (for example, Army schools and training centers). Priority for conducting resident training will be determined by the training Army Command (ACOM).

b. Nonresident training is individual training distributed to students for completion without the presence of an on-site instructor / facilitator, small group leader or otherwise designated trainer.

(1) Distributed Learning (DL) is the delivery of standardized individual, collective and self-development training to Soldiers, Army Civilians, units, and organizations at the right place and right time through the use of computer based technologies. DL may involve both synchronous (in real time—for example, via two-way audio/video television) and asynchronous (non-real time—for example, via CBT) student-instructor interaction. It may also involve self-paced student instruction without benefit of access to an instructor (for example, correspondence programs). For additional information on distributed learning (DL) development requirements Reference the Web site for TRADOC administrative publications: <http://www.tradoc.army.mil/tpubs/> and/or the CAC Web site for current guidelines for DL requirements.

(2) Mobile Training Teams (MTT) consist of one or more U.S. military or civilian personnel sent on temporary duty, often to a foreign nation, to give instruction. The mission of the team is to train indigenous personnel to operate, maintain, and employ weapons and support systems, or to develop a self-training capability in a particular skill. The Secretary of Defense may direct a team to train either military or civilian indigenous personnel, depending upon host-nation requests.

(3) Video Tele-Training (VTT). Fiscal constraints and lower TDY budgets pose challenges for training Soldiers for combat and other missions. The Army has established a program that reduces the need for TDY and allows one instructor to teach many Soldiers at different locations by using the Video Tele-training (VTT) program. The U.S. Army VTT program broadcasts training courses to Soldiers whether

they are in a classroom at Fort Benning, GA, or at a point of delivery site such as a digital training facility in Wiesbaden, Germany. The Army Training Support Center at Fort Eustis, VA administers the VTT program and is part of a wider initiative to take training and education outside classroom walls which fits well with the Army Learning Model (ALM) 2015, which is changing the Army's individual learning methods and processes.

(4) Train the Trainer courses are created to deliver specific learning objectives and how they should be taught to selected individuals who will return to their units and pass the information along. These new trainers typically do not have any additional duties beyond conducting and recording the training. This is not the same as creating unit Subject Matter Experts or Additional Duty personnel who, along with conducting the training, have additional administrative and advisory duties to conduct for the commander. As an example, the recent training for the new Noncommissioned Officer Evaluation Report (NCOER) document was conducted via Train the Trainer to deliver the information to the units. Whereas the Sexual Harassment /Assault Response & Prevention (SHARP) training or Master Gunner training produces personnel who conduct additional duties and responsibilities in addition to providing training to the unit.

(5) On the Job Training (OJT) is a formal training program with specific learning objectives conducted by a trainer when the learner is performing the duties being trained. OJT is limited to the immediate performance of short term duties.

d. ATRRS. ATRRS is the Army's Management Information System of record for student input to training. The on-line system integrates manpower requirements for individual training with the process by which the training base is resourced and training programs execution is recorded. This automation support tool contains: training requirements; training programs; class schedules; class quotas; student reservations; and student input and graduation data. It supports numerous Army processes to include SMDR. The product of the SMDR is the ARPRINT, the mission document and input factor for resourcing the institutional training base during peacetime and mobilization. ATRRS supports the Training Requirements Division of the Office of the DCS G-1 in its Army-wide mission of integrating all phases of input to training management, during peacetime and mobilization. The system supports the planning, programming, and budgeting processes.

### **14-22. Development of the Army Individual Training Requirements**

a. General. The development of individual training for the AC begins with the identification of force structure authorizations from the Personnel Management Authorizations Document (PMAD) and AA Military Manpower Program (AAMMP). The Army G-1 produces the PMAD semiannually, usually in August and January. PMAD displays authorizations at the MOS and grade level. The Army G-1 also produces the AAMMP on a monthly basis. It contains manning data such as AC end strength, monthly recruiting requirements, and inputs to training for seven FYs.

b. MOS Level System (MOSLS). Using the PMAD, the MOSLS process predicts AC (enlisted) skill requirements. MOSLS compares MOS and grade inventory, aged to the FY under consideration by applying gain, loss, and promotion factors. The difference between the authorizations and the aged (to the FY) inventory constitutes the number of trained Soldiers, by skill that the training base must produce (output). Applying training attrition rates at the skill level provides the number of Soldiers required to begin training (input).

c. Other training requirements. HRC identifies other training requirements for officer and enlisted in-service personnel who require training and education to support professional development, reenlistment or reclassification programs, and mission requirements. The Army G-1 identifies training requirements for Army civilians. Additionally, HRC solicits in-service training requirements from other ACOMs, ASCCs, DRUs, States' Adjutant Generals, and other services and agencies via the TACITS. HRC conducts the TACITS survey annually. The accession-driven, in-service, and other task based training requirements are combined as total raw training requirements within the ATRRS. The ATRRS' automated databases include a list of Army task-based training courses that includes length, capacity, frequency, and location. It also includes other services' courses attended by Army personnel. The task-based requirements are translated into course requirements and become the Army's training requirements at the course level of detail by component and FY.

d. Training program development for each MOS / AOC. After the training requirements for courses are developed, the next major task in the process is the development of the training program for each MOS / AOC. The first step in establishing a training program is the SMDR, co-chaired by ODCS, G-1 and

ODCS, G-3. It includes representatives from: ODCS (G-1, G-3/5/7, and G4); OTSG; TRADOC; AMC; AMEDDCS; HRC; FORSCOM; NGB; OCAR; USAREC; Office of the Chief of Engineers (OCE); other services; FMS; International Military Education and Training (IMET); and the individual proponent schools. The purpose of the SMDR is to reach a consensus within the Army for the ITP for the first and second POM years and any major changes for the upcoming budget year. Additionally, the SMDR validates training requirements (Soldiers and civilians to be trained in formal education / training courses), compares training requirements with schoolhouse current resource capabilities (facilities, billeting, manpower), and adjusts training requirements or training resources to form recommended training programs. The SMDR is conducted annually in October. Individual training requirements are initially established for the third POM year, validated for the second POM year (the primary focus of the SMDR), and fine-tuned for the first POM year.

e. SMDR categorization by course. The SMDR categorizes each course. The first category is composed of those courses where the total training requirement can be trained with available resources. The second category consists of courses where the requirements exceed the resourced capability of the training base. In the second category, resources can be provided or requirements reduced to the resourced level without significant impact on the manning program. The third category represents those courses where the requirement exceeds the capacity, requires significant resources, and cannot be reduced without significant impact on the manning program. These courses are termed constrained. The results of the SMDR are briefed to a CoC which attempts to confirm category two adjustments / resources and move as many courses as possible from category three to category two.

f. GOSC. The courses in categories two and three are then referred to a GOSC co-chaired by the Director of Training (DOT) and the Director of Manpower and Personnel (DMP). At this meeting, GOs take action on the recommendations of the CoC. Each course remaining constrained is reviewed as to current authorizations, projected operating strength, training requirements, training capability, source of constraint, resources required to eliminate the constraint, availability of required resources, and a recommended course of action. That review results in a resourced training requirement that is called an approved training program for each course for that FY.

g. ARPRINT. After the GOSC is completed, the ODCS, G-1, Training Requirements Division publishes both the training requirement and the training program in the ARPRINT. The ARPRINT is a mission document for the training base as well as the Army in terms of recruitment and professional development education. The ARPRINT identifies, by FY, projected individual training requirements for established courses and for task-based courses for new course requirements. Based on identified training requirements, subsequent actions are taken to provide resources (manpower, money, facilities, ammunition, and equipment) to train the required number of Soldiers and Army civilians. The desired flow of Soldiers into the schools and training centers aids in development of class schedules to support the ARPRINT-approved training requirements for each course. The class schedules are entered into ATRRS. TRADOC reviews the class schedules to ensure they support the ARPRINT requirement and TRADOC scheduling policy.

h. Mobilization Planning System (MPS). The MPS is a subsystem of ATRRS. It provides training managers, at or above installation level, prompt access to information necessary to plan for implementation of the mobilization of the Army training base. The MPS helps produce the Mobilization (MOB) ARPRINT which provides a projection of trainee and student inputs, by task-based course, to satisfy post mobilization requirements for trained manpower as determined by Mobilization Manpower Planning System (MOBMAN).

## **14-23. Management of the Army Individual Training Requirements and Resources**

a. The Structure and Manning Decision Review (SMDR) is the forum that validates Army training seat requirements and subsequently reconcile those requirements to an affordable, acceptable, and executable training program (see Fig 14-4). Training requirements are initially established for the third program objective memorandum (POM) year, validated for the second POM year (the primary focus of the SMDR), and fine-tuned for the first POM year. Where possible, achievement of the fine-tuning goal is based on the funded capabilities of the training activities (see AR 350-10).

## Structure and Manning Decision Review Overview

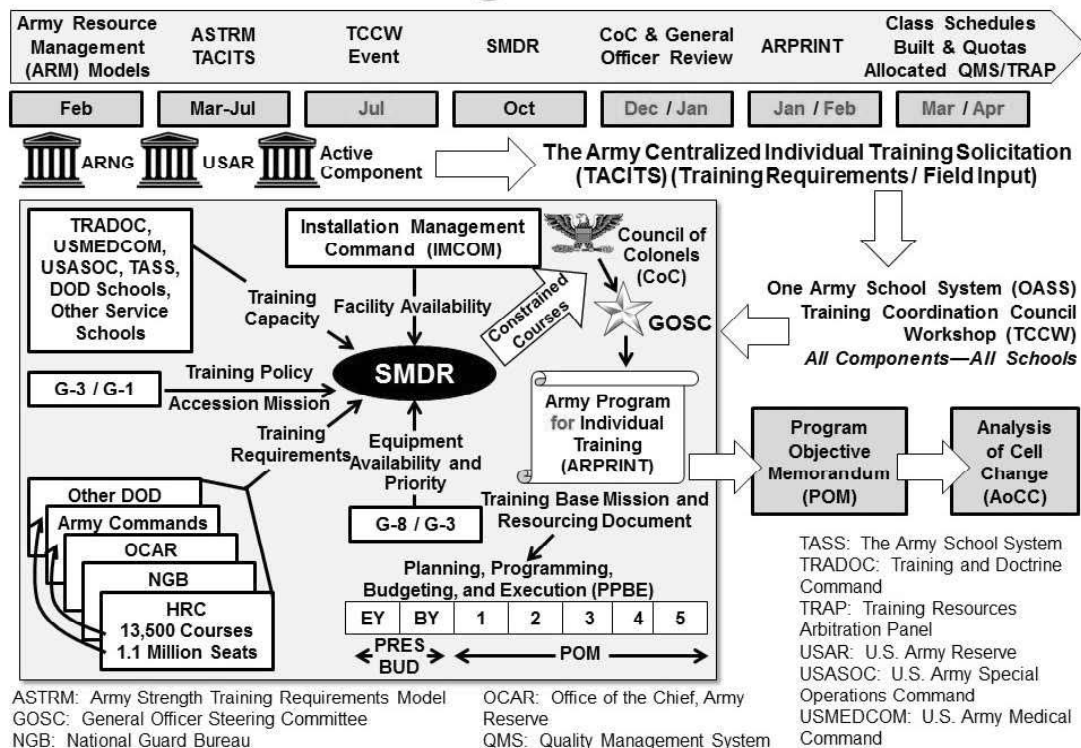

Figure 14-4. Structure and Manning Decision Review Overview

b. The Training Resources Arbitration Panel (TRAP) addresses unprogrammed training-seat changes to the ARPRINT during the execution and budget years. These changes can generate unprogrammed resource requirements such as additional manpower, base operations (facilities, meals, lodging), equipment, ammunition, and funding, for which commands may require resourcing through HQDA. If unprogrammed resourcing through HQDA is required, the TRAP helps HQDA determine whether to approve the unprogrammed training-seat changes or disapprove and accept risk. HQDA, DCS, G-3/5/7 and HQDA, DCS, G-1 co-chair the TRAP. Detailed guidance on the TRAP process is included in AR 350-10.

c. The Analysis of Change Cell (AoCC) is a forum that addresses issues impacting training in the budget and execution years too complex to address in the TRAP or SMDR. Its role is to develop recommendations to resolve critical issues impacting inputs to programmed training. Issues include, changes in training loads generated by changes in current authorization documents, Army policies, current manpower inventory, projected gains and losses, training attrition rates, training strategies and availability of resources. Policy guidance on the analysis and change cell is included in AR 350-10.

d. The Total Army Centralized Individual training Solicitation (TACITTS) is a module in the Army Training Requirements and resources System (ATRRS) database, which federal and DoD agencies, the total Army, other services, Security Assistance Training Field Activity (foreign military training requirements), and civilian agencies use to submit their individual training seat requirements to compete for validation during the SMDR.

e. Training Requirements and Resources Governance. The Input to Training Management General Officer Steering Committee (ITM GOSC) role is to approve the ARPRINT and to resolve critical issues that impact the Army's individual, institutional training missions (ARPRINT). The offices of the DCS G-1 and the G-3/5/7 co-chair the ITM GOSC.



**14-24. The Army University**

a. The Army reorganized its educational enterprise into a university structure in order to maximize educational opportunities for Soldiers by providing valid academic credit for the education and experience they receive while on active duty. This effort was intended to provide a cost savings to the Army in tuition assistance and unemployment expenses, and improve a Soldier’s ability to transition into quality employment opportunities after their service. The Army University encompasses all TRADOC schools, provides the force with a single point of contact for all Army education matters, and addresses the educational needs of the Army while providing individual Soldiers and civilians the opportunity to accomplish their own respective academic goals. In addition, Army University will work closely with the U.S. Army War College at Carlisle, PA; the Warrant Officer Candidate School at Fort Rucker, AL; the Command and General Staff College at Fort Leavenworth, KS; and the U.S. Army Centers of Excellence (CoE) to leverage capabilities for training and research. The purpose of Army University is to: provide professional degree and credentialing opportunities; communicate the value the Army places on education; gain national recognition as an accredited educational institution; increase partnering with public and private universities; and identify talent and integrate best practices across the education system. As shown (in figure 14-4), the Army University integrates all of the schools across TRADOC into a single educational structure modeled after many of the state university systems seen across our country. This includes all elements of officer, warrant officer, non-commissioned officer and civilian education systems. It includes educational programs in the active and reserve components and the ROTC pre-commissioning program.

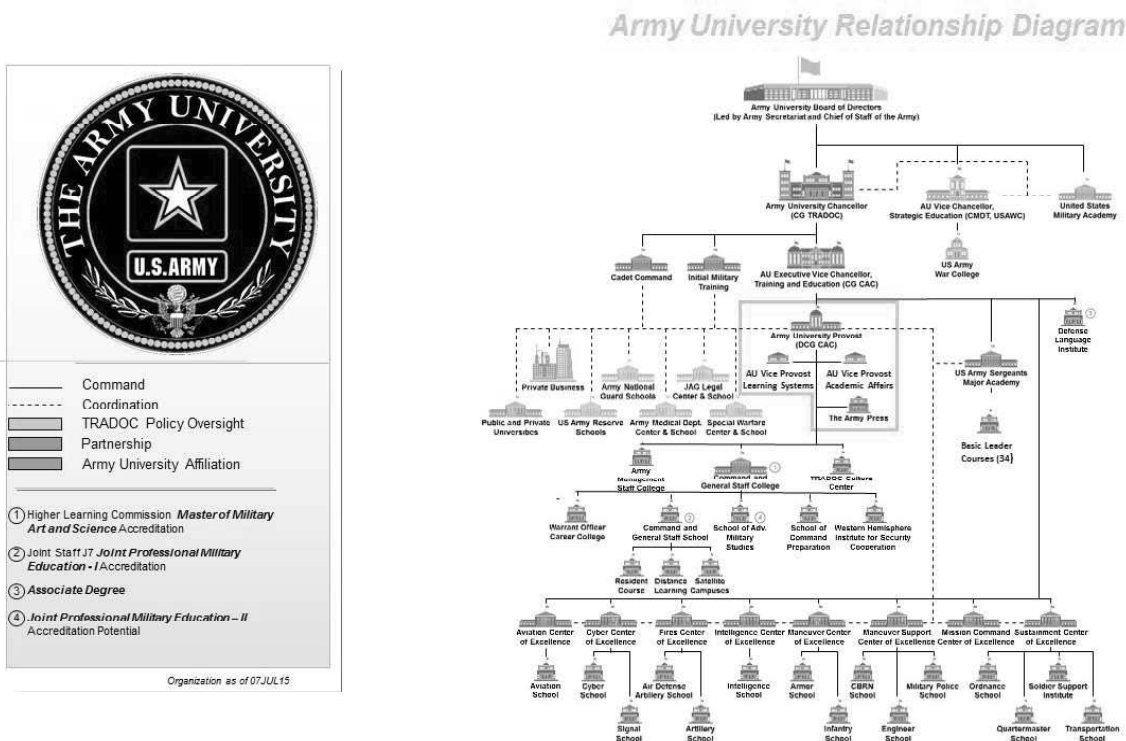

**Figure 14-5. The Army University**

b. U.S. Army War College (USAWC). The USAWC will serve as the focal point and enterprise coordinator for strategic education and research in the Army University construct while remaining a separately accredited and governed graduate college. As such, it retains a unique status as a direct reporting unit to the Chief of Staff of the Army. The USAWC Commandant will be dual-hatted as the Army University’s Vice Chancellor for Strategic Education, responsible to educate strategic leaders, provide enterprise level guidance on strategic education across the Army, and conduct research for the Army senior leadership. The USAWC will receive direct guidance on its missions and strategic educational requirements from the Chief of Staff of the Army, maintain independent budget authority

## HOW THE ARMY RUNS

(including over any gifts received from its 501(c)(3) foundation), and operate under the oversight of a separate Board of Visitors. The USAWC will also continue to participate in all working groups and boards associated with the Army and Joint educational requirements. The second driver for this unique status within the Army University is the statutory requirement for the USAWC to grant a master's degree. In order to award the master's degree required by United States Code, the USAWC must meet the standards of their regional accrediting body, the Middle States Commission on Higher Education, which is a different regional accrediting body than that of the Army University. The Middle States Commission requires the USAWC to control the academic governance of their institution through their Commandant and Provost in order to retain their regional accreditation. Likewise, the USAWC is accredited by the Joint Staff for its award of JPME II and thereby responds to the Military Education Coordination Council and J-7. Finally, the USAWC Commandant has recently been tasked to execute and coordinate all Army General Officer education from Brigadier through Lieutenant General. Therefore, the USAWC must retain its unique status within the Army University and its direct report status with the Office of the Chief of Staff of the Army.

### **Section V** **Military Functional Area and Skill Training**

#### **14-25. Overview**

Functional courses prepare Army personnel for assignment to special units or specific duty positions and increase their value to the Army. These courses provide Soldiers an opportunity to acquire duty position-required skills and knowledge that cannot be obtained by attending other institutional courses. The courses may provide training which qualifies Soldiers for award of an ASI, SQI, or skill identifier (SI). The ATRRS course catalog has a complete listing of functional and skill-qualification courses.

a. The CG, Human Resources Command (HRC), will assign AA personnel other than chaplains, AMEDD, and Judge Advocate Generals Corps (JAGC) personnel to attend specialty courses in a temporary duty (TDY) en route in conjunction with a permanent change of station (PCS) or officer accessions. Soldiers on a PCS status attend courses or a combination of courses totaling 20 weeks at one location. Each proponent with training responsibilities develops course prerequisite qualifications specified in the ATRRS course catalog ([www.atrrs.army.mil](http://www.atrrs.army.mil)).

b. ACOMS, ASCCs, and DRUs will assign AA personnel to attend specialty courses in a TDY and return status.

c. The Defense Acquisition University (DAU) is a corporate university that provides mandatory training for all acquisition, technology and logistics workforce members. DAU also provides a full range of basic, intermediate, and advanced curriculum training, as well as assignment-specific and continuous learning opportunities to support the goals and professional development of the Department of Defense (DOD) Acquisition, Technology, and Logistics (AT&L) workforce.

#### **14-26. Joint Education and Training Institutions**

Joint education institutions prepare officers and civilians of all services for assignments at joint or combined headquarters or commands. The education generally prepares students to accomplish joint command and staff functions and to perform strategic and operational planning. Joint education institutions may offer specialized courses focused on particular joint or combined assignments. The North Atlantic Treaty Organization (NATO) Staff Officers Orientation Course is an example of this type of course. The NDU at Fort McNair, Washington, DC, presents the course various times throughout the year. Attendance at the NATO Staff Officers Orientation Course is mandatory for all AA and active guard reserve (AGR) officers in the grade of O-4 through O-6 selected for an initial assignment to a NATO staff position. The course acquaints students with NATO missions, organizations, and procedures, preparing graduates prepared for their NATO assignments and ensuring effective interaction with their allied colleagues.

## Section VI Future of Army Training

### 14-27. Overview

Army education and training is changing from the traditional classroom, instructor presented lessons to a combination of resident, distributive learning (dL), and unit training. This approach leverages automation technologies to improve the efficiency of producing, distributing, and implementing instruction. This change affects individual and collective training. The automation network serves as the conduit for producing and distributing learning material to Soldiers, leaders, and units to meet their specific needs to train and prepare for a broad spectrum of global contingencies. The use of automation technologies does not change performance standards expected of Soldiers, civilians, and units. Reliance on traditional training methods will continue; however, the availability and communications power of the commercial world-wide web, internet, and other information transfer systems will enhance training. To attain this vision, the Army launched a number of projects to provide a solid education and training information foundation. ATRRS is the means to register for Army education and training to include dL courses. Beginning in FY14, registration for training and education for Army civilians was accomplished through the use of GoArmyEd, a system currently in use by the Army Continuing Education System (ACES) for Soldier tuition assistance. ATRRS facilitates student enrollment, class scheduling, registration, tracking of training records, and financial tracking for most training and education courses used by Army civilians.

a. Learning Environment. Classroom learning is shifting from instructor-centered, lecture-based methods, to a learner-centered, experiential methodology. Knowledge and comprehensive learning objectives and individual learning activities occur outside the classroom. This includes self-paced technology-delivered instruction and research. Students and trainees will participate in discussion, collaborative learning activities, problem identification, and small-group problem solving. Engaging the learner in collaborative practical and problem-solving exercises relevant to their work environment provides an opportunity to develop critical competencies—initiative, critical thinking, teamwork, and accountability, in addition to specific knowledge content.

b. dL. To meet the challenge of the future, the Army is implementing dL to deliver education and training to the Soldier whenever and wherever needed. Types of dL include interactive multimedia instruction (individualized self-paced instruction), video teleconferencing, web-managed instruction, and simulations. Army dL does not fundamentally change the way the Army trains, it enhances training by using current and emerging technologies for management and delivery of training to the Soldier at the point of need. Exploiting these technologies takes the classroom to the unit, and the unit to the classroom, providing training in a worldwide virtual training environment (TE). Soldiers in the field, in units, at institutions, and at home can train by accessing the informational databases through the Army Knowledge Online (AKO) website. Units can select training options (resident and non-resident) based upon their need, time available to train, distance from the “on-site” training site, and other resource constraints. The dL System (DLS) uses an integrated learning management support system, which automates student enrollment, scheduling, and training records. DLS delivers digital courseware to include real-time video tele-training (VTT), video and audio recordings, web- and computer-based training materials, and simulations. Army dL documents and related materials are available on the internet at

<http://www.atssc.army.mil/tadlp/index.asp>. Types of dL include:

(1) Army Learning Management System (ALMS). ALMS is the heart of the Army's DLS. ALMS streamlines, consolidates, and provides overall direction to the Army's training processes. ALMS is a web-based information system that: delivers training to Soldiers; manages training information; and provides training collaboration, scheduling, and career planning capabilities in both resident and non-resident training environments. The ALMS also assists Army trainers and training managers in conducting and managing the training of Soldiers and Army civilians throughout their careers.

(2) Digital Training Facilities (DTF). DTFs provide training access for the Army's Soldiers and civilians at AA installations and USAR training sites.

(3) Deployed Digital Training Campus (DDTC). The DDTC is a deployable networked classroom that delivers proponent approved dL training using satellite communications (SATCOM), wireless connectivity, and VTT equipment. SATCOM provides linkage to deployed forces worldwide through the following: VTT; video teleconference (VTC); world-wide web (WWW); non-classified internet protocol router network (NIPRNET); and schoolhouse resources not reachable through other means.

## HOW THE ARMY RUNS

(4) ARNG dL Classrooms (DLC) and Mobile DLC (MDLC). The ARNG dL program is a component of the Army dL program. It provides multiple dL methods and technology-enabled standardized individual and collective training relevant to the readiness requirements of Soldiers and units throughout the ARNG.

(5) TRADOC Enterprise Classroom Program. The program includes Classroom XXI (CRXXI), MC Art and Sciences Program (MCASP), Basic Combat Training (BCT) / One Station Unit Training (OSUT), and the Institutional Training Technology Program (ITTP). Enterprise classroom programs sustain instructional capabilities that support approved training requirements and priorities that enable Army Learning Model 2015.

### Section VII Training Governance

#### 14-28. Training General Officer Steering Committee

a. Structure. The Training General Officer Steering Committee (TGOSC) governs the Training Enterprise. It provides vision, goals, objectives, and direction to the Training Enterprise, as well as critical input to the Army Planning, Programming, Budgeting, and Execution (PPBE) process. The TGOSC leads a quarterly management process that recommends improvements in training policy and strategy, and capabilities needed to provide trained and ready Soldiers, leaders, civilians, and units to the combined, joint, interagency, and multinational forces of CCDRs. In addition, the TGOSC ensures Army training domains (operational, mission, institutional and training support systems) can sustain requisite Soldier, leader, civilian, and unit readiness, and can support Army and DOD transformation requirements.

(1) The HQDA DCS G-3/5/7 chairs the TGOSC, with the Director of Training (DOT) or Deputy Director of Training (DDOT) serving as chair in his absence. The DCS G-3/5/7 DOT and the DCS G-1, Director of Military Personnel Management, represent the Army Staff (ARSTAF) as voting members. Other ARSTAF may be invited.

(2) Primary TGOSC members are also voting members and include general officers (GO) or Senior Executive Service (SES) members from each ACOM, ASCC, and DRU, ARNG, and USAR who are responsible for training and leader development. The TGOSC chair may invite other HQDA and Joint Staff GOs or SES to attend based on the issues being presented.

(3) Generally, each 1-2-star TGOSC is followed by a 3-star TGOSC video teleconference (VTC) to address key emerging or contentious topics that cannot be resolved at the 1-2-star TGOSC. The 3-star TGOSC provides a back brief to the Army senior leaders concerning the outcome from the TGOSC cycle.

(4) Meeting Frequency. The TGOSC meets quarterly (or as required) to identify and resolve issues, determine priorities, and make decisions in support of Army training and leader development to provide synchronized and integrated strategic recommendations to Army senior leaders. A number of councils of colonels support the TGOSC to develop and frame training-related issues for Army leaders' decision.

(5) Purpose. The TGOSC provides a management process to identify and resolve issues, determine priorities, and make decisions in support of Army training and leader development in order to develop synchronized and integrated strategic recommendations for the Chief of Staff of the Army (CSA) in support of Army Transformation and Force Readiness. All TGOSC recommendations will consider policy implications, impact if not adopted, general resource requirements, and general priority in relationship to other Army training and leader development initiatives.

(a) Fall TGOSC. The Fall TGOSC has a two-fold purpose: First, to provide comprehensive guidance to the Training Program Evaluation Group (TT PEG) in order to shape the program objective memorandum (POM) plan to maximize training balance and readiness. Second, to incorporate key stakeholder input to provide the opportunity to prioritize their requirements. Key inputs include: Short Range Training Requirements Analysis (SRTRA); Non-System Training Devices (NSTD); Strategic Portfolio Analysis Review (SPAR); Structure Manning Decision Review (SMDR); Execution Assessment; Senior Leader Readiness Forum (SLRF) Task status; the Army Profession and Leader Development Forum (APLDF) initiatives; and the Army Leader Development Program Priority List (APL); and by exception, directed requirements. A combined Council of Colonels (CoC) and associated Integration Forum precedes the Fall TGOSC. Key outputs include a balanced TT PEG assessment and prioritization and an updated CTC Huddle Agenda. The Fall TGOSC is targeted to occur annually NLT 15 November.

(b) Winter TGOSC. The Winter TGOSC has a two-fold purpose: First, to provide the adjusted POM Plan in order to review and approve PEG balance and risk; Second, to build and influence mid-year

review (MYR) for the current fiscal year (FY). Key inputs include: the PEG Guidance Adjustment, Commander’s Narrative Assessment Concerns. The Combined Council of Colonels (CoC) and Integration Forum will precede the Winter TGOSC. Key outputs include the Adjusted POM Plan and Technical Guidance Memorandum (TGM) shaping guidance. The Winter TGOSC is targeted to occur annually NLT 28 February.

(c) Spring TGOSC. The Spring TGOSC has a two-fold purpose: Review the MYR for the current fiscal year in order to identify and attempt to mitigate risk; and shape new initiatives for future decision in order to examine and assess initiatives. The Combined CoC and associated Integration Forum will precede the Spring TGOSC. Key outputs include the MYR, Way Ahead and Prioritization; SLRF Agenda; and Decision Point for Summer TGOSC. The Spring TGOSC is targeted to occur annually NLT 30 May.

(d) Summer TGOSC. The Summer TGOSC has a three-fold purpose: Assess the next FY budget for balance and risk and to gain understanding of immediate risk and resource challenges; assess the upcoming Budget Estimation Submission (BES) (first year of preceding POM) in order to gain understanding of upcoming risk and resource challenges; confirm new initiatives for inclusion in the TT PEG guidance; validate and prioritize emerging requirements for the TT PEG. The CoC and associated Integration Forum precedes the Summer TGOSC. The key output is the decision on new initiatives and/or policy changes. The Summer TGOSC is targeted to occur annually NLT 30 September.

TGOSC Governance				
	4 <sup>th</sup> Quarter / Summer (VTC)	1 <sup>st</sup> Quarter / Fall (Live)	2 <sup>nd</sup> Quarter / Winter (VTC)	3 <sup>rd</sup> Quarter / Spring (Live)
TGOSC	<ul style="list-style-type: none"> <li>• Shift planning horizon</li> <li>• Validate emerging requirements</li> <li>• Review Training Readiness Assessments (TCOP)</li> <li>• AAR previous POM build</li> </ul>	<ul style="list-style-type: none"> <li>• Conduct SRTRA to prioritize / conduct trade space analysis</li> <li>• Provide guidance to TT PEG</li> <li>• Review POM Offsite input</li> </ul>	<ul style="list-style-type: none"> <li>• Refine SRTRA based on POM Offsite guidance and other emerging requirements</li> <li>• Review &amp; Approve PEG balance and risk</li> <li>• Review &amp; prioritize MYR UFRs</li> </ul>	<ul style="list-style-type: none"> <li>• Review emerging requirements for next POM</li> <li>• Review SLRF agenda and key topics</li> </ul>
SRP	<ul style="list-style-type: none"> <li>• Shift planning horizon</li> <li>• Approve Operational Demand Model for year D</li> <li>• Review Manning Guidance</li> <li>• Review Army Equipping / Modernization</li> <li>• Review Force Structure</li> <li>• Set conditions for Fall ASRC</li> <li>• Review select unit types</li> </ul>	<ul style="list-style-type: none"> <li>• Review ASRF / POM Offsite and hot topics</li> <li>• Approve Decision Support Template for year C / D</li> <li>• Determine RC additional readiness requirements above baseline training strategy</li> <li>• Recommend 10 USC 12304b requirements</li> <li>• Approve FY Readiness End states</li> <li>• Review select unit types</li> </ul>	<ul style="list-style-type: none"> <li>• Review select unit types</li> <li>• Update Decision Support Template</li> <li>• Recommend Readiness Objectives for SRTRA</li> <li>• Set conditions for Spring ASRC</li> </ul>	<ul style="list-style-type: none"> <li>• Update Decision Support Template</li> <li>• Review select unit types</li> </ul>

Figure 14-6. Training General Office Steering Committee Governance

**14-29. TGOSC Integration Forum.** The Integration Forum’s primary function is to prepare the TGOSC agenda by integrating supporting CoCs to ensure the presentations of recommendations are in the context of an Army-wide training and leader development requirement. The HQDA DCS G–3/5/7 Training Directorate Chief of Staff, or designated colonel / GS–15 level representative, chairs the Integration Forum. Integration Forum participants consist of the HQDA DCS G–3/5/7 Training Directorate Colonel / GS–15 chairs from each of the supporting CoCs. The HQDA DC, G–3/5/7 Training Directorate Chief of Staff may invite ACOM, ASCC, DRU, ARNG, USAR, selected Army Staff, and other representatives (subject matter experts (SME) when needed. The TGOSC chair will establish and provide guidance to supporting CoC, such as: Operations CoC, Mission CoC, Institutional CoC, and Training Support System CoC; other CoCs may be established as required; such as the Army Munitions Requirement CoC. The

## HOW THE ARMY RUNS

chairperson for each CoC will determine work groups as required based on TGOSC guidance, voting members for each CoC and publish a charter under which they will operate (approved by the Director of Training).

### **14-30. Senior Leader Readiness Forum (SLRF)**

The Senior Leader Readiness Forum (SLRF), formerly known as the Army Training and Leader Development Conference (ATLDC), is an annual senior leader forum that provides the CSA the opportunity to facilitate an informative dialogue among senior commanders and Army trainers on changes necessary to support Army training and leader development policies and resourcing matters. The SLRF focuses on current and future strategic training and leader development issues for the current and future warrior leader. Primary SLRF members are general officers responsible for training and leader development from each ACOM, ASCC, DRU, the ARNG, the USAR, Army Divisions, and Army Schools.

## **Section VIII**

### **Leader Development**

#### **14-31. Leader Development**

a. Leader development is the deliberate, continuous, sequential, and progressive process, grounded in Army values that grows Soldiers and Army Civilians into competent and confident leaders capable of decisive action. Leader development is achieved through the life-long synthesis of the knowledge, skills, and experience gained through the development of institutional, operational, and self-development. The Army Leader Development Model (see Fig 14-7) portrays the framework and its major components. The Army advocates seven leader development imperatives described in the 2013 Army Leader Development Strategy (ALDS) that guide policy and actions to develop leaders to meet the challenges of the 21<sup>st</sup> Century. The 2013 ALDS is available at: [www.usacac.army.mil](http://www.usacac.army.mil) or <http://usacac.army.mil/cac2/cal/repository/ALDS5June%202013Record.pdf>. These imperatives serve as guiding principles for the deliberate, continuous, and progressive process of developing leaders:

- (1) Commitment to the Army Profession, life-long learning, and development.
- (2) Balance the Army's commitment to the Training, Education, and Experience Components of leader development.
- (3) Manage military and civilian talent to both benefit the institution and the individual.
- (4) Select and develop leaders with positive leader attributes and proficiency in core leadership competencies for responsibility at higher levels.
- (5) Prepare adaptive and creative leaders capable of operating within the complexity of the operational environment and the entire range of military operations.
- (6) Embed mission command principles in leader development.
- (7) Value a broad range of leader experiences and developmental opportunities.

## Army Leader Development Model

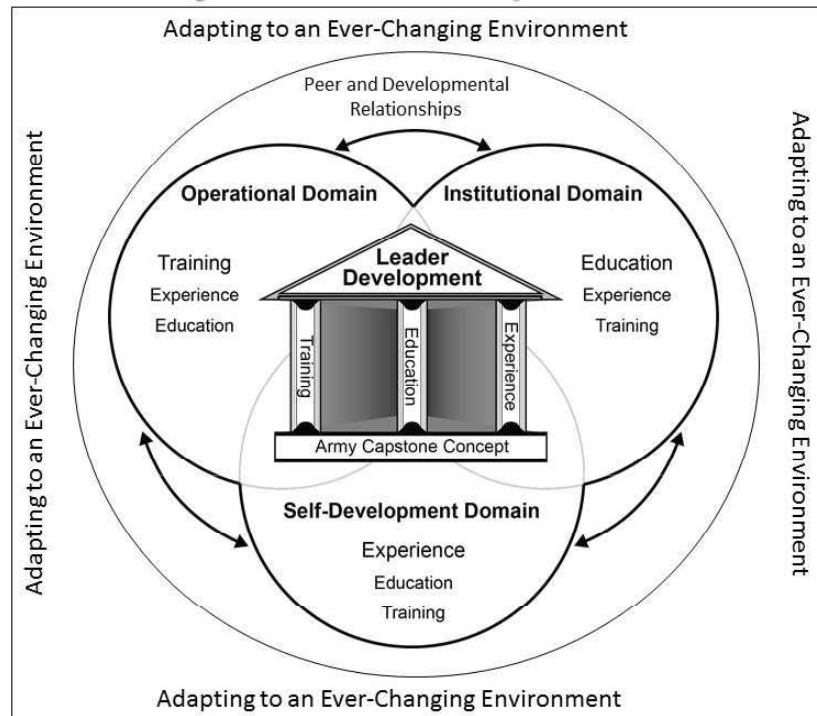

Figure 14-7. Army Leader Development Model

b. Professional Military Education (PME). PME is one element in the deliberate, continuous, sequential, and progressive process of developing leaders who demonstrate the Army's essential leader attributes and competencies and who are prepared to lead Soldiers.

(1) Noncommissioned Officer Education System (NCOES). The NCOES provides noncommissioned officers (NCO) with progressive and sequential leader, technical, and tactical training that prepares them to lead and train Soldiers, and execute unit missions (see Fig 14-8). The NCOES includes:

(a) Basic Leader Course (BLC) (formerly Warrior Leader Course); basic, branch-immaterial, leadership training.

(b) Advanced Leader Course (ALC); leader training and basic, branch-specific, squad, and platoon-level training.

(c) Senior Leader Course (SLC); advanced, branch-specific, platoon, and company-level training.

(d) Master Leaders Course (MLC); fills a gap between advanced and senior-level education focused on strategic, operational, and critical thinking; problem-solving; and effective communication (oral and written). (e) Sergeants Major Course (SMC); senior-level, branch-immaterial, staff training.

(f) Senior Leader Seminar (SLS); for CSM/SGM.

(g) Executive Leaders Course (ELC); for nominative CSMs for 1 to 2-star headquarters / agencies.

(2) Officer Education System (OES). The OES prepares officers and warrant officers (WO) for increased leadership, responsibilities, and performance at progressively higher levels. See Figures 14-9 and 14-10 for WO and officer development. The OES includes:

(a) Primary Level Education (2LT – CPT, WO1-CW3): Basic Officer Leader Course (BOLC) (e.g., BOLC A pre-commissioning / pre-appointment training to qualify to serve as officers and BOLC B officer initial entry and branch qualification training); WO Basic Course (WOBC) (e.g., BOLC A (pre-commissioning / appointment) and BOLC B (branch specific technical training); Captains Career Course (CCC) (e.g., tactical, technical, and leader knowledge and skills to lead company-size units and serve on battalion and brigade staffs); and WO Advanced Course (WOAC) (e.g., common core and branch-specific training that builds upon skills, knowledge, and experience).

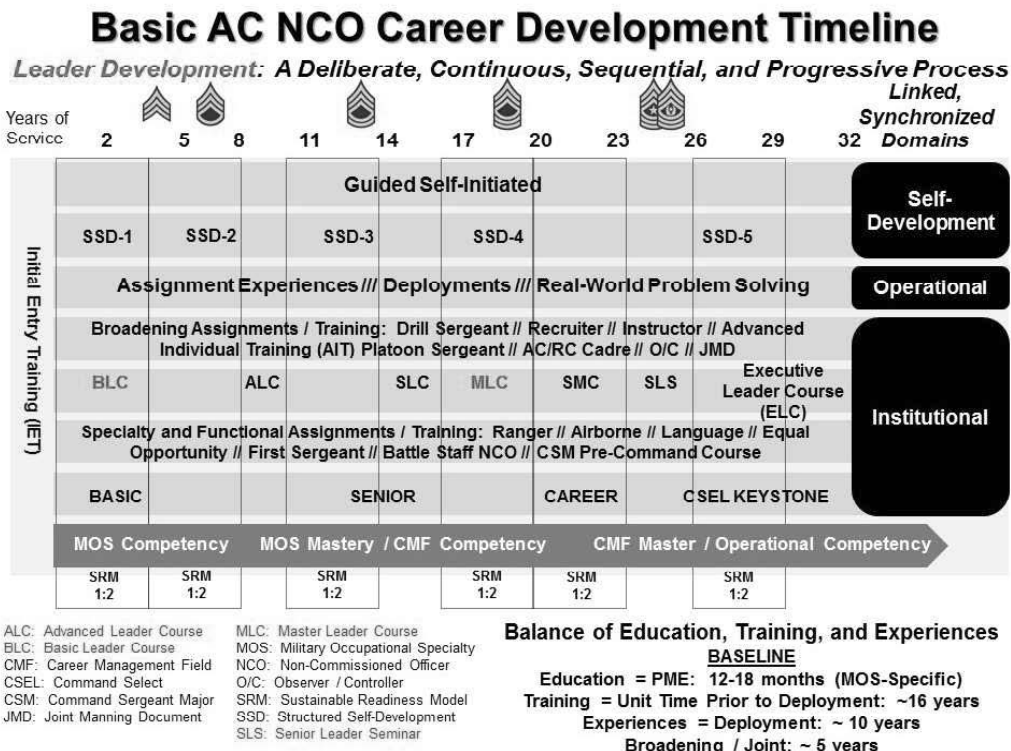

**Figure 14-8. Basic Active Component Non-Commissioned Officer Career Development Timeline**

(b) Intermediate Level Education (ILE) (MAJ, CW4): Command and General Staff Officer Course (CGSOC) (e.g., education and training to conduct decisive actions in a JIIM environment); WO Intermediate Level Education (WOILE) (e.g., branch-immaterial intermediate level staff officer and leadership skills); and School of Advanced Military Studies (SAMS) (e.g., advanced education in military arts and science for selected ILE graduates, preparing officers to plan and conduct future operations across the range of military operations).

(c) Senior Level Education (LTC – COL, CW5): Pre-Command Course (PCC) (e.g., command preparation that provides focused leader development opportunities for the Army’s future senior leaders); WO Senior Service Education (WOSSE) (e.g., capstone course for WO military education focusing on senior level staff officer and leadership skills required to serve at brigade and strategic levels); Army War College (AWC)—resident, distance education, and fellowships (e.g., educates and develops leaders for service at the strategic level while advancing knowledge in the global application of landpower); Senior Leader Seminar (SLS); and Advanced Strategic Leadership Studies Program (ASLSP) conducted at SAMS (e.g., develops theater-level leaders for positions of significant responsibility including strategic thinkers and planners at CCMD, Joint Task Force (JTF), and other four-star headquarters).

c. Self-Development. Self-development is planned, goal-oriented learning that reinforces and expands the depth and breadth of an individual’s knowledge base, self-awareness, and situational awareness. Self-development complements what has been learned in the classroom and on the job, enhances professional competence, and helps individuals meet personal objectives. There are three types of self-development:

(1) Structured Self-Development (SSD) is required learning that continues throughout a career and is closely linked to, and synchronized with, classroom and experiential learning, and is a prerequisite for attendance to NCOES courses. SSD is intended to bridge the operational and institutional domains and, by ensuring that learning is continuous and enduring, set the conditions for continuous personal and professional growth. SSD is a centrally managed set of specified content that must be completed within specified career points as a prerequisite for attendance at NCOES courses, but is both an individual and first-line leader responsibility. Soldiers become eligible for SSD upon completion of Basic Combat



Training / One Station Unit Training (OSUT), and subsequent completion of BLC, ALC, SLC, MLC, and SMC

## Warrant Officer Development Timeline

*Leader Development: A Deliberate, Continuous, Sequential, and Progressive Process*

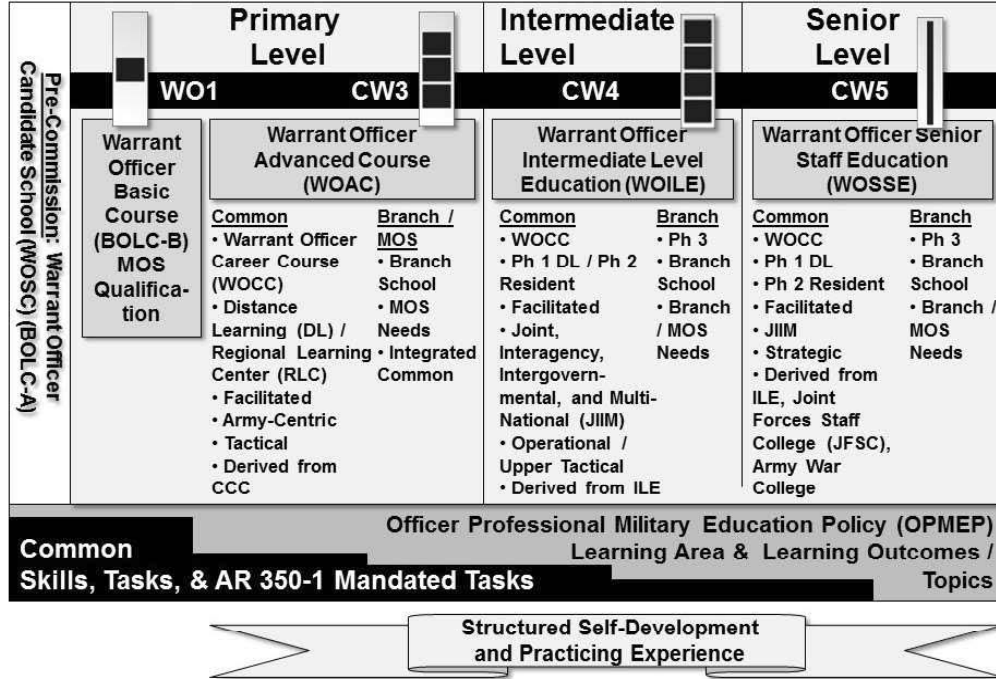

Figure 14-9. Warrant Officer Development Timeline

## Officer Development Timeline

*A Deliberate, Continuous, Sequential, and Progressive Process*  
(Ref: DA PAM 600-3, AR 350-1 and CJCSI 1800.01E)

Rank	Primary	Intermediate	Senior	General
Education Level				
Courses and Educational Institutions	Basic Officer Leadership Course (BOLC), Captains Career Course (CCC), Advanced Civil Schooling and Broadening Seminars	Army Cmd and Staff College, Sister Service Cmd and Staff Colleges, Joint and Combined Warfighting Course	Army War College, Sister Service War Colleges, National Defense University Colleges & Fellowships	Army Strategic Education Program – Basic, Advanced, Senior, CAPSTONE, PINNACLE, CJFLCC, etc.
Focus of Military Education	Assigned Branch Knowledge/Skills/Abilities, Staff Work, Intro to Joint Matters	Operational Warfighting, Intro to Theater Strategy Strategic Effects on Operations	Strategic Leader Dev, JIIM Ops, Cross-Domain ops at National Strategic Level	It Matters, National Security, Interagency Processes, Multinational Ops
Joint Emphasis	<b>Joint Awareness</b> Joint Warfare/Cross Domain fundamentals	<b>JPME Phase I</b> Nat Mil Capabilities, Cmd structure & Strat Guid, Jt Doctrine & Concepts, Jt and Multinat'l forces	<b>JPME Phase II</b> NSS, NMS, Jt Warfare, theater strategy in JIIM env, Nat'l & Jt planning processes, Design, Strategic Adaptability	<b>CAPSTONE</b> NSS, Jt Ops Art, Operating w/in Nat'l planning systems & Org, Leading/Influencing in JIIM environ.
Levels of War Emphasized and Jobs	<b>Tactical</b> Plt Ldr, CO XO, Bn and Bde Staff, Enterprise Functional jobs	<b>Operational</b> Bn & Bde S-3, Div, Corps & MACOM Staff Officer, Enterprise Functional Jobs	<b>Strategic</b> Bn & Bde Cdr, Div, Corps & MACOM Staff Officer, Enterprise Functional Jobs	ADC, Div & Corps Cdrs, MACOM Primary Staff Officers, Functional Leaders
Career Long Development	Leaders of Character Life-Long Learning Skills/Self-Development/Critical Thinking/Effective Communications Regional & Cultural Education: from awareness to competence			
Desired Attributes	1. Understanding Security Environment and Instruments of National Security 2. Anticipating and Responding to Surprise and Uncertain 3. Anticipating and Recognizing Change and Leading Transitions 4. Operating in Intent through Trust, Empowerment and Understanding 5. Making Ethical Decisions based on the Profession of Arms 6. Thinking Critically/Strategically and Applying Joint Warfighting Principles at all Levels of Warfare			

Figure 14-10. Officer Development Timeline

## HOW THE ARMY RUNS

(2) Guided Self-Development is recommended, but optional learning that helps keep personnel prepared for changing technical, functional, and leadership responsibilities throughout their career.

(3) Personal Self-Development is self-initiated learning where the individual defines the objective, pace, and process, such as pursuing college education and/or advanced degree programs.

d. Culture, Regional Expertise, and Language (CREL). Competent and confident leaders capable of decisive action must understand today's complex operational environment. While some specialties require leaders have language proficiency, all must be culturally aware and regionally informed to achieve mission success. This is why the Army includes elements of cross-cultural competency and regional understanding in both pre-deployment training and professional military education. Another key CREL function for the Army is DoD Executive Agent (EA) for the Defense Language Institute Foreign Language Center (DLIFLC). As DLIFLC EA, the Army is responsible for programming, resourcing, and providing foreign language training to leaders and specialists from all Services. This EA function can present challenges to the training enterprise. Although DLIFLC falls under the TT PEG like other TRADOC institutions, its funding comes from the Military Intelligence Program (MIP). Utilization must be managed in accordance with DoD directives governing MIP resources. Changes to DLIFLC funding require coordination thru HQDA, G-2 and approval from the Director of Training, DAMO-TR, HQDA G-3/5/7, in order to ensure compliance.

### Section IX Civilian Training and Leader Development

#### 14-32. Overview

Training and development of the Army Civilian Corps is required to sustain a mission-ready Army. 5 USC 4101 provides the authority to train Army civilian employees. Like their uniform counterparts, Civilian employees must be functionally proficient and technically competent leaders who are fully capable, adaptable, and committed to the Army's mission. Training and leader development is a shared responsibility between Army career program managers, supervisors and employees. Leaders are developed through a combination of training and education, and experience and self-development over the course of the civilian career. The professional attitudes and beliefs that characterize the Department of the Army Civilian are found in the Civilian Creed (ADRP 6-22).

#### 14-33. The Civilian Education System

The CES program is the Army's leader development program for all Army Civilians. It provides progressive and sequential education for Civilians at key positions throughout their careers. Courses of instruction are provided through blended learning - DL and resident instruction. CES courses are to be taken in sequence over a period of time as Civilians progress through their careers. HQDA G-37-TRV is the Army's proponent for CES. The Army Management Staff College, located at Fort Leavenworth, Kansas, executes CES. CES courses are the core leader development courses for most Army Civilians based on grade and equivalent pay band level as they progress through their careers. All course registration is completed through the Civilian Human Resource Training Application System (CHRTAS), a part of ATRRS. Each enrollee must establish a profile in order to register for all CES courses.

a. Responsibility. Commands are responsible for determining and forecasting their requirements for CES based on their civilian population. These requirements are entered into the TACITS on an annual basis for the future years. The commands attend the SMDR each year to validate their training requirements so they can be translated into quotas for the CES courses.

b. Registration. Registration for CES courses is done by employees in the CHRTAS. Command quotas are managed by the Command Quota Source Manager typically located in the G-1 or the G-3 of the organization. CES courses are centrally funded for most Army civilians. The prioritization of resident seats is: first, supervisors, managers and team leaders; second, non-supervisors, managers and team leaders; and third non-Army employees and military supervisors of civilians. Priority 3 employees must be funded by their command or organization. Detailed instructions and additional information can be found in AR 350-1.

c. Core Leader CES Courses.

(1) The Foundation Course (FC) goal is to provide Army civilians with an orientation to leader development concepts, build their careers and become an Army civilian leader. The course objectives are to: understand U.S. Army leadership doctrine; increase self-awareness as it relates to their profession; understand team building, group dynamics, and effective communication; assess individual values and how they relate to professional ethics; understand how to manage professional advancement and leverage career potential; and complete administrative requirements expected of Army civilians.

(2) The Basic Course (BC) develops Army civilians to lead small teams and manage projects. The BC is conducted through blended learning, DL, and two-week resident training. Resident training is taken after successful completion of the DL and takes place in a university setting encompassing a classroom environment and small group seminars. The BC is the required leader development course for all Army civilians in grades GS-01 through GS-09 or equivalent pay band.

(3) The Intermediate Course (IC) target population is mid-level leaders who by necessity are more agile, innovative, self-aware, and prepared to effectively lead and care for personnel and manage assigned resources. Training and developmental exercises focus on mission planning, team building, establishing command climate, and stewardship of resources. The Intermediate Course is conducted through blended learning - DL and three weeks resident training. Resident training is taken after successful completion of the DL and takes place in a university setting encompassing a classroom environment and small group seminars. The Intermediate Course is the required leader development course for all Army Civilians in grades GS-10 through GS-12 or equivalent pay band.

(4) The Advanced Course focus is on Army civilians skilled in leading a complex organization in support of national security and defense strategies; integrating Army and joint systems in support of the joint force; inspiring vision and creativity; implementing change; and managing programs. The Advanced Course is conducted through blended learning - DL and four weeks resident training. Resident training is taken after successful completion of the DL and takes place in a university setting encompassing a classroom environment and small group seminars. The Advanced Course is the required leader development course for all Army Civilians in grades GS-13 through GS-15 or equivalent.

(5) The Continuing Education for Senior Leaders (CESL) courses provide the continuing education sustainment program that brings senior level Civilian leaders together to discuss current and relevant issues facing the Army. The program intent is for leaders to return to CESL continuously (at least once a year) to refresh and update on current Army initiatives. The CESL course is conducted through blended learning - DL and four and a half days resident training. The DL consists of reading materials and written assignments. CESL resident training consists of both small and large group activities. The course structure is a combination of guest speakers and interactive exercises. It is open to Army civilians at the GS-14/15 or equivalent level, and active duty LTC, COL, CW4-5, and SGM.

(6) The Supervisor Development Course (SDC) is the Army's single source for providing mandatory supervisory training and refresher/sustainment training. The SDC is a web-based course with lessons that focus on supervising civilian employees and is required for all civilian and military personnel who supervise Army civilians. The SDC must be completed within the first year of placement in a supervisory position in accordance with the one-year supervisory probationary period. By law, supervisors are required to complete this course as refresher training every three years. SDC is available to all Army employees as a self-development tool.

(7) The Supervisor Development Course for Executives (SDC-EX) is required for experienced senior leaders (SES/GO) who have previously supervised Civilians. The purpose of this course is to meet the requirements of the NDAA 2010. This course is a guide and presents Army, DoD and OPM provisions those critical areas designated in the NDAA, including: merit systems principles / prohibited personnel practices; performance management; counseling, coaching, and mentoring; hostile work environment; valuing a diverse workforce; management and labor relations; and leader development and Civilian education system programs.

(8) The Action Officer Development Course (AODC) is a web-based course with a focus on "staff work" practices in the Army. Action Officer Development Course covers organization and management; conducting completed staff work; managing time and priorities; conducting meetings and interviews; solving problems and making decisions; communications; writing to the Army standard; coordinating; conducting briefings; and ethics. The AODC is a required course for all Army interns and completion is required for completion of the intern program. The AODC is available to all Army Civilians as a self-

## HOW THE ARMY RUNS

development tool. The course is available to military and Civilian employees to take at any point in their careers.

(9) The Manager Development Course (MDC) is a web-based course with lessons that focus on managing and leading people. The MDC includes modules in: organizational culture; time management; objectives and plans; problem-solving and decision-making; planning, programming and budgeting; manpower management; communications; information technology applications; the Army Environmental Program; equal employment opportunity; professional ethics; internal management control; and Army family team building. The Manager Development Course is available as a self-development tool for all Army employees and is recommended for Army Civilians in supervisory or managerial positions.

d. Competitive Professional Development (CPD).

(1) The CPD program is a planned, systematic, and coordinated program of professional development that supports the Army's organizational goals and mission. It encompasses functionally tailored developmental opportunities that occur in academic environments, business/industrial settings, or in other strategically planned career enhancing developmental assignments that have been identified in an approved Career Program Master Training Plan or IDP. Training instances may be short- or long-term and funded from various sources. Courses and programs are managed centrally at the Army Headquarters or funded by an individual's career program.

(2) Centrally managed courses include the Army Congressional Fellowship Program, Leadership for a Democratic Society at the Federal Executive Institute, Harvard University Program for Senior Executive Fellows, Senior Manager Course in National Security Leadership, Senior Leader Seminar, and Senior Leader Development Course. Academic Degree Training (ADT) is included in this category of professional development and central management. The proponent for these courses is the HQDA G-3/7 DAMO-TRV, Civilian Training and Leader Development Division.

(3) Career Program training, also referred to as civilian functional training, provides Army employees the opportunity to enroll in a planned and coordinated course or program of study in scientific, professional, technical, mechanical, trade, clerical, administrative, or other fields, which will improve individual and organizational performance and assist in achieving the Army's mission and performance goals. In addition to traditional classroom and online training, Career Programs also fund developmental assignments, training with industry, and academic degrees when they determine these opportunities are the most practical way to meet Career Program strategic workforce requirements.

(4) Civilian Training and Leader Development centrally managed programs are covered in AR 350-1. Career Program management is covered in greater detail in AR 600-950, Civilian Personnel Career Management. Career maps with training plans are found in the Army Civilian Training, Education and Development System (ACTEDS) and in Army Career Tracker. Career Maps are continuously updated by the Career Program managers to reflect ongoing career program development.

(5) All course enrollment for Career Program training and education, as well as all ADT, must be completed in GoArmyEd, an automated training application system. Each employee and supervisor must establish an account in GoArmyEd in order to apply for and approve training.

e. Senior Enterprise Talent Management (SETM). The SETM and ETM Programs are structured Civilian professional development system designed to meet the Army's long- term performance needs in a productive and efficient way. SETM and ETM are the means by which the Army prepares its Senior Civilians to assume duty positions of greatest responsibility across the Army. These programs are designed to afford selected GS-12-15 and equivalent Civilians an exceptional professional development, senior-level educational or experiential learning opportunity. The SETM and ETM Programs operates in accordance with the policy and procedures set forth in Army directive 2015-24 (Department of the Army Senior Enterprise Talent Management Program) under the overall supervision and oversight of the Assistant Secretary of the Army (Manpower and Reserve Affairs) (ASA (M&RA)) and will be executed by the CSLMO. The ASA (M&RA) and CSLMO will ensure that SETM complements and leverages other DOD and Army leader development programs and initiatives, while avoiding duplication. The SETM and ETM Programs are comprised of ten components: Enterprise Placement Program and Designation as an Army Enterprise Employee; Enterprise Placement Program Senior Executive Service Details; Project-Based SETM TDY Assignments; attendance at a SSC; attendance at the Defense Senior Leader Development Program; Army Senior Civilian Fellowships; Command and General Staff Officers Course; Executive Leader Development Program; Project-Based ETM TDY Assignments; and Leadership Shadowing Experiences.

f. Senior Service College (SSC). SSC is at the apex of the Army CES and prepares Army civilians for positions of greater responsibility in DOD. Army civilians in the GS-14/15 grades and equivalent levels are eligible to apply. SSC provides advanced-level educational opportunities for leaders who require an understanding of complex policy and operational challenges and increased knowledge of the national security mission. Attendance is a competitive process and selections are made by a HQDA SETM Board. SSC participants are moved from their organizational TDAs, assigned to the Civilian Personnel Training Account and required to sign the SSC / Graduate Placement Program (GPP) mobility agreement to be placed in a new permanent position. Placement will occur immediately after graduation. Participants are required to serve in the DOD a minimum of three times the length of the program.

g. DSLDP. The DSLDP is the premiere executive development program for senior defense civilians. The DSLDP provides joint leadership academic experience through: non-Army senior-level professional military education; defense-unique leadership seminars from an enterprise-wide perspective; and opportunities for individual development based on the participant's IDP. It is a 2-year program, including attendance at a sister service's resident SSC. Application for the DSLDP is through the SETM process. Army civilians in the GS-14/15 grades and equivalent levels are eligible to apply. DSLDP applicants who attend SSC during their program are moved from their organizational TDA, assigned to the Civilian Personnel Training Account and required to sign the SSC / Graduate Placement Program (GPP) mobility agreement to be placed in a new permanent position. Participants are required to serve in the DOD a minimum of three times the length of the program.

h. Enterprise Talent Management. The Enterprise Talent Management Program (ETM) is designed to provide board selected GS-12/13 and equivalent pay plan / band civilians professional and leader development opportunities. The program is operated under the supervision of the ASA (M&RA) and execution of the CSLMO. It consists of four components: Leadership Shadowing Experience; ETM-TDY Assignments; DOD Executive Leader Development Program; and CGSC.

i. Defense Executive Leadership Development Program (DELDP). DELDP is a unique and challenging opportunity for DOD employees to gain insight, training, and exposure to the missions and complex role of our war fighters. Participants train with each military service, as well as combined and allied forces around the world. Civilian employees at the GS-12/13/14 and equivalent levels are eligible to attend. For FY15, the DELDP is managed by HQDA G-37 Civilian Training and Leader Development Division. Execution of the program will move to the Senior Enterprise Talent Management Office in FY16.

j. Senior Executive Service (SES) Education, Training and Development. The Department of the Army SES members are the Army Civilian equivalent to general officers, and include top executive, managerial, supervisory and political appointment positions. The SES members are individuals who are highly agile and skilled in their function, who can successfully lead a wide spectrum of operations and who are adaptive to challenges. SES members demonstrate technical expertise, confidence, integrity, critical judgment and adaptability. Army Senior Executives can: operate in complex and fluid environments; build teams amid technological changes; provide vision and direction; and solve problems creatively. SES members require a broad core of executive qualifications or abilities in addition to professional, technical and program knowledge and skills. The Office of Personnel Management validated five executive core qualifications required of SES members: leading change, leading people, results driven, business acumen, and building coalitions. The Civilian Senior Leader Management Office (CSLMO), Office of the ASA (M&RA), provides centralized life-cycle management and administration for the Army SES personnel. The CSLMO plans, manages and executes the Army's SES Education, Training and Development Program with the advice and support of the Army's Executive Resource Board (ERB). The goal of the program is to foster a culture of continuous learning that enhances leadership competencies through education, training and experiences in department, joint, interagency, intergovernmental and multinational environments. The SES Education, Training and Development Program is comprised of: Mandatory Foundation Training, Position Based Training, Advanced Continuing Education, Joint Qualifying Training, Talent and Succession Management (TSM), and ERB results. The SecArmy TSM Board enables the Army's senior leadership to target SES members for competency enhancing developmental assignments. The TSM ensures that an Executive's potential is developed through career opportunities and that skills and talent are utilized to meet Army enterprise challenges, both today and in the future. The ERB may identify SES members for developmental assignments, reassignment or further education or training. ERB directed education or training takes precedence when prioritizing applicants for constrained course allocations.

## Section X Training Support

### 14-34. Training Support System

a. The TSS provides the foundation on which Army training runs. As described in AR 350-1, and ADP 7-0, it is the system of systems that provides networked, integrated, and interoperable training support capabilities that are necessary to enable operationally-relevant, JIIM training for Soldiers, units, and Army civilians anytime and anywhere. The TSS includes products (Instrumentation and Training Aids, Devices, Simulators and Simulations [TADSS]), services (training support operations and manpower) and facilities (ranges, simulation centers, mission training complexes, training support centers) that are necessary for creating the conditions to realistically portray the operational environment and enable training strategies. TSS enablers underpin the operational training strategies and institutional POIs by providing commanders with tools to execute Soldier, leader, MC, and unit collective training to standard at home station, CTCs, TRADOC Schools / CoEs, to include self-development.

b. The TSS consists of five primary programs that complement each other and together generate the Army's TSS capability. The programs include: Sustainable Range Program (SRP); MC Training Support Program (MCTSP); CTC Modernization (MOD) program; Soldier Training Support Program (STSP); and the Training Information Infrastructure (TII) program. Each TSS program is defined by supporting functions or components that may include program policy and procedures, manpower and TDA structure, modernization strategy, operations support functions and resources, connectivity, and management support systems.

(1) The SRP is the Army's approach for improving the design, management, use, and long-term sustainability of ranges. SRP is defined by its two core programs: first, the Range Program includes range modernization and range operations; and second, the Training Land Program focuses on land management and maintenance through the Integrated Training Area Management (ITAM) process, training land acquisition, and SRP Outreach, which provides support to both SRP core programs. ITAM provides a Geospatial Information System (GIS) capability to support range modernization, range operations, and ITAM.

(2) The MCTSP program provides the staff and trainers, facilities, infrastructure, and other resources necessary to support MC training of Army, USAR, and ARNG formations. The MCTSP provides virtual and constructive training environments in support of combined arms training that replicates Army operations across the spectrum of conflict. This program supports MC training for individuals and for units ranging from company to corps, and at levels from tactical to JTF, ASCC, and JFLCC levels of command. The MCTSP creates training that helps Army leaders develop current, relevant MC instincts and skills. It supports Army MC System (AMCS) training and battle command essential capabilities that empower individuals and small units and that allow junior leaders to prevail during decentralized operations. The MCTSP includes MC Training Capability operations and facilities, collective virtual and constructive TADSS, Army Games for Training (GFT), and Live, Virtual, Constructive (LVC) integration.

(3) The STSP includes individual Soldier through crew level virtual and live TADSS and Training Support Center (TSC) and Virtual Training Facility (VTF) operations. STSP manages TADSS fabrication of training devices, and the issuance of TADSS and provides instructors / operators for specific virtual TADSS and other TADSS support that enable commanders to execute individual and operational and institutional training.

(4) The TII program consists of two primary components: the Army Training Information System (ATIS); and point of delivery systems for Distance Learning (dL). ATIS includes the integration of Army training information systems and provides an integrating architecture for training management, scheduling, development and content management. Point of delivery systems maintain and upgrade home station, deployable and institutional systems and infrastructures.

(5) CTC MOD and life cycle technology refreshment of the maneuver CTCs (NTC, JRTC and JMRC) in support of changing Army doctrine includes OPFOR, instrumentation, TADSS, and facilities to provide a realistic training environment for BCTs in force-on-force and live fire scenarios. CTC MOD ensures CTCs remain relevant by providing joint context to the operational environment and provides the doctrinally-based feedback, facilitating leader and unit training dictated in the Army force generation training cycle. Resultant training capability output produces trained and ready combat units, leaders, and Soldiers prepared for the spectrum of conflict in a contemporary OE against a hybrid threat (WAS / CAM).

**14-35. Training Support System Governance and Management**

a. The DCS G-37 Training Simulations Division (DAMO-TRS) provides overall management and policy for TSS plans, programs, and resources. TSS governance is achieved through an enterprise consisting of HQDA G-37 TRS, TRADOC USACAC-Training and supported by PEO STRI and PEO EIS. TRADOC provides lead agent support, to include TSS requirements validation. The IMCOM garrisons execute TSS in coordination with the TSS Enterprise. The IMCOM HQ and regions oversee TSS execution in CONUS in support of the active component (AC) and USAR. Supported commands are FORSCOM, TRADOC, USARC, MEDCOM, USMA, and Military District of Washington (MDW). USAREUR, USARPAC, and the ARNG execute TSS on their installations and within the ASCC's AORs. The ACOMs, ASCCs, and DRUs that are responsible for operational and institutional training maintain a staff that validates and prioritizes TSS requirements for their subordinate commands.

b. Enterprise Organization. The organizations listed below represent the core of the TSS Enterprise and support DAMO-TRS in the following areas: policy development and dissemination; requirements development; integration validation and prioritization; resource allocation; and execution oversight and tasking.

(1) HQDA G-37 TRS provides Army-wide policy and resources.

(2) TRADOC training support for the Army and designates lead agents for TSS. It manages the TSS Master Plan and database, and provides analytical support capability.

(3) TCMs (e.g., live, virtual, constructive, gaming and integrating), aligned with, and across, the major TSS programs, identify program requirements and support the planning, programming, budgeting, development and acquisition of products, facilities, and services to the field.

(4) TRADOC Schools / CoEs develop requirements that support their institutional/school POI training, and, as a proponent, identify TSS requirements to support operational unit training.

c. Management Process. The TSS Management Process includes periodic Management Reviews (MR) to ensure TSS planning, programming, and execution is synchronized with current and future training needs. TSS Modernization Reviews and PMRs meet semiannually.

d. TSS Capability Assessment. The TSS undergoes continuous assessment to ensure capabilities support Army training strategies and the ACP.

(1) Assessment Metrics include:

(a) Mission Essential Requirements (MER) are products, services, facilities, and sustainment identified by the major TSS programs. The MERs define what is needed to support training strategies.

(b) Use Cases define the level of MER delivered to each location where TSS is executed. Each TSS major program sets the parameters by which use cases are determined.

(c) Bench Marks are derived from the ACP and reflect applicable PPBE cycles, normally by the FY in which the MER is required at each Use Case.

(d) The LIRA is used to manage the lifecycle of TADSS from a holistic approach over a 30-year period and seeks to synchronize requirement, acquisition and resource planning across the modernization, sustainment, training and installation communities.

(e) POM builds are accomplished through the TSS Short Range Training Requirements Analysis (SRTRA).

(2) Assessment Process entails:

(a) Major assessments conducted biennially to support POM development. They are done by conducting TSS Theater In-Process Reviews (IPRs) to determine TSS requirements based on the above metrics.

(b) Biennial ASCC / CMD level Theater IPR.

(c) Proponent Service Schools' annual TSS Reviews to determine broad functional approaches to TSS by battlefield function.

**14-36. Training Ammunition**

a. Training ammunitions requirements process.

(1) The Army develops munitions requirements in support of Army weapons training annually, by FY.

(2) Munitions resourcing is approved for all Army weapons training strategies through the AMRWG/COC process. Only munitions resourcing approved through the AMRWG/COC is published in DA Pam 350-38 and TRADOC POIs.

(3) The standard lead time to program for, procure, produce, and distribute munitions in support of a COC-approved weapons training strategy is a minimum of 4 years. It is imperative that munitions

resourcing strategies be presented to the AMRWG/COC early in the acquisition and training strategy development processes. Proponents may present a draft resourcing strategy once the initial development plan for a course has been approved, or, for new capabilities, as early as completion of MS A, the technology development phase.

(4) No later than 90 days following AMRWG/COC-approval of munitions resourcing for any weapons training strategy, TRADOC proponents will submit their approved strategy to the TRADOC Live Training Directorate STRAC Office, for review and forwarding to DCS, G-3/5/7 (DA G-37/TRA) (Training Ammunition Manager), for final validation and posting to TAMIS.

b. Home station training.

(1) DA Pam 350-38 provides commanders with the DCS, G-3/5/7-approved individual, crew, and collective weapons training strategies and identifies the munitions and TADSS resources required to execute the strategies. It provides the basis for determining unit training ammunition requirements. All weapons training strategies in DA Pam 350-38 are published and maintained in TAMIS. Chapter 1, glossary, and appendix A of DA Pam 350-38 will continue to be published through the Army Publishing Directorate (APD).

(2) Each TRADOC proponent school develops the Army-wide training strategies for all individual and crew certification training on individual and crew-served weapons for which it is the proponent.

(3) TRADOC schools that are the proponent for a collective training event will determine the collective training strategies for all crew-served weapons and weapons platforms involved in that training.

(4) TRADOC, with coordination and input from the commands that own a combined training center (CTC), is responsible for developing all weapons training strategies to support collective training at the CTCs. Strategies must include resourcing for opposing forces training support requirements and will use standard Army munitions.

(5) TRADOC proponent schools will develop all Army weapons training strategies in accordance with approved Army doctrine.

(6) ACOMs that have enduring (lasting 3 years or more) command-unique weapons training requirements will present strategies for those training requirements to the AMRWG/COC for approval. ACOMs must coordinate command-unique strategies with the appropriate TRADOC proponent school(s) prior to presenting the strategies in the AMRWG/COC for approval. Approved command-unique strategies will be included in DA Pam 350-38.

(7) DA Pam 350-38 is updated annually and officially published on 1 October in the FY of execution. Thus, the DA Pam 350-38 for execution in fiscal year 20x1 is published on 1 October 20x0.

(8) TRADOC proponents will explicitly identify and incorporate all TADSS into all weapons training tables where Army TADSS are part of the weapons training strategy.

(9) All units will use TAMIS to calculate their munitions requirements for home station and CTC weapons training. TAMIS extracts personnel and weapons densities information from the Army organization server (AOS), the DCS, G-3/5/7 (DA G-3/5/7) FM system of record for management of TOEs and/or TDAs. TAMIS pulls force data from AOS in accordance with appendix B. Unit authorization documents change continuously. Occasionally units will have TOE and/or TDA-authorized weapons and personnel on-hand that are not reflected in TAMIS (or vice versa). The munitions requirements for these on-hand, properly authorized weapons and personnel are valid requirements but must be manually entered into the TAMIS Requirements Module until the TOE and/or TDA data is updated in AOS and imported into TAMIS. To enable validation of these requirements, units will provide DCS, G-3/5/7 (DA G-37/TRA) a copy of the letter of acceptance (LOA) or the TOE and/or TDA that shows that the weapons or personnel are authorized to the unit.

(10) Units may have requirements that are "above-STRAC." These include requirements for non-enduring (fewer than 3 years) training events that are not in DA Pam 350-38. Units must manually enter these requirements in the TAMIS requirements module and provide justification to support their approval. Justification must include:

- (a) Name of the event.
- (b) A description of the event.
- (c) Frequency of the event.
- (d) Number of weapons in the event.
- (e) Number of rounds per weapon to support the event.
- (f) Why resourcing in DA Pam 358-38 is insufficient to support the requested training.



(11) Command ammunition managers are responsible for ensuring that only valid requirements are submitted to DCS, G-3/5/7 (DA G-37/TRA) for approval and resourcing. Commands will support above-STRAC and above-POI requirements with their existing authorizations, when possible.

**Section XI**  
**Policy, Requirements, and Resourcing Process**

**14-37. General**

The Training Program Evaluation Group (TTPEG) provides guidance, implements decisions and defends the resourcing for training readiness requirements within four portfolios (Operational Training, Institutional Training, Training Support Services and Operational Mission) in accordance with the Army Training Strategy and Army Senior Leadership guidance as directed. It plans, programs, manages, and defends the training resources that support the Army's ability to provide Training Readiness within the Programming, Planning, Budgeting, and Execution (PPBE) process. Input is provided by manpower models, force structure changes, and resourcing actions. Training activities receive Operations and Maintenance, Army (OMA) appropriation funds from Budget Activity 1 (Operating Forces), Budget Activity 2 (Mobilization), Budget Activity 3 (Training and Recruiting), and Budget Activity 4 (Administration and Service-wide Activities). Other contributing appropriations include the following: National Guard Personnel, Army (NGPA); Operations and Maintenance, ARNG (OMNG), Reserve Personnel, Army (RPA); and Operations and Maintenance, Army Reserve (OMAR).

**14-38. Organization**

The DCS G-3/5/7 combines the functions of institutional and unit training and training support. The DCS G-3/5/7 approves and manages Army military individual, collective, and modernization training and Army Civilian training and education programs. It provides the Army a single point of entry for issues which impact training. The DCS G-3/5/7 exercises HQDA supervision for defining concepts, strategies, resources, policies, and programs for Army training, education, and leader development. Other HQDA staff elements having direct or indirect impact on the training systems include:

- a. ASA (M&RA). ASA (M&RA) has a training division to assist in the development, implementation, and review of policies and programs related to achieving the Army goal of effective and efficient training and education for the Army. The ASA (M&RA) advises the SECARMY on all matters relating to human resources and reserve affairs, to include, readiness and training.
- b. ASA (FM&C). ASA (FM&C) formulates the Army budget, issues manpower and dollar guidance, distributes funds to commands and agencies, and monitors obligation rates and reprogramming actions.
- c. ASA for Acquisition, Logistics, and Technology (ALT). ASA (ALT) manages the life cycle of materiel and non-materiel items used by individuals and units in mission performance. The ASA (ALT) provides policy and guidance to research, develop, and procure system and non-system TADSS and other approved requirements for training support materials. Additionally, the ASA (ALT) funds and coordinates new equipment training (NET).
- d. ASA for Installations, Energy, and Environment (IE&E). ASA (IE&E) provides secretariat-level management for the formulation, execution, and review of policies, plans, and programs relating to the following: the Range and Training Land Program (RTLTP); environment, safety and occupational health concerns or requirements; the National Environmental Policy Act; and Land Use Requirements Studies.
- e. DCS G-1. The DCS G-1 is responsible for integrating personnel readiness and training, and manages ATRRS, the system that supports the ARPRINT management process. The DCS G-1 manages execution-year training program change requests driven by personnel readiness requirements through the TRAP. The DCS G-1 also manages the administration of the manpower requirements of the pre-commissioning programs for officers (USMA, ROTC, and Officer Candidate School (OCS)); and training for equal opportunity, and alcohol and drug abuse (see Chap 12 and Chap 13).
- f. Human Resources Command (HRC). The AHRC projects training requirements, by FY based on training spaces allocated by the G-3/5/7 for AC officers and enlisted personnel. The DCS G-3/5/7 allocates training spaces for AC based on projected unit requirements and distribution policies informed by the Army force generation cycle.

g. HRC-Army Reserve (AR). HRC commands and controls all Individual Ready Reserve (IRR) members. HRC also provides individual training management to the IRR, officers and enlisted (see Chap 6). It is responsible for the Officer Professional Management System (OPMS)-USAR and the Enlisted Professional Management System (EPMS)-USAR, and projects officer and enlisted training requirements for the USAR by FY. The HRC allocates training spaces for USAR officers and enlisted based on projected training requirements and in accordance with applicable Army force generation cycles.

h. Assistant Chief of Staff, Installation Management (ACSIM). ACSIM provides the following: policy and guidance for facility engineering programs and environmental compliance, restoration, pollution prevention, conservation, environmental program management, and real property master planning; direction and assistance in land acquisition in support of the RTLP; utility and manpower infrastructure facility support for installation Training Support Centers (TSC) operations.

i. DCS G-2. The DCS G-2 is responsible for the OPFOR program and assisting the DCS G-3/5/7 on intelligence training policy and management of the Defense Foreign Language Program.

j. DCS G-4. The DCS G-4 is responsible for logistics readiness of Army forces, to include supportability/maintainability of equipment (to include training assets) in troop units (Chapter 12).

k. The Army Chief Information Officer (CIO) / G-6. The CIO / G-6 provides policy and procedural guidance for Army visual information and multimedia support.

l. The Inspector General (IG). The IG conducts Army-wide assessments of training development and training management to evaluate the implementation of training policy and impacts of training on readiness, sustainability, and units' ability to fight and win. Assessments focus on training resources and provide feedback to commanders in order to promote efficiency in training.

m. Office of The Surgeon General (OTSG). The OTSG projects training requirements and allocates course spaces internal to the Army Medical Department (AMEDD).

n. Chief, National Guard Bureau (CNGB). The CNGB promulgates training policy for ARNG units through ARNG Regulation 350-1. The CNGB also programs the resources for ARNG training and allocates training spaces to each state, territory, and the District of Columbia. ARNG unit commanders are responsible for their units' training. FORSCOM establishes training criteria and supervises training of ARNG units. Policy and guidance are contained in FORSCOM / ARNG Regulation 350-2.

o. Chief, Army Reserve (CAR). The CAR programs training resources for the USAR and monitors USAR training activities. The CAR manages professional development training for USAR officers, WOs, and senior NCO through HR (Chapter 7).

### 14-39. Requirements and Resourcing Process

a. Training (TT) Program Evaluation Group (PEG). As one of the Army's six Title 10 PEGs, the TT PEG in coordination with the Training Enterprise, Integrators and Stakeholders program, resources across the Five Year Defense Plan (FYDP).

b. Management Decision Packages (MDEP). The TT PEG manages all aspects of training dollars within components, individual through unit. The TT PEG has MDEPs divided into four portfolios: Operational- Collective Training, Institutional Training- Individual and Leader Development, Training Support Systems- Training Enablers and Mission Supports Missions, Cyber, and Network operations. The Deputy Director of Training, ODCS, G-3/5/7 and the ASA (M&RA) co-chair the TT PEG. MDEP managers articulate and defend resource requirements to the PEG during the POM. The MDEP managers use various costing models to determine and create requirements. NN

c. Planning, Programming, Budget and Execution (PPBE). The PEG uses the PPBE process to build the Training PEGs portion of the Army's Program Objective Memorandum (POM). A variety of systems and models provide input into this process such as the manpower model, force structure model, training models, costing models and resourcing actions. Figure 14-11 depicts how training fits into the PPBE process battle rhythm for FY18.

## Training Input to the PPBE Process

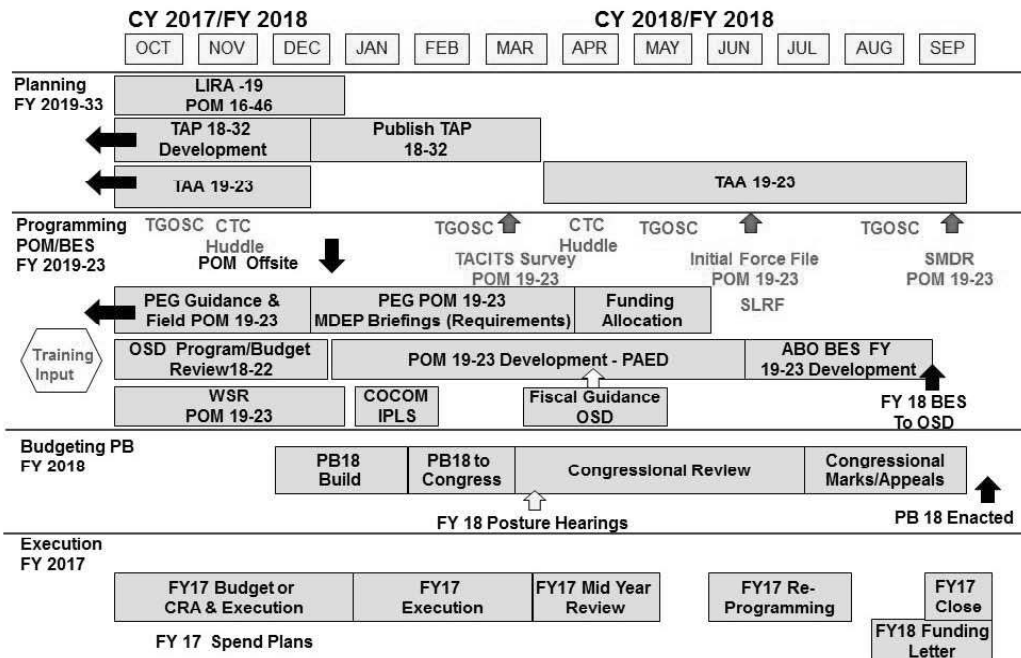

Figure 14-11. Training Input to the PPBE Process

### Section XII Summary and References

#### 14-40. Summary

All training and leader development actions occur within the Army culture which embraces values and ethics, the Warrior Ethos, standards, and enduring principles and imperatives. Army training consists of three domains: operational; institutional, and self-development. Army training strategies serve to synchronize the role each training domain plays in building force readiness. Training builds confidence and competence, while providing essential skills and knowledge. Training results in unit readiness. Unit commanders are responsible for scheduling and conducting training. Leader development is the deliberate, continuous, sequential, and progressive process founded in Army values that grows Soldiers and Army Civilians into competent and confident leaders capable of decisive action.

#### 14-41. References

- a. Publications—
  - (1) Army Doctrine Publication (ADP) 3-0. Unified Land Operations, Oct 2011.
  - (2) ADP 7-0, Training Units and Developing Leaders, Aug 2012.
  - (3) Army Doctrine Reference Publication (ADRP) 3-0, Unified Land Operations, May 2012.
  - (4) Army Leader Development Strategy 2013.
  - (5) Army Regulation (AR) 5-13, Total Army Munitions Requirements Process and Prioritization System, Dec 2009.
  - (6) AR 12-15, Joint Security Cooperation, Education and Training, Jan 2011.
  - (7) AR 25-1, Army Information Technology, Jun 2013.
  - (8) AR 25-30, The Army Publishing Program, Jun 2015.
  - (9) AR 220-1, Army Unit Status Reporting and Force Registration, Apr 2010.
  - (10) AR 350-1, Army Training Leader Development, Aug 2014.
  - (11) AR 350-2, Operational Environment and Opposing Force Program, May 2015.
  - (12) AR 350-10, Management of Army Individual Training Requirements and Resources, Sep 2009.

## HOW THE ARMY RUNS

- (13) AR 350-19, The Army Sustainable Range Program, Aug 2005.
  - (14) AR 350-38, Policies and Management for Training Aids, Devices, Simulators, and Simulations, Mar 2013.
  - (15) AR 350-50, Combat Training Center Program, Apr 2013.
  - (16) AR 525-29, Army Force Generation, Mar 2011.
  - (17) AR 600-100, Army Leadership, Mar 2007.
  - (18) AR 600-8-19, Enlisted Promotions and Reductions, Feb 2015.
  - (19) AR 600-8-29, Officer Promotions, Feb 2005.
  - (20) Army Training Strategy, Oct 2012.
  - (21) DA Pamphlet (Pam), 350-38, Standards in Training Commission, Oct 2014.
  - (22) DA PAM 600-3 Commissioned Officer Professional Development and Career Management, Dec 2014
  - (23) DA PAM 600-25, U.S. Army Noncommissioned Officer Professional Development Guide, Sep 2015.
  - (24) Draft Army Training Strategy April 2015.
  - (25) Rivera, Francis A., CP26, "Investing in Force Management," Manpower and Force Management Career Program Bulletin, spring 2014, pp 10-11.
  - (26) TRADOC Regulation 350-18, The Army School System (TASS), Jul 2010.
  - (27) TRADOC Regulation 350-70, Systems Approach to Training Management, Processes, and Products, Mar 1999.
  - (28) The U.S. Army Training Concept 2012-2020, 23 Nov 2010.
  - (29) The U.S. Army Learning Model for 2015, 14 Sep 2010.
  - (30) DODD 5160.41E Defense Language, Regional Expertise, and Culture (LREC) Program dated 21 Aug 2015
  - (31) DODD 5205.12 Military Intelligence Program (MIP) dated 14 Nov 2015
  - (32) DODI 5160.70 Management of the Defense Language, Regional Expertise, and Culture (LREC) Program dated 30 DEC 2016
  - (33) AR 11-6 Army Foreign Language Program dated 18 Feb 2016
  - (34) AR 350-20 Management of the Defense Foreign Language Program dated 15 Mar 1987
- b. Useful Links—
- (1) <http://tradoc.army.mil>.
  - (2) <http://apd.army.mil>.
  - (3) <http://dls.army.mil>.
  - (4) <https://www.atn.army.mil>.
  - (5) <https://www.atrrs.army.mil>.
  - (6) <http://usacac.army.mil>.
  - (7) <https://www.us.army.mil/suite/portal/index.jsp>.
  - (8) [www.dliflc.edu](http://www.dliflc.edu).

## Chapter 15

### Information Management and Information Technology

#### Section I Introduction

##### 15-1. Chapter Content

This chapter provides an executive overview of how the Army conducts business regarding information management (IM) and information technology (IT). The key concepts are: the IM and IT roles and responsibilities of the Chief Information Officer (CIO) / G-6; Army network strategy; Army enterprise management; and partnerships with the CIO / G-6. The last section of this chapter provides a list of key terms and references.

##### 15-2. Chief Information Officer / G-6 Roles and Responsibilities

The CIO / G-6 is a senior Army official with dual roles regarding Army business for IM and IT. The duties and responsibilities of the CIO role differ in scope and authority from the duties and responsibilities of the G-6 role. The next two sections will separately describe the duties and responsibilities of the Army CIO and the G-6.

##### 15-3. Chief Information Officer Duties and Responsibilities

The CIO is the principal adviser to the Secretary of the Army (SECARMY) on the strategy, policy, and execution of IM and IT for the Army. The CIO is also responsible for: advising the SECARMY on the effect of IM and IT on warfighting capabilities; creating enterprise architecture; developing information sharing policy; maintaining Army resource management processes; and ensuring the synchronization of the Army's network activities. This chapter organizes these responsibilities into four main categories: Strategy / Policy; Standards / Architecture; IT Financial Management; and Implementation Oversight.

- a. Strategy / Policy.
  - (1) Develop Headquarters, Department of the Army's (HQDA) IM strategy.
  - (2) Develop and implement the IM and IT capital planning and investment control strategy.
  - (3) Establish strategic direction for aspects of the Planning, Programming, Budgeting, and Execution (PPBE) for IM resources.
  - (4) Develop IM policies and guidance that are in compliance with laws.
  - (5) Set policy for the acquisition of IM, IT, and information resources to maximize the value of IT investments.
  - (6) Develop policy for information sharing standards.
  - (7) Develop policies and guidance for Army cybersecurity activities including key infrastructure, common access card, and other technology programs.
  - (8) Coordinate with and provide input to the Chief Management Officer's (CMO) strategic guidance on business operations, policy development, procedures, and planning documents to obtain alignment and integration with IM and IT data strategies and directives.
- b. Standards / Architecture
  - (1) Develop, implement, and maintain the Army's IT enterprise architecture.
  - (2) Develop information sharing standards and architecture.
  - (3) Develop cybersecurity standards and architecture.
- c. IT Financial Management.
  - (1) Review budget requests for all IT national security systems.
  - (2) Promote the effective and efficient design and operation of all major information resources management processes.
  - (3) Report the Army's IT budget to Congress.

## HOW THE ARMY RUNS

### d. Implementation Oversight.

- (1) Develop, coordinate, and implement an assessment process for Army IM programs, including compliance with IM policies, guidance, standards, and monitoring.
- (2) Advise and assist the Assistant Secretary of the Army (Acquisition, Logistics and Technology) (ASA (ALT)) on the acquisition of IM, IT, and information resources in order to ensure that IT resources are acquired and managed in a manner that implements the policies and procedures defined by the CIO.
- (3) Chair the Army CIO Executive Board (EB) and represent HQDA on IM issues and concerns.
- (4) Develop, implement, and maintain infrastructure and portals.
- (5) Supervise the execution of information sharing standards.
- (6) Supervise the execution and compliance with cybersecurity requirements.
- (7) Conduct IT portfolio management by identifying opportunities, validating requirements, screening business cases, providing guidance on and monitoring implementation of IM capabilities and dependencies in business process initiatives and programs.
- (8) Conduct IT investment performance management and advise the SECARMY regarding continuing, modifying, or terminating an IM or IT program or project.
- (9) Ensure that HQDA has a sufficient number of trained information resource management and information security personnel and make sure those personnel meet requirements for ensuring the performance of goals established for information resource management.
- (10) Ensure that IT and national security systems are in compliance with standards of the Federal Government and Department of Defense (DOD).

### 15-4. Deputy Chief of Staff, G-6

The Army Signal, DCS, G-6, function is fulfilled by providing advice to the Chief of Staff, Army (CSA) for IM / IT and communications issues and their impact on warfighting capabilities from a network functional perspective. G-6 responsibilities are organized into four main categories: Strategy / Policy; Standards / Architecture; Resource Management; and Implementation Oversight.

#### a. Strategy / Policy.

- (1) Develop the Army network strategy.
- (2) Develop strategy and policy for—
  - (a) Information and signal operations.
  - (b) Army signal force structure.
  - (c) Equipping and employment of signal forces.
- (3) Provide policy and guidance for the Army's communications needs for all network layers, including Top Secret and higher levels of security and access to coalition networks.

#### b. Standards / Architecture.

- (1) Develop, implement, and maintain Army network architecture.
- (2) Develop reference architectures to standardize solution procurement.

#### c. IT Financial Management.

- (1) Formulate and defend resources necessary to provide command, control, communications, and computers (C4) and IT solutions to the warfighter.
- (2) Translate warfighter IM, IT, and information resources requirements into funding requirements.
- (3) Resource the Army's communications needs for all network layers, including Top Secret and higher levels of security and access to coalition networks.

#### d. Implementation Oversight.

- (1) Develop, coordinate and implement an assessment process for Army communications programs, including compliance with IM policies, guidance, standards, and monitoring.
- (2) Assess the effects of IM-related strategy, policies, plans, services, and programs on the warfighter.
- (3) Monitor the implementation of IM requirements.
- (4) Guide and monitor the implementation of the Army global enterprise network.
- (5) Execute the Army's data and information sharing plan.
- (6) Implement CIO policy and guidance for Army cybersecurity activities.
- (7) Supervise Army-wide activities in C4, satellite-enabled information networks, enterprise-wide integration of Army information and IT, and IM-related aspects of business continuity, disaster recovery, and contingency support.

(8) Supervise the implementation of other Army-wide communications programs, including those for Army spectrum management, non-intelligence space and joint military satellite communications programs and projects, and visual information.

(9) Act as the Enterprise Information Environment Mission Area (EIEMA) lead for the functional area of communications, and conduct IT portfolio management by identifying opportunities, validating requirements, screening business cases, providing guidance on, and monitoring implementation of IM capabilities and dependencies in business process initiatives and programs.

## Section II Army Network Strategy

### 15-5. The Army Network and LandWarNet

The Army network, also called LandWarNet, is comprised of operational, enterprise, and installation communications, computing, network operations, and security components. The Army's network must be capable, reliable, and trusted. To meet these requirements the Army's network must be a single, secure, standards-based environment that ensures access at the point of need and enables global collaboration.

a. The CIO / G-6 leads the Army's network modernization effort which will deliver timely, trusted, and shared information. The CIO / G-6 mission includes creating an environment where innovation and service empower Army and mission partners through an unsurpassed responsive, collaborative, and trusted information enterprise.

b. Network Modernization. The network must be treated as a single entity, unified from the DOD Information Network (DODIN) to the installation and to the farthest tactical edge. It must provide the same basic solutions both to the home station and to the dismounted Soldier in theater. The ultimate goal is to enable mission command (MC), which empowers formations with unmatched lethality, protection, and situational awareness to achieve tactical dominance. Achieving tactical dominance requires an overarching network architecture that connects all echelons from squad through Joint Task Force (JTF) to ensure that leaders have the right information at the right time to make the best possible decisions. The Army must design, develop, acquire, and field the network in a comprehensive, synchronized manner. The Army's CIO / G-6, in coordination with ASA (ALT), will modernize the network through Information Technology Management Reform (ITMR) Data Center Consolidation and Standardization, and Application / System Rationalization and Migration initiatives that will achieve significant efficiencies and cost savings. The reforms will support the vision of a single, secure, standards-based network that aligns with the Joint Information Environment (JIE).

c. End-to-End Capability. The Army network, LandWarNet, is comprised of operational, enterprise, and installation communications, computing, network operations, and security components. Over the last decade, the Army invested heavily in augmenting and integrating LandWarNet operational solutions. During this same period, the enterprise and installation components of the network have remained relatively stagnant, fostering significant disparities. As the Army shifts to a CONUS-based fighting force, the requirement to train with the same technology and procedures used in theater, and the requirement for a smaller footprint in the area of operations, mandate transformation of LandWarNet's institutional components. The Army must rebalance LandWarNet into an end-to-end network while maintaining readiness, guaranteeing interoperability, and minimizing cost.

d. Network 2020 & Beyond. Following the successful capability set approach used in the MC domain, the Army will incrementally upgrade the institutional component of LandWarNet while synchronizing solutions with the operational network. These upgrades, often transparent to end users, will provide significant service improvements for Army leaders, data center operations, network users, and network operators, while enhancing the security posture of the network. Network 2020 & Beyond will increase effectiveness (e.g., single sign-on access to applications and data repositories, and robust and always available collaborative solutions), efficiency (e.g., command and control (C2) of the network through centralized network operations and synchronized network funding), and security (e.g., assured identity and access management, and continuous monitoring and risk assessment of the network and data center security posture).

### 15-6. Network Transformation

The Army's Network Campaign Plan (ANCP), supports the Army Campaign Plan (ACP) and the Army Operating Concept (AOC). The ANCP supports mission readiness by providing the vision and direction that set conditions for and lay a path to Network 2020 and Beyond by unifying efforts to provide a modern network that meets the Army's warfighting and business needs, today and tomorrow. The ANCP is updated annually and is comprised of three documents which are intended to be used together to achieve the overall vision. The first is an overarching document that supports The Army Plan (TAP) by establishing priorities and focused efforts as Army IT stakeholders execute their roles and responsibilities. The ANCP Implementation Guidance, Near-Term describes execution activities and reflects the changing realities of Army budget, acquisition, resources, and mission. The ANCP Implementation Guidance, Mid-Term charts network modernization from a capabilities perspective in order to guide resource planning and shape the Program Objective Memorandum (POM).

a. Network Capability Sets (NCS). The Army will use a capability set management construct for the network that will cut across functional areas. To realize the full operational capabilities of LandWarNet 2020 and Beyond, it is essential that NCS integrate operational and institutional requirements defined as Operational Capability Sets (OCS) and Institutional Capability Sets (ICS) respectively. OCS are defined as MC hardware, applications, communication transport, and services that support units and organizations while deployed. ICSs are defined as the hardware, applications, services, and communications transport that support the Army business, installation management, and Army units and organizations. The ICS supports both Generating Forces (GF) and Operating Forces (OF) as they train, prepare to deploy, and deploy. The OF receive responsive support, while en route and forward deployed, from solutions resident across various Army / DOD installations.

b. Lines of Effort (LOE). The CIO / G-6 executes the duties and responsibilities of the offices via specified LOE. The LOE are defined in the ANCP.

## Section III

### Army Enterprise Management

### 15-7. Standardizing Enterprise Information Technology Management

The Army is moving toward LandWarNet 2020 and the JIE. As it moves toward this holistic enterprise concept, the CIO / G-6 synchronizes requirements and delivers solutions to the enterprise, ensuring LandWarNet 2020 provides capability to the edge. As solutions are delivered, the Army collapses local systems and delivers enterprise services bringing the full complement of LandWarNet to the edge.

### 15-8. Army Information Technology Governance

The Army CIO / G-6 hosts two primary governance boards that support both the CIO and G-6 responsibilities: the CIO EB; and the CIO / G-6 Army Enterprise Network Council (AENC).

a. The CIO EB serves as a platform to share Army CIO / G-6 strategies, policies, actions, and guidance with Army Commands (ACOM), Army Service Component Commands (ASCC), Direct Reporting Units (DRU), and HQDA, as well as receive feedback and questions from the field. In addition, the CIO EB is a platform used to socialize and discuss the AENC decisions. Board membership consists of General Officers, Senior Executive Service, and other senior-level participants from the Army Staff (ARSTAF), ACOMs, ASCCs and DRUs.

b. The AENC is chaired by the Army CIO. The AENC serves as a senior decision-making forum for the CIO and G-6 functions, ensuring that the strategic objectives of Army EIEMA support DOD's JIE. The AENC ensures that validated requirements are traceable to and fully support the required capabilities of the Warfighting Mission Area (WMA) and Business Mission Area (BMA). The AENC is a three-tiered structure with two subcommittees: a 1/2-Star Council; and a Council of Colonels. The AENC provides strategic guidance and enables the operational solutions of, and recommends decisions, encompassing three areas: network security; Army Core Enterprise Services; and building network capacity. The AENC conducts portfolio reviews in order to align requirements with the PPBE process. During the portfolio reviews, portfolio managers will validate requirements against adherence to and compliance with strategic priorities, architecture integration, Clinger-Cohen Act (CCA) criteria, capability gap and / or redundancy analysis, cost-benefit analyses, and / or other criteria. These reviews will inform processes such as Joint



Capability Integration and Development System (JCIDS), Defense Acquisition System (DAS), or other processes for appropriate action.

## **15-9. Command, Control, Communications, Computers / Internet Technology Investment Strategy**

The efficient and effective use of IT resources has a direct effect on the Army's ability to perform its missions. The Army CIO / G-6 manages IT investments and develops a coordinated, consolidated investment strategy across all Mission Areas. The IT planning process develops the IT Investment Strategy, recommending a prioritized list of IT investments and / or whether to continue, modify, or terminate an IT program / project in accordance with CCA Authorities (U.S.C. Titles 10, 40, and 44). The recommended prioritization listing is both a reference tool and support tool within Program Evaluation Groups (PEG) throughout the PPBE and acquisition processes. The prioritization process addresses capability gaps, investment risks, IT interdependencies, and timing issues across all areas of IT investments. This helps the Army maximize how limited IT investment funding is used and ties investments to strategic priorities.

## **15-10. Core Enterprise Services**

The EIEMA is focused on delivering core enterprise services to the end-users of the Warfighting, Business, and Intelligence Mission Areas supporting both the current and future force. Enterprise services allow the widespread use of standardized solutions (e.g., services, tools, or applications) to facilitate end-to-end linkage of the Army's operational and institutional processes. The CIO / G-6 is responsible for overseeing the Army's integrated approach to delivering Enterprise services. CIO / G-6 integrates plans, policy, and resources to ensure the business and warfighting requirements of the Army are met. Enterprise services provide an array of critical enablers for executing the Army's mission. These include general-use services, services for specific functional communities, and services to support Army missions in Joint, Interagency, Intergovernmental, and Multinational (JIIM) environments.

a. CIO / G-6 serves as an integrator for enterprise services while ensuring compliance with applicable law, federal, DOD, and joint guidance. The CIO is required by statute to perform management, integration, and accountability for use of IT resources in performing Army missions and functions. Consistent with the LandWarNet 2020 & Beyond strategy, the Army will deploy enterprise services as a part of capability set fielding.

b. The Army's network modernization efforts include investments in enterprise services that support implementation of the JIE. Managing IT solutions as enterprise services reduces the total cost of ownership through bulk buying capacity and reduces security risks related to managing multiple individual solutions. Modernization investments include enterprise email, enterprise content management, and collaboration services, and enterprise resource planning investments such as the General Fund Enterprise Business System (GFEBS).

## **15-11. Army Enterprise Service Management Framework**

a. The AESMF is the IT service management (ITSM) model the Army CIO / G-6 has implemented to help guide the design, implementation, and maintenance of quality enterprise services for Army customers. This requires integration with other Army management processes, such as JCIDS and PPBE. The AESMF is a process-based approach for delivering enterprise IT services aligned with Army's strategic and operational goals. Based on industry best business practices, AESMF is aligned with both the Defense Enterprise Service Management Framework (DESMF) and the DOD Directive (DODD) 8000.01, Management of the Department of Defense Information Enterprise.

b. AESMF relies on people, processes, functions and technology to effectively deliver IT services within a well-defined governance structure. Currently the AESMF applies to all IT services listed in the Army C4 and Information Management (C4IM) Services List. Following the AESMF lifecycle approach (e.g., Strategy, Design, Transition, Operations, and Continual Service Improvement) will provide the Army with effective, secure, and efficient IT services that meet Army operational mission requirements. Further information about Army Enterprise Service Management (AESM) is found in the AESM Concept of Operations (CONOPS), and the AESM Reference Architecture.

## **15-12. Army Enterprise Architecture Overview**

Army Enterprise Architecture (AEA) refers to either an architecture description or an architecture implementation. As an architecture description defined in DOD Architecture Framework (DOD AF) 2.0,

the AEA provides a representation of a current or future real-world configuration of resources, rules, and relationships. Once the representation enters the design, development, and acquisition portion of the system development life cycle process, the AEA is transformed into real assets in the field. The AEA Framework supports this transformation process. The AEA—

- a. Provides policy and guidance governing the composition and use of architecture documentation within the Army and unique architecture responsibilities. Information about Army architecture can be found at [http:// architecture.army.mil](http://architecture.army.mil).
- b. Is used to analyze operational concepts and systems and to support new capabilities and requirements as required by the following: Chairman of the Joint Chiefs of Staff Instruction (CJCSI) 3170.01, JCIDS; the DOD 5000 series of acquisition documents; Information Support Plan (ISP) process; and other authorities.
- c. Supports the key requirement and solution development processes of JCIDS in the following: WMA; Business Capability Lifecycle (BCL) in the BMA; and NSC fielding in the EIEMA.
- d. Defines the mission, the technologies necessary to perform the mission, and the transition processes for implementing new organizations, processes, and technologies in response to changing mission needs.
- e. Assists in driving the Army's IT investment strategy by providing the right data in useable formats to decision makers to address capability gaps, investment risks, interdependencies, and alignment with key Army and Joint doctrine.
- f. Supports the requirements definition, design, development, acquisition and fielding of the network in a comprehensive and synchronized manner.
- g. Supports acquisition, implementation, and management of integrated and interoperable systems that enable the delivery of required operational capabilities in support of full spectrum operations.
- h. Provides the foundation for Army IT transformation by providing the information needed for data-driven decision making as relates to the current and future state LandWarNet. The AEA will also provide the necessary information to the CIO / G-6 to track progress on ITMR implementation and the related efficiencies, cost savings, and avoidances.
- i. Depicts the end-to-end architecture connecting the force from squad to JTF, to ensure our leaders have the right information, at the right time, to determine the best course of action for a given mission.

(1) AEA Composition. The AEA describes all aspects of the Army enterprise. Three segments comprise the AEA that contribute to the overall design of the Army and support the ability to operate in a joint and coalition environment: OF, GF, and Network. The Army manages AEA using a tiered approach and its architectures will be developed in accordance with a rules-based framework approved by the CIO / G-6 and aligned with DOD IT standards. The AEA is composed of—

(a) Unit, segment, or domain architecture guidance. Segment and organizational architectures are components of the AEA. It includes reference models and federated architecture concepts that describe the relationship between architectures at different levels (e.g., unit, segment, and domain architectures) by using fit-for-purpose architecture models as required. Domain architecture is developed or sponsored by the domain data stewards.

(b) Mission areas describe the IT portfolio of services and material investments in support of various Army operations: IT enabling the OF is compiled in the WMA; IT enabling the GF and the 15 end-to-end business processes are in the BMA; and IT enabling and supporting the institutional Army, installations, and enabling the provision of enterprise services is in the EIEMA.

(c) Processes that frame IT investments and support analysis. IT / network requirements in the WMA and BMA are supported by the enterprise services provided by the EIEMA.

(d) Rules and guidance for AEA relationships with external architectures. The AEA must conform to DOD Information Enterprise Architecture (IEA) and federal architecture policies and directives. When interfacing with other DOD external components' architectures, the vertical and horizontal alignments must be depicted.

(2) AEA Executive Architects. The executive architects are responsible for the OF, GF, and network segments that together constitute the Army enterprise. They verify, validate, certify, approve and assess architectures within their area of responsibility. The current executive architects for the AEA are—

- (a) The Under Secretary of the Army (Business Transformation) (DUSA (BT) for the GF.
- (b) The ASA (ALT) for MC solution architectures.
- (c) The CIO / G-6 for IT, network, and technical architecture, and network / technical standards.
- (d) The Deputy Chief of Staff, G-3/5/7, for OF structure architecture.

(e) The Commander, U.S. Training and Doctrine Command (TRADOC) for Warfighting operational architecture.

(3) Architecture Views and Approved Frameworks. The diverse nature of the architecture describing the GF, OF and network architecture of the Army, and the need to support Joint, Office of the Secretary of Defense (OSD), and federal government architecture requirements and best practices, require that architecture products are developed under a variety of frameworks—

(a) These frameworks may be expressed in rule sets, reference architectures, ontology's, common operating environments, or standards.

(b) If however, a specific architecture artifact is mandated in support of a major DOD or Joint process, such as JCIDS or PPBE, the AEA will have the authoritative data and tools available to develop the required products.

(c) Views, artifacts and other products will be dictated by the questions to be answered by the architecture, decisions to be made, process reporting requirements, the architecture tools being used and most importantly the data underpinning the architecture.

### **15-13. Army Data Management - LandWarNet 2020 and the Joint Information Environment**

Data is a strategic asset. The Army CIO is responsible for and prescribes the Army's IM policy at the strategic level. Consistent with this responsibility, the Army CIO establishes and oversees data transformation through the Army Data Management Program (ADMP). The Army CIO appoints the Army's Chief Data Officer (CDO). The CDO is responsible for developing, implementing, and enforcing Army and federal data standards and strategy for the Army. Each Mission Area / Functional Area Proponent will identify a Data Steward who is empowered by the Army CIO to perform the same CDO responsibilities within their functional areas. As a team, they will lead the data transformation that is fundamental to Net-Centricity.

a. The Army Data Strategy, aligned to the DOD Data Strategy, guides the Army towards ensuring data and information is visible, accessible, understandable, trusted (to include protection, assurance, and security), and interoperable throughout the data life-cycle to any authorized DOD consumer or mission partner to the maximum extent allowed by law and DOD policy. The Army Data Strategy will provide guidance to data producers to maximize information availability to authorized consumers. This will allow commanders and their organizations to have broad and efficient access to data-reducing duplication of efforts by leaders / Soldiers and their joint / multinational partners. It will also increase interoperability among systems and reduce development costs. The Army Data Strategy consists of the following components—

(1) Army Information Architecture (AIA). The AIA provides the foundation to accelerate Army transformation to net-centric information sharing in two ways. The first is design and development guidance for enabling information sharing. The second is a set of compliance requirements for assessing the level to which systems meet net-centric information sharing objectives.

(2) Authoritative Data Sources (ADS). This allows commanders, decision makers, and stakeholders to target recognized systems for obtaining specific trusted information such as social security numbers and unit readiness, without having to choose from several systems for the correct data.

(3) Information Exchange Specifications (IES). Enables efficient exchange of information between systems and saves resources, with agreed upon definitions and formats, for reuse by a larger group of systems. In other words, it will be easier for systems to exchange data because they speak the same language.

(4) Governance. In large enterprises such as the Army, data is produced by many different organizations, directed toward their specific needs and requirements. However, when data needs to be shared across the enterprise, as is certainly the case for the Army, there are considerations beyond the specific needs of the organization. These include issues of trust, security, policy, understandability, quality, and so on. Data governance is the means to address these issues. In compliance with Army Directive 2009-03, Army Data Management, the CDO has developed a governance approach that provides a collaborative environment with active participation from across the Army. The CDO recognizes that the individual proponents, as identified by the Assistants SECARMY, ACOMs, and Deputy Chiefs of Staff, are responsible for the operational success of their areas and are ideally suited to identify how data can best be exploited to support them in achieving mission success.

b. Army Data Management Program (ADMP). The ADMP establishes required policies and procedures for the production of data standards to ensure enterprise-wide machine process ability of Army

## HOW THE ARMY RUNS

information resources and interoperability for all pertinent data exchanges among Army ISs. The ADMP addresses the creation and implementation of data standards applicable to automated systems, software applications, data exchanges, databases, record and document management, and information presentation within and across warfighting and business systems. Army Data Board structure, positions, responsibilities, and other information is also referenced in AR 25-1. The ADMP facilitates the dissemination and exchange of information among organizations and ISs throughout the Army, DOD, and the federal government. The ADMP implements the information standards portion of the DISR and supplements the DOD Net-Centric Data Strategy. Net-centricity is dependent upon the ability to locate and retrieve information and services regardless of where they are stored. A common data management strategy is essential to allowing authorized users to access required information (see DODD 8260.1 for information sharing restrictions).

### **15-14. Cybersecurity**

Cyber attacks threaten the Army network and its information every day, putting operations and personnel at risk. Commanders require operational freedom to maneuver in cyberspace with the ability to identify vulnerabilities while minimizing risk. Network security and cybersecurity are therefore paramount for protecting and safeguarding our information and communications systems ensuring the integrity of operational Warfighting networks and business information systems critical to Army mission success.

a. The Army CIO / G-6 is responsible for overseeing and managing the Army Cybersecurity program. The Army Information Assurance program protects information and its critical elements, including the systems and hardware that use, store, and transmit that information by identifying, measuring, and mitigating risk. Cybersecurity incorporates functions from Operations Security (OPSEC), Communications Security (COMSEC), Transmission Security (TRANSEC), Information Security (INFOSEC), personnel security, and physical security to protect and safeguard our IT and communication technologies as well as our warfighting and business solutions.

b. Cybersecurity is everyone's responsibility. Leaders must incorporate cybersecurity into their risk management programs, make certain their personnel are accountable for their daily practices that put our information and communication technologies at risk, and link cybersecurity to readiness. All personnel must be aware of the potential risks they present and take proper precautions to protect the information entrusted to them.

## **Section IV**

### **Army Chief Information Officer / G-6 Strategic Partnerships**

#### **15-15. Army Partnerships**

Given the cross-cutting missions of CIO / G-6 to provide an integrated, secure, standards-based information environment that address the mission needs of the Army, internal and external partnerships are critical. Partnerships are required to accurately define, develop, execute, and share critical information securely to meet the changing needs of the Army, DOD, other federal agencies and mission partners.

a. Principal HQDA officials. Within their respective areas, principal HQDA officials serve as the proponent for information requirements and associated doctrine, organization, training, materiel, leadership and education, personnel and facilities policy (DOTMLPF-P) solutions within their assigned functional areas of responsibility. As the proponent, the principal official manages functional processes within their respective portfolio areas to maximize the efficiency of enterprise processes and improve effectiveness of information systems. The principal official requests and defends the resources needed to support the development, deployment, operation, security, logistics support, and modification of IT investments through the PPBE process.

b. ASA (ALT). Army CIO / G-6 and ASA (ALT) are strategic partners in delivering standardized, compatible, interoperable, secure, and resourced solutions to the Warfighter. Working with CIO / G-6, ASA (ALT) serves as the source selection authority for acquiring IT solutions. In addition, ASA (ALT) oversees project managers and program executive offices (PEO) to ensure that IT and National Security System (NSS) systems successfully meet Army IT requirements. CIO / G-6 works closely with the PEOs on IT related programs, including—

(1) PEO Enterprise Information Systems (EIS). PEO EIS provides joint and Army organizations with information dominance by developing, acquiring, integrating, deploying, and sustaining net-centric knowledge-based IT and business management systems, communications, and infrastructure solutions through leveraged commercial and enterprise services. The PEO EIS oversees the management of Computer Hardware, Enterprise Software Solutions (CHESS) and Army Knowledge Online (AKO).

(a) The CHESS office provides a full range of IT, IT infrastructure, and information systems (hardware, software, peripherals, networking, and infrastructure support services) to Army, DOD, foreign military, Soldiers, and federal agencies consistent with DOD and HQDA policy.

(b) AKO is the Army's current enterprise portal for accessing information (see para 15-8); however, as the Army transitions to enterprise services, like enterprise email, the approved enterprise solutions and tools will change.

(2) PEO Command Control Communications-Tactical (C3T). PEO C3T provides the computer systems, radios and communications networks required to fight and win the Nation's wars. PEO C3T oversees the management of the MilTech Solutions and the Warfighter Information Network-Tactical (WIN-T).

(a) MilTech Solutions provide web-based tools and technologies that improve workforce collaboration and enable faster, more effective support to the Warfighter. MilSuite, provides a behind-the-firewall version of familiar social media sites.

(b) Program Manager (PM) WIN-T provides the communications network (satellite and terrestrial) and services that allow the Soldier to send and receive information to execute the mission. WIN-T incrementally develops and delivers products that simplify network initialization and management and significantly increase capabilities.

c. DCS, G-2. DCS, G-2, as the functional lead for the Army intelligence community, works with CIO / G-6 to ensure that IT investments in that community align with Army IT investment strategies.

d. DCS, G-3/5/7. CIO / G-6 and DCS, G-3/5/7 are strategic partners in delivering Warfighter-required capabilities. DCS, G-3/5/7 validates, synchronizes, and prioritizes Army network requirements to meet current, emerging, and future needs of operational commanders. DCS, G-3/5/7 ensures that all network-related requirements fit within the Army's enterprise network as part of the LandWarNet capabilities set.

e. DCS, G-8. CIO / G-6 and DCS, G-8 work closely to develop and defend Army IT programs. CIO / G-6 collaborates with DCS, G-8 in the development of C4, intelligence, surveillance, and reconnaissance (C4ISR) positions presented to relevant governance boards. In addition, Army Portfolio Management Solution (APMS) (a CIO / G-6 system) is housed in the G-8 data warehouse to enable closer alignment with GFEBs.

f. U.S. Army Cyber Command (ARCYBER). Is an Army service component command to U.S. Strategic Command (USSTRATCOM) supporting U.S. Cyber Command, for information dominance of cyberspace operations. The command is intended to be the Army's single point of contact for external organizations regarding cyberspace and Information Operations. As the single C2 authority for all collateral top secret and below Army network operations, ARCYBER works closely with CIO / G-6 to establish the vision, direction, and architecture of I3MP.

g. U.S. Army Network Enterprise Technology Command (NETCOM). As directed by the U.S. Army Cyber Command (ARCYBER), NETCOM serves as the Designated Approving Authority for the Army enterprise. NETCOM is the Army IT integrator advising the end-to-end management of the Army's enterprise service area to ensure the CIO / G-6 achieves a single, virtual enterprise network.

h. Assistant Secretary of the Army (Manpower & Reserve Affairs) (ASA (M&RA)). Army CIO / G-6 and ASA (M&RA) are strategic partners within the Army Civilian Career Program Proponency system, providing structured plans, processes, and activities that support the systematic organizational, occupational, and individual growth of the Army IT / Cyber workforce throughout the civilian human capital lifecycle.

## **15-16. External Partnerships**

a. Federal CIO Council. The CIO / G-6 serves as a member of the Federal CIO Council. The Federal CIO Council, in partnership with all federal agencies, serves as a forum for CIOs to improve practices in the design, use, sharing and performance of federal information resources and cross-agency challenges.

b. DOD CIO. The DOD CIO is the principal staff assistant and advisor to the Secretary of Defense (SECDEF) on information resources management. The DOD CIO sets the vision and strategic goals, and provides direction to DOD in executing policies and practices to deliver agile and secure information capabilities to enhance decision-making and combat mission needs. The DOD CIO and the Army CIO /

## HOW THE ARMY RUNS

G-6 are partners in addressing DOD-wide IM, IT business, and Warfighting information capabilities essential for enterprise-wide solutions and operational effectiveness. CIO / G-6 is a member of the DOD CIO EB and Military Department CIO Executive forums to advise the DOD CIO on strategic direction, requirements, and implementation strategies to meet Army's critical information mission needs.

c. Other DOD Partnerships. The Army CIO / G-6 also has an information capability delivery partnership with other DOD components such as the Defense Information Systems Agency (DISA), the Joint Staff (JS) and the other military department CIOs to address cross-cutting information and service delivery requirements to enable communication, collaboration and sustaining of secure trusted environments. This includes how information will be made available and how to develop and deliver enterprise service solutions.

d. Industry. Industry partners play an important role in supporting the mission of the CIO / G-6. These businesses offer technology and strategy consulting that provide IT solutions for current and future forces. In addition, CIO / G-6 works with industry partners to develop and implement enterprise licenses that use the Army's buying power to realize cost savings and efficiencies.

### 15-17. Cultural Changes

a. In the current economic climate, the Army expects continued budget uncertainty while potential threats to national security continue to evolve. At the same time, the Army is becoming primarily CONUS-based, while the threat environment demands the ability to deploy globally with little-to-no notice. To fulfill the U.S.' national security objectives, the Army must be agile and prepared to fight upon arrival. Further, the Army must create a smaller footprint in theater while providing every type of required support to the Soldier at the tactical edge, and it must be capable of operating with all mission partners. While the Army transitions to an expeditionary Army that is smaller and yet more capable, the network is the core of that smaller, capable Army.

b. The Army is supporting network modernization efforts through participation in the development and maturation of the DOD JIE. JIE is DOD's construct to provide a single, secure, reliable, timely, effective, and agile C4 enterprise information environment for use by joint forces and non-DOD mission partners across the full spectrum of operations, at all echelons, and in all operational environments. The CIO / G-6 has aligned its top IT initiatives to support the JIE effort, without being dependent on it.

c. Other key modernization efforts include—

(1) Modernizing the network as a platform by improving governance, enforcing compliance, implementing agile IT acquisition, and ensuring transparent IT spending.

(2) Standardizing a basic architecture called the common operating environment (COE)—a centrally approved, commercially-based set of computing technologies and standards to which the network itself and all applications and systems riding the network must adhere.

(3) Updating and consolidating network infrastructure.

(4) Consolidating and securing networks.

(5) Moving to a capability set management construct to foster end-to-end network modernization.

(6) Building a comprehensive IT / Cyber workforce development strategy and implementation plan to maximize Soldier and civilian personnel management.

## Section V

### Summary, Key Terms, and References

#### 15-18. Summary

a. Army transformation will enhance the Service's ability to conduct operations. The goal of the CIO / G-6 is to provide the strategy to enable better and faster decisions than U.S. adversaries.

b. IT / IM strategy provides for the integration and the interoperability of processing, storing, and transporting information over a seamless network, allowing access to universal and secure Army knowledge across the enterprise. As the Army moves toward building a single, secure, standards-based network that ensures access at the point of need and enables global collaboration, current operational systems are examined for the results they achieve and benefits they provide to the Army. If the systems do not contribute to a world-class net-centric knowledge system, they face elimination or migration to systems that do.

c. The CIO / G-6 commits to meeting the challenges that come with transforming the Army into a force that is strategically responsive and dominant. To that end, the CIO / G-6 is investing in today's technology to stimulate the development of doctrine, organizational design, and leader training to improve the future force. Doing so will extend the Army's technological overmatch.

## 15-19. Key Terms

a. *Information Management.* The planning, budgeting, manipulating, and controlling of information throughout its life cycle.

b. *Information Technology.* Any equipment or interconnected system or subsystem that is used in the automatic acquisition, storage, manipulation, management, movement, control, display, switching, interchange, transmission, or reception of data or information by an executive agency (EA). For purposes of the preceding sentence, equipment is used by an EA if the equipment is used by the EA directly or is used by a contractor under a contract with the EA which: one, requires the use of such equipment; or two, requires the use, to a significant extent, of such equipment in the performance of a service or the furnishing of a product. The term "information technology" includes computers, ancillary equipment, software, firmware, and similar procedures, services (including support services), and related resources. The term "information technology" does not include any equipment that is acquired by a federal contractor incidental to a federal contract. The term "information technology" does not include national security systems as defined in the CCA of 1996 (40 U.S.C. 1452).

c. *Communications.* JP 6.0 describes a joint communications system as one that is comprised of the networks and services that enable joint and multinational capabilities. The objective of the joint communications system is to assist the JFC in C2 of military operations. Effective C2 is vital for proper integration and employment of capabilities. The HQDA's end-to-end communications system supporting the JFC is called the LandWarNet. The DODIN conceptually unifies DOD's information systems and networks into a real-time information system of systems that provides increased information capabilities to the joint force. Communications systems are more than electronic boxes, wires, and radio signals, and the DODIN is more than a collection of information networks. The interdependence of the parts, as well as the processes, policy, and data on those systems, permeate daily life, and preparation for and execution of operations. An effective communications system helps commanders maintain the unity of effort to apply their forces' capabilities at critical times and places to achieve objectives.

d. *Information Resource Management.* IRM is the process of managing information resources to accomplish agency missions. The term encompasses both information itself and the related resources, such as personnel, equipment, funds, and information technology.

e. *Capital Planning and Investment Control.* The management process for ongoing identification, selection, control, and evaluation of investments in information resources. The process links budget formulation and execution, and is focused on agency missions and achieving specific program outcomes.

f. *LandWarNet.* LandWarNet is the portion of the DODIN operated by the Army. LandWarNet is the set of information solutions, and associated processes that collect, process, store, disseminate, and manage information on demand to warfighters, policy makers, and support personnel, whether interconnected or stand-alone, including owned and leased communications and computing systems and services, software (including applications), data, security services, other associated services, and national security systems.

g. *Cyberspace operations.* CO includes offensive cyberspace operations (OCO), defensive cyberspace operations (DCO), and DODIN operations.

## 15-20. References

a. Army Regulation 10-87, Army Commands, Army Service Component Commands, and Direct Reporting Units.

b. Army Regulation 25-1, Information Technology.

c. Army Regulation 25-2, Information Assurance.

d. Army Regulation 70-1, Army Acquisition Policy.

e. CIO / G6 Enabling Success @ <http://ciog6.army.mil/>.

f. Department of the Army Pamphlet 25-1-1, Information Technology Support and Services.

g. General Order 2017-01, Assignment of Functions and Responsibilities Within the HQDA.

h. General Order 2002-05, Establishment of the U.S. Army Network Enterprise Technology Command / 9th Army Signal Command; Transfer and Re-designation of the Headquarters and Headquarters

## HOW THE ARMY RUNS

Company, 9th Army Signal Command; Discontinuance of the Communications Electronics Services Office and the Information Management Support Agency.

i. Joint Publication 6-0, Joint Communications System.  
j. Office of the Chairman of the Joint Chiefs of Staff. Joint Information Environment White Paper. Washington D.C.: Joint Chiefs of Staff, 2013.

k. SECARMY, "Information Technology Management Reform (ITMR) Implementation Plan," Washington, D.C.: Office of the SECARMY, 2013.



## Chapter 16

### Installation Management Community

#### Section I Introduction

##### 16-1. Chapter Content

This chapter provides the history, hierarchy, roles and missions, programs, and initiatives of organizations in the Installation Management Community (IMC). Installations remain a big business. As of 2016, the Assistant Chief of Staff for Installation Management (ACSIM) and Headquarters, Department of the Army (HQDA) manage Defense and Army budget and resources in excess of \$15.1 billion. Installations cover over 13.5 million acres of land, more than the combined acreage of the States of Maryland, Connecticut and Rhode Island. Installations maintain well over 139,000 buildings covering more than 982 million square feet. Army facilities represent a replacement value of more than \$437 billion. Installations are home to the Force and home to the Army Family - where the Army lives, works, trains, deploys, sustains and prepares to meet tomorrow's challenges. Army posts and surrounding communities are home to well over one million Service members and their Families. Installations house approximately one-third of Army Families and can house nearly 200,000 permanent party single Soldiers. Army installations are where a quarter of a million Civilian employees and nearly 150,000 contract employees come to work every day.

##### 16-2. History

a. In the 1980s and early 1990s, findings from a host of inspections, studies, and surveys determined that installations should and could be managed far more effectively and efficiently. As a result, the Army leadership took the following actions to integrate widely diverse, and often competing, installation management functions to better prepare commanders for the increasingly complex and important work of running Army and Department of Defense (DOD) installations:

- (1) Established ACSIM in 1993.
- (2) Established centrally selected garrison commanders (GCs) in 1993.
- (3) Published Field Manual 100-22 Installation Management in 1994.

b. In an effort to standardize its garrisons, on 1 October 2002, the Installation Management Agency (IMA) was established to support Transformation of Installation Management (TIM). Using an enterprise approach, IMA removed the burden of base support from 15 major commands. This brought uniformity to facilities and services of 184 installations, worldwide - and by 2006, this was accomplished with \$4.5 billion less than in 2003.

c. After proven success, the Army transformed the agency into the U.S. Army Installation Management Command (IMCOM). In October 2006, the U.S. Army Environmental Command (USAEC) joined IMCOM as a subordinate command. Today, as it has for more than 40 years, USAEC provides the knowledge, tools and programs supporting ready and resilient Soldiers, installations, and commands by balancing military training with sound environmental practices. Also in October 2006, the Family and Morale, Welfare and Recreation Command (FMWRC) was established with the stand-up of IMCOM. In June 2011, FMWRC became the G-9 directorate of IMCOM. This integration ensured commitment to the Community Covenant, a program that is designed to foster and sustain effective state and community partnerships with the Army to improve quality of life for Soldiers and their families, both at their current duty stations and as they transfer to other states. It is a formal commitment of support by state and local communities to Soldiers and Families of the Army, Active, Guard and Reserve. While Community Covenant is an Army program, it extends to other Military Services as well, recognizing that many community efforts support all Service Members and their Families regardless of the uniform they wear.

This makes Army garrisons the platforms of readiness and resilience for Soldiers, Families, and Civilians they are today, complete with programs and services enhancing the mind, body, and spirit of those who always answer our nation's call. Just months later, Base Realignment and Closure Act of 2005 brought all the elements; relocating from Aberdeen Proving Ground, Maryland, and Crystal City and Alexandria, Virginia; to a single campus at Joint Base San Antonio, Texas. In October 2012, IMCOM transferred its Directorates of Logistic (DOL) to U.S. Army Materiel Command (AMC).

d. In October 2015, IMCOM became a separate three-star Direct Reporting Unit to the Chief of Staff Army and the commander was no longer dual-hatted as the ACSIM. USAEC remains a major subordinate command of IMCOM. On 1 November 2016, IMCOM realigned from geographical regions and established five functionally-aligned directorates, IMCOM-Readiness, co-located with U.S. Army Forces Command; IMCOM-Training, co-located with U.S. Training and Doctrine Command; IMCOM-Sustainment, co-located with AMC; IMCOM-Europe; and, IMCOM-Pacific. The directorates are organized to be more efficient and improve mission command through unity of purpose, a smaller number of garrisons to manage, and similar demographics of communities. The directorates solve functional challenges for GCs, coordinate Headquarters, IMCOM (HQ IMCOM) support, and drive/assess garrison execution of service delivery.

e. The Army's installations have been significantly reshaped by five rounds of BRAC authorized by Congress: 1988, 1991, 1993, 1995, and 2005.

(1) The Army is currently saving approximately \$1.04 billion per year from closures and realignments of the 2005 BRAC round, and approximately \$943M per year from the four prior BRAC rounds.

(2) Each BRAC round affords the Army opportunity to comprehensively review its real estate portfolio, reassess how it calculates military value, examine where its missions are currently located, and optimize missions to ensure they are being performed in the right locations. The result of five BRAC rounds is nearly \$2 billion in annual reoccurring savings and a better alignment of force structure, military value, and infrastructure.

(3) 2005 BRAC Recommendation #146 directed realignment of 26 Army, Navy, Air Force, and Marine Corps installations into 12 joint bases by 15 September 2011. A lead Military Service, referred to as "Supporting Component", is responsible for management and provision of installation support services for two or more installations that comprise a joint base. Other Military Services at the joint base are referred to as "Supported Component(s)." All installation support functions (unless explicitly excluded) transferred from the Supported Component to the Supporting Component to include the Supported Component's associated real property and installation support funding, personnel, and equipment. The primary joint basing policy document is the Joint Base Implementation Guidance (JBIG). The 12 joint bases and designated lead agency are as follows:

- (a) Joint Base Anacostia-Bolling, Washington, DC, Navy.
- (b) Joint Base Andrews-Naval Air Facility, Washington, Maryland, Air Force.
- (c) Joint Base Charleston, South Carolina, Air Force.
- (d) Joint Base Elmendorf-Richardson, Alaska, Air Force.
- (e) Joint Base Langley-Eustis, Virginia, Air Force.
- (f) Joint Base Lewis-McChord, Washington, Army.
- (g) Joint Base McGuire-Dix-Lakehurst, New Jersey, Air Force.
- (h) Joint Base Myer-Henderson Hall, Washington, DC, Army.
- (i) Joint Base Pearl Harbor-Hickam, Hawaii, Navy.
- (j) Joint Base San Antonio, Texas, Air Force.
- (k) Joint Expeditionary Base Little Creek-Fort Story, Virginia, Navy.
- (l) Joint Region Marianas, Guam, Navy.

### 16-3. IMC Hierarchy

The Army develops and implements strategies, policies, programs, and resources through an effective network of installations and support capabilities referred to as the IMC. The key levels of efforts by commands and staffs within the IMC are shown in Figure 16-1.

# Installation Management Community Hierarchy

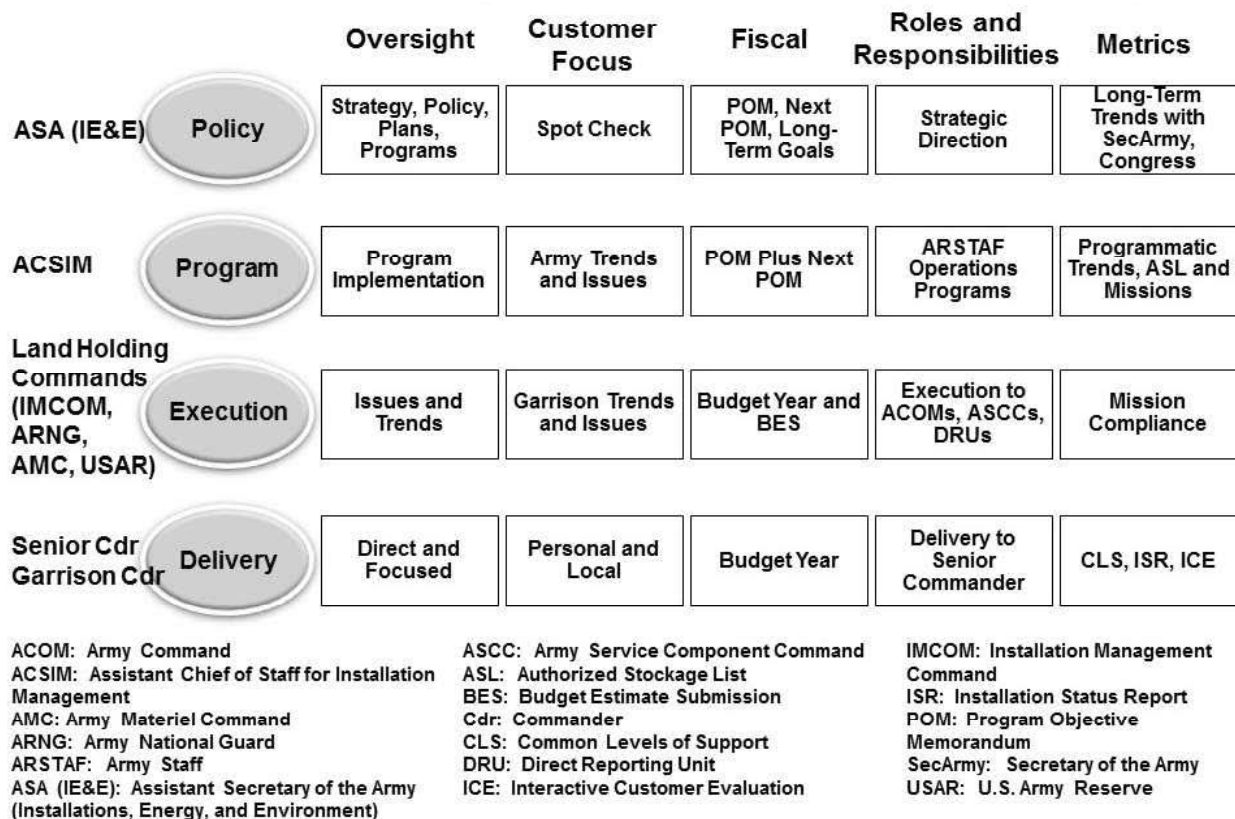

Figure 16-1. Installation Management Community Hierarchy

## Section II Roles and Missions

### 16-4. Assistant Secretary of the Army (Installations, Energy and Environment) (ASA (IE&E))

a. The ASA (IE&E) is the principal adviser to the Secretary of the Army on matters related to Army installations, energy security, and the Army's compliance with environment, safety, and occupational health standards. ASA (IE&E) sets the strategic direction and ensures Army efforts are executed consistent with law, regulations, and policy. The ASA (IE&E) has responsibility for:

(1) Establishing strategic direction for the Planning Programming and Budget Execution (PPBE) process within the ASA (IE&E)'s areas of responsibility, including facilities investment, military construction, installations, Army real estate, energy and water security, operational energy, sustainability, the environment, safety and occupational health, and associated resource allocation decisions and policies. Coordinating and integrating direction with the Assistant Secretary of the Army (Financial Management and Comptroller) (ASA (FM&C)); Chief Information Officer (CIO); Deputy Chief of Staff (DCS), G-3/5/7; DCS, G-4; DCS, G-8; ACSIM; and other Department of the Army (DA) officials and organizations. The ASA (IE&E) serves as Co-Chair with the ACSIM for the Installations Program Evaluation Group (II PEG).

(2) Implementing strategic guidance and providing supervision for policies, plans, and programs for facilities investments, military construction, energy and water security, operational energy, overseas bases, and environmental initiatives executed by the Army Staff (ARSTAF), including the ACSIM; DCS,

G-4; other DA officials, organizations and commands, including the U.S. Army Corps of Engineers (USACE).

(3) Supervising and facilitating the development and management of Army installations, including facilities investments to support readiness, design, construction, physical security and critical infrastructure protection of installations to ensure continuity of operations, energy and water security, environmental, safety and occupational health; and advising the SecArmy and the CSA on installations' suitability for stationing.

(4) Supervising development and implementation of policies and programs for Army real property, including acquisition, management, disposal, exchanges, public domain withdrawals, condemnation, and donations. Setting policy for and supervising the management of historic properties owned or leased by the Army and the Army homeowners' assistance program.

(5) Developing policies for and ensuring the implementation of policies for BRAC, stationing, planning and utilization, reuse and economic adjustment programs.

(6) Supervising Army privatization initiatives and their implementation.

(7) Supervising and developing policies and budget requests for Army military construction, including overseas military construction agreements, and ensuring consistency with statute, regulation, and Army and DOD policy.

(8) Supervising Army energy and water security and sustainability, including development of strategy and policy, coordination of initiatives, supervision of HQDA councils and committees and representation of Army environmental and sustainability interests in coordination with Federal regulatory agencies and State and local governments.

(9) Supervising and developing policies and programs for Army environmental efforts, including environmental compliance; pollution prevention; environmental impact analysis; stewardship of natural, cultural and historic resources; and environmental cleanup and restoration, including Formerly Used Defense Sites (FUDS).

(10) Coordinating with the Assistant Secretary of the Army (Acquisition, Logistics, and Technology) (ASA(ALT)) to ensure that environmental, safety, health, energy and water security, operational energy efficiency, green procurement, and installation management issues are appropriately addressed by materiel developers; integrated into acquisition program planning and documentation; and addressed as risk areas during milestone decision reviews.

(11) Providing policy and supervising Army-wide safety, occupational and environmental health risk management, including sanitation and hygiene.

(12) Supervising development of Army policy for environmental, safety and occupational health aspects of DOD's Chemical Demilitarization Program and, in coordination with the ASA (ALT) and DCS, G-3/5/7, serving as the Army's Chemical, Biological, Nuclear, and Conventional Treaty Verification and Compliance Official.

b. Principal Deputy Assistant Secretary of the Army (PDASA). The PDASA (IE&E) is the senior Deputy Assistant Secretary of the Army (DASA) reporting directly to the ASA (IE&E) and is responsible for integrating ASA (IE&E) activities within the Army secretariat and HQDA staff. The PDASA is designated as the Project Executive Officer (PEO) of the National Museum of the U.S. Army (NMUSA).

c. The ASA (IE&E) has four DASAs.

(1) DASA (Energy & Sustainability) (DASA (E&S)) is the Senior Energy Executive for the Army. This office provides strategic leadership, policy guidance, program oversight, and outreach for energy and sustainability throughout the Army enterprise to enhance current installation and operational capabilities, safeguard resources, and preserve future options. DASA (E&S) also oversees climate change adaptation for installations, the Army's net zero policy as executed by commands, third-party financing for energy and water projects, and the Office of Energy Initiatives.

(2) DASA (Environment, Safety and Occupational Health (ESOH)) provides policy, programming and oversight of the Army's ESOH programs; oversees all Army environmental programs; provides technical assistance on explosives, munitions and chemical warfare materiel response; provides recommendations to milestone decision authorities on Army materiel regarding ESOH concerns; executes the Army's arms control program; and serves as the Executive Agent for several DOD programs. In addition, DASA (ESOH) is the proponent for Army safety and occupational health policy and programs.

(3) DASA (Installations, Housing and Partnerships (IHP)) provides worldwide policy, programming and oversight of the SecArmy's Title 10 US Code responsibilities in the areas of real estate, military

construction, engineering, housing and BRAC. Represents the Army's business interests in privatization/partnership projects (i.e., Residential Communities Initiative (RCI), Privatization of Army Lodging (PAL), and Intergovernmental Support Agreements (IGSA)). In addition, provides oversight reviews, approvals, congressional testimony and notifications as required by statutes in the responsible areas. Coordinates Infrastructure Analysis and Evaluation of real property as well as stationing.

(4) DASA (Strategic Integration (SI)) is the lead official for integration and coordination of installation initiatives into Army-wide policies and plans. In this capacity, DASA (SI) serves as the ASA (IE&E) representative in development of Army strategic plans and guidance including the Army Campaign Plan (ACP). The office develops strategy, executes business transformation at the secretariat level and conducts day-to-day operations for the ASA (IE&E) in the II PEG.

### **16-5. Assistant Chief of Staff for Installation Management**

a. The ACSIM is the principal military adviser to the ASA (IE&E) on a broad array of programs, including management of facilities and infrastructure, environmental programs, housing, installation logistics, public and private partnerships, and energy and water security and sustainability. The ACSIM is the principal ARSTAF adviser to the CSA on installation and Family support matters and assists the CSA in acting as the agent of the SecArmy in carrying into effect approved plans and recommendations. The ACSIM is also the principal military adviser to the Assistant Secretary of the Army (Manpower and Reserve Affairs (ASA (M&RA))) and ASA (FM&C) for Family and Morale, Welfare and Recreation, Nonappropriated Fund Instrumentalities (NAFIs), and Soldier and Family readiness programs. Under supervision of the ASA (IE&E), ASA (FM&C), and ASA (M&RA) the ACSIM plans, develops, implements, resources, oversees, and evaluates the execution of strategies, policies, plans, and programs for the delivery of installation services and infrastructure to support readiness. The ACSIM serves as the Co-Chair with the ASA (IE&E) for the II PEG. The ACSIM has responsibility for:

(1) Supervising and coordinating the development, implementation and evaluation of policies, plans and strategies for military facilities investment requirements, housing, privatization, installation, environmental, water management and energy security and sustainability programs.

(2) Supervising and coordinating the development, validation and execution programs for resourcing of environmental programs, housing, privatization, water management and energy security and sustainability programs on assigned Army installations.

(3) Developing standards to evaluate installation and base operations, including compliance with environmental requirements and energy efficiency.

(4) Serving as the proponent for installation management doctrine.

(5) Serving as the ARSTAF proponent and execution authority for Army wide installation-related environmental programs and for installation environmental programs assigned to the Army by DOD.

(6) Ensuring execution of approved operational programs for the reorganization, realignment and closure of installations under supervision of the ASA (IE&E).

(7) Developing infrastructure and monitoring the execution of programs for installation services and management that support readiness and enhance the well-being of Soldiers and Families.

(8) Assisting and supporting the ASA (M&RA) in planning, development, budgeting, implementation and evaluation of installation morale, welfare and recreation programs and non-appropriated fund instrumentalities.

b. The ACSIM is supported by four directorates; Installation Services, Information Technology, Operations, and Resources:

(1) Installation Services Directorate interprets strategic guidance, provides policy and creates priorities for resources in order to create a supportive and sustainable environment through world class housing, environmental stewardship, responsive logistics, collaborative partnerships and enhanced quality of life programs for Soldiers, Civilians and their Families. The directorate is made up of four divisions. The Housing Division focuses on providing quality Soldier and Family housing facilities, programs and services, including community housing advocacy, the First Sergeant's Barracks Program (FSBP) 2020, General/Flag Officer quarters, housing furnishings, and developing barracks buyouts/upgrades and modernization programs. The Career Program 27 Proponency Office, led by a senior Housing Specialist directly reporting to the Director of Installation Services, Office of the Assistant Chief of Staff for Installation Management (OACSIM), is the proponent for all career matters affecting all members of the Army's Housing Management Team. The goal of the proponency office is to provide support to all

members regarding education, training, professional development and future advancement. Privatized Housing and Lodging Branch is the ACSIM center of excellence for privatization and Partnerships ensuring maximization and sustainability of Army assets and services through partnerships with private sectors. Key programs are the Residential Communities Initiative, Privatization of Army Lodging, and Privatized Enlisted & Officer Unaccompanied Housing Initiative. The Logistics and Services Division works to reduce greenhouse gas emissions; optimize the Non-Tactical Vehicle (NTV) fleet; develop policy and programming for Municipal Services, Laundry, Dry Cleaning, and Civilian Inmate Labor; provide policy and processes that provide for flexible Fire & Emergency Services in an all-hazards environment; and develop standardized firefighter qualifications, duty descriptions, and training requirements. Soldier and Family Readiness Division provides policies, resources, and strategies that promote Soldier and Family readiness, adaptability, and self-reliance, to include Army Community Service; Child, Youth and School Services; Community Recreation and Business programs; NAFIs; and senior leader initiatives such as Total Army Strong. The Environmental Division manages Army environmental programs in support of the Operating and Generating Forces, plans and programs resources; establishes program execution priorities and approves work plans; develops regulations and program guidance for the Army.

(2) Information and Technology Directorate sets the strategic direction and provides effective information technology (IT) and information management (IM) capabilities that enable the OACSIM business areas to support Soldiers, civilians and their families. The directorate is comprised of two divisions: Governance, Strategy and Cyber Division, and the Enterprise Integration Division. The Governance, Strategy and Cyber Division provides an objective and standardized governance structure with supporting processes to ensure IT investments are visible, selected, monitored and compliant with laws and regulations. The division also provides Information Assurance Program Manager (IAPM), Operational Security (OPSEC), Risk Management Framework (RMF) support to ensure appropriate levels of confidentiality, integrity, authentication, non-repudiation, and availability of installation management data, information and knowledge. This division also provides integrated information technology support for desktop, network and enterprise managed IT requirements and services in coordination with the HQDA IT service provider. The division operates and maintains the OACSIM Knowledge Portal used for knowledge sharing and collaboration. The Enterprise Integration Division manages the IE&E Domain within Headquarters Army Business Mission Area. The division supports Army and Installation Management business transformation strategy and priorities by leading the Army Installation Business Enterprise Architecture (BEA), Capital Planning and Investment Management (CPIM) and Portfolio Management (PfM) Programs. The division provides critical portfolio and certification support to IE&E Domain stakeholders through the Defense Business Systems (DBS) Management Council (DBSMC) investment management process to ensure IE&E DBS investments in the IE&E portfolio support business needs while minimizing risks and achieving DOD and federal strategies for business systems. This division is also the process champion for Acquire to Retire (A2R) Real Property, Service Request to Resolution (SR2R) and Environmental Liability (EL) End to End (E2E) business processes.

(3) Operations Directorate oversees development and coordination of program requirements, strategy, policies, and reporting pertaining to facilities, energy, military construction, and real property that support Army objectives and improves quality of life for Soldiers, Civilians, and Families. The Directorate has five divisions: BRAC, Construction, Energy and Facilities Policy, Real Property Asset Management, Strategic Plans Operations, and Strategic Plans. The BRAC Division continues to be ready for potential future BRAC rounds and executes cleanup and transfer of BRAC and assigned non-BRAC excess Army property. The Construction Division plans, programs, and executes the Army military construction (MILCON) program and provides interface for the nonappropriated fund construction program. The Construction Division provides oversight and participates in regular updates from USACE on execution of the Army construction program. The Energy and Facilities Policy Division manages the Army energy and water programs. This division executes the Utilities Privatization (UP) Program under delegated authorities from ASA (IE&E). This division also manages the Army Facilities Standardization Committee (AFSC) and operates the Army Energy and Water Report System (AEWRS), PAVER, RAILER, and the BUILDER Sustainment Management Systems. It increases readiness of Army facilities with sustainability policy and technology transfer. The division manages policy, resourcing and oversight for utilities services and commodities, third party investments, energy and water security, and cybersecurity of facility related control systems. The Real Property Asset Management Division, organized into two branches, performs the following functions: provides Army-wide visibility and accessibility to facility, sustainable

management, and service readiness assessment data. Executes and develops the management, analysis, and reporting of installation requirements, funding, and policy through Army systems of record: Real Property Planning and Analysis System (RPLANS), Headquarters Installation Information System (HQIIS), Installation Status Report (ISR), Installation Geospatial Information and Services (IGI&S), and the Army Stationing and Installation Plan (ASIP). Ensures timely and accurate reporting of the Army Real Property Inventory and enhances support to decision-making and programming efforts. Improves facility requirements generation capability. Orchestrates strategic facility initiatives and plans. Plans, executes and manages lifecycle real estate activities and protects real property interests. Achieves comprehensive facility sustainment, restoration and modernization (SRM), leasing, and demolition programming for Active and Reserve Components. The Strategic Plans Division is the ACSIM connection to DCS, G-3/5/7 and the ACP. The division assesses the readiness of Army installations through Army Strategic Readiness Assessments and Strategic Readiness Updates. The division also coordinates force structure, stationing, and joint basing requirements; and, synchronizes support with the Army's Facility Investment Strategy (FIS) and the annual Facilities Investment Guidance (FIG).

(4) The Resources Directorate is the resource proponent for the Army's Installation Management portfolio across all Components (Active, Guard and Reserve). As the II PEG Co-Executive, its mission is to integrate, validate, program and defend resources for installation infrastructure, services, and programs in support of Army Readiness. The directorate also formulates, reviews, integrates and implements Army financial management policy and procedures; ensures financial and performance systems reliability and data accuracy; develops and provides training and support on various databases of record, data sets, costing techniques and formulaic interpretations; ensures audit recommendations pertaining to installation management are completed and synchronized with guidance from audit agencies; maintains Army Regulation 5-9; plans and programs for the annual Army Community of Excellence (ACOE) award program and ceremony; and, administers the OACSIM Manager's Internal Control (MIC) Program. Resources Directorate is made up of three divisions: Program Integration, Requirements Modeling and Financial Management.

#### **16-6. Installation Management Command and other Land Holding Commands**

a. IMCOM is the land holding command in providing installation management services and support at over 71 garrisons, joint bases, communities and sites throughout CONUS and OCONUS in Europe and the Pacific. In addition, although not the land holding command, IMCOM provides various installation management services and support at several Army Reserve, Air Force and Navy owned and managed installations/locations through Army Support Activities.

b. Land Holding Commands are commands with real property maintenance responsibilities that execute installation management and base operations activities. These Commands manage installations and include AMC, Army National Guard (ARNG), Installation Management Command, United States Army Reserve (USAR), and Arlington National Cemetery (ANC).

c. The ARNG executes installation management separately from IMCOM and it occurs at the State-level (e.g., the 50 States, District of Columbia, Puerto Rico, Guam and the Virgin Islands). Each state, district, and territory contracts with the federal government to support the ARNG mission by providing services and facilities. This administration of support contract is through cooperative agreements, whereby the federal government funds the state to provide services in support of the federal share of the mission; the state is responsible for funding their share of costs. The organizational interface between the federal government and the State is provided through the National Guard Bureau (NGB). Each state has an assigned NGB, Title 10 Officer (United States Property and Fiscal Officer – USPFO) who works closely with the state's leadership to assure proper federal reimbursement for state-provided services. Further, each state assigns a Construction and Facility Management Officer (CFMO) that generally manages the state's ARNG facilities and related services. (Note: For all intents and purposes related to this document, the ARNG is comprised of 55 Installations; ie., 50 States, District of Columbia, Puerto Rico, Guam, Virgin Islands and the ARNG Readiness Center in Arlington, VA). IMCOM is the primary active land holding command described below.

d. IMCOM. Army installation "ownership" transferred from some of the functional Army Commands (ACOMs) to the Installation Management Agency (IMA) in 2002. On 24 October 2006, IMA was re-

designated as IMCOM and installation management roles and responsibilities were assumed by HQ IMCOM.

(1) HQ IMCOM is located at Joint Base San Antonio, Texas. As a Direct Reporting Unit (DRU), IMCOM is accountable to the CSA for effective garrison support of mission activities, and serves as the active Army's primary provider of base support services. The five IMCOM directorates are each led by a Senior Executive Service (SES) government employee serving as an IMCOM Directorate Director reporting directly to the IMCOM commander. IMCOM's mission is to integrate and deliver base support to enable readiness for a globally-responsive Army. HQ IMCOM, directorates, and garrisons provide comprehensive installation analysis to DCS, G3/5/7 for feasible unit stationing.

(2) IMCOM Directorates implement, direct, and oversee policy and program execution. They support garrisons by being responsible for enforcing Army-wide standards and ensuring equity among installations, adopting best business practices, identifying and implementing efficiencies and partnerships, and interfacing with ACOMs, Army Service Component Commands (ASCCs), DRUs, and other Services and/or agencies.

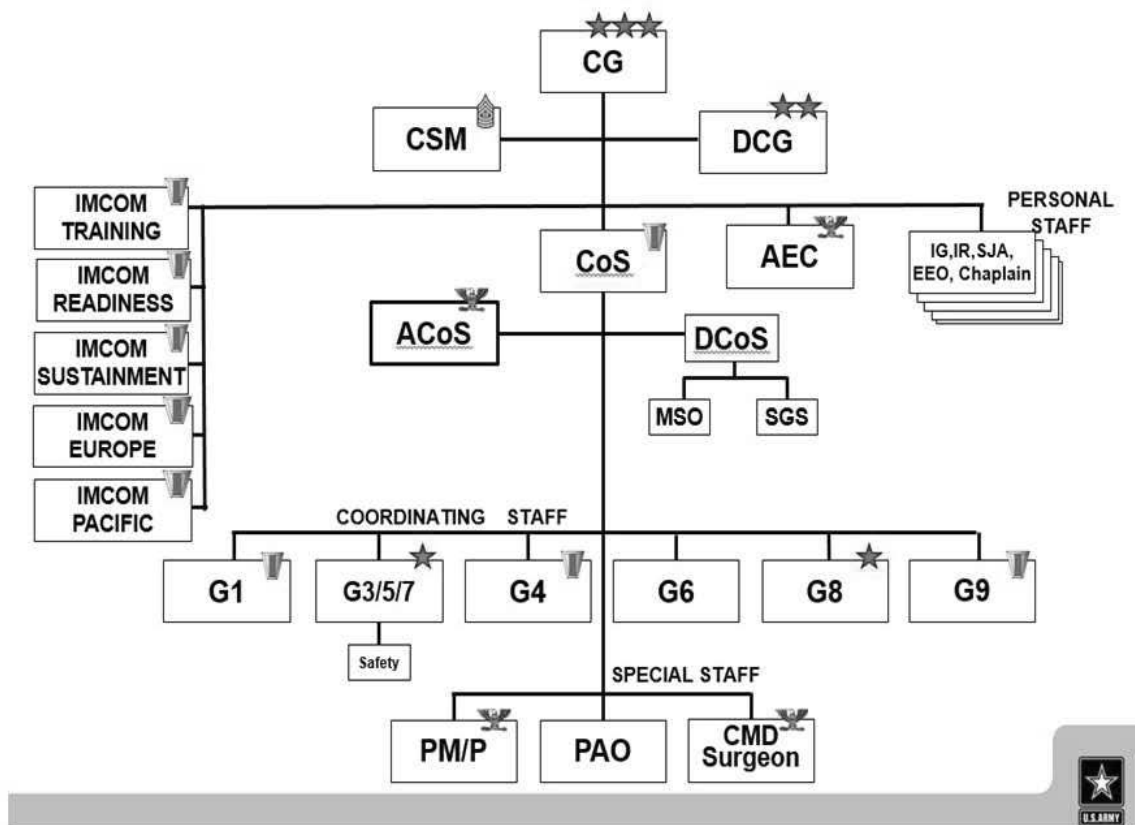

**Figure 16-2. Installation Management Command**

(3) Each Army installation has a garrison command reporting to an IMCOM Directorate. GCs support and enable Senior Commanders (SC). The GC integrates and synchronizes garrison services, following command and control, by providing installation and base support services to all local units, tenants and customers.

(4) IMCOM garrisons provide the full range of installation support services with the exception of Base Operations Support (BASOPS) logistics services.

(5) The GC roles and duties are described in Army Regulation 600-20 and further described below as it related to the SC. The GC is supported by the Deputy GC, retained as a civilian position, to provide continuity for the garrison and its supported population.



e. **SC/GC Roles and Responsibilities.** The SC is normally, but not always, the senior General Officer (GO) at the installation. The SC's mission is care of Soldiers, Families, and Civilians, and to enable unit readiness. While delegation of senior command authority is direct from HQDA, the SC will routinely resolve installation issues with IMCOM and, as needed, the associated ACOM, ASCC, or DRU. The SC's higher headquarters (i.e., ACOM, ASCC, or DRU), on behalf of HQDA, will maintain oversight of the SC while executing installation missions. The SC uses the garrison command as the primary organization to provide services and resources to customers in support of accomplishing this mission. All applicable commands support the SC in execution of SC responsibilities; therefore, the SC is the supported commander by IMCOM, other installation Service providers, and tenants. The SC is responsible for synchronizing and integrating Army priorities, initiatives and sustainable readiness at the installation. On IMCOM-managed installations there is a requirement for a strong collaborative relationship between the SC and IMCOM Director (IMCOM-Training, IMCOM-Readiness, IMCOM-Sustainment, IMCOM-Pacific, and IMCOM-Europe). The SC commands the installation but funding of almost all BASOPS activities flows through IMCOM.

f. The GC is a military officer, lieutenant colonel (LTC/O-5) or colonel (COL/O-6), selected by HQDA. The GC commands the garrison, is the SC's senior executive for installation activities, is rated by the IMCOM Director, and is senior rated by the SC. The GC is responsible for day-to-day operation and management of installations and base support services. The GC ensures that installation services and capabilities are provided in accordance with (IAW) HQDA-directed programs, SC guidance, CLS, and IMCOM guidance. The GC provides additional service support IAW HQDA directives and provides reimbursable services in accordance with memorandum of understanding (MOU) or memorandum of agreement (MOA) and/or installation support agreements. The GC is responsible to deliver Family and installation programs, coordinates and integrates delivery of support from other Service providers, and obtains SC approval of the installation master plan. The GC may be appointed by the SC as a Summary Courts-Martial Convening Authority or Special Courts-Martial convening authority for the installation and its support area; in rare cases the GC may be appointed as GCMCA. In some cases, the senior official on an installation may be the garrison manager. A garrison manager (Civilian equivalent of a GC) has the same responsibility and authority as the military counterpart with exception of UCMJ and command authority. Prior to the appointment of garrison manager, command and UCMJ authorities for the garrison will be specified. The GC responsibilities are as follows:

- (1) Represents the Army and installation in the surrounding community as directed by the SC.
- (2) Approves and issues garrison policies in accordance with respective Army regulations, or installation level policies involving tenant units as directed by the SC.
- (3) Implements policies for the IMCOM Civilian workforce.
- (4) Develops and implements an Integrated Protection Plan incorporating functional elements of the Army Protection Program (anti-terrorism, critical infrastructure risk management, emergency management, physical security, law enforcement, fire and protection services, and continuity of operations).
- (5) Supports mobilization station requirements.
- (6) Integrates all installation services on the installation by all Service providers.

g. The ACOM, ASCC, or DRU commanders on IMCOM-managed installations:

- (1) Provide to IMCOM a prioritized list of military construction, Army/military construction, Army Reserve projects and requirements that impact subordinate units to support development of the military construction program and the program objective memorandum (POM).
- (2) Provide IMCOM with subordinate mission priority requirements for military construction and base operations.
- (3) Identify to IMCOM, through the CLS process and other requirements development processes, the required levels of garrison support needed to meet mission requirements. Also, identify to IMCOM any support requirements not included in CLS services. Collaborate with IMCOM in developing garrison support requirements that are applicable to all garrisons.
- (4) Evaluate the effectiveness of installation services and support and participate in prioritization of these services and support.
- (5) Responsible for mobilization of subordinates as specified in Army Regulation 10-87 and HQDA Execute Orders (EXORDs).
- (6) Provide prioritization requirements for information technology and training enabler support to IMCOM.

(7) Commands with personnel residing on installations, whether on a permanent or temporary basis, will support and comply with the FP actions of the garrison as directed by the SC.

(8) Will follow command responsibilities for the Total Army Sponsorship Program as stated in Army Regulation 600–8–8 and related official guidance.

(9) Provide IMCOM with critical infrastructure function, criticality, and protection requirements of critical infrastructure located on IMCOM installations and critical infrastructure needed for support located off IMCOM installations.

h. Installation Readiness.

(1) Installation Readiness is achieving mission excellence through streamlined processes, strategic partnerships, and good stewardship of resources that address Army priorities and meet mission requirements of SCs. It translates into the ability to provide a growing and transforming Army with the infrastructure and support services it needs to remain a highly effective, expeditionary and campaign-quality force, today and in the future.

(a) Installations are readiness platforms that enable Commanders to project power and mobilize forces in support of the National Military Strategy (NMS). As readiness platforms, installations provide support to the warfighter through facilities and services that allow the Army to exercise mission command, collect/process intelligence, train, maintain, arm, protect, house, mobilize, deploy, and receive forces to fight and win. The CSA directed revision of the Army Strategic Readiness Assessment (ASRA) to assess the Army's ability to meet NMS demands through seven tenets. The OACSIM established readiness measures and indicators to assess Installation Tenet readiness risk through three Lines of Effort (LOE): Mission Readiness, Soldier and Family Readiness, and Installation Capacity. The first assessment focus on facility readiness is achieved through a collaborative approach between HQDA and commands to identify poor and failing facilities that most drive readiness in order to inform Senior Leader policy and resourcing decisions.

(b) The Facility Readiness Drivers (FRD) framework was established in 2017 and enables the Army to focus readiness reporting and optimize facility investments based upon commanders input. HQDA EXORD 265-17, dated 3 August 2017, is a three-phased effort directing ACOMs, ASCCs, and DRUs identify poor and failing facilities by relative impact to readiness. FRDs tier identification will be maintained in an Army system of record that supports installation readiness reporting. The FRD framework will give Army Senior Leaders an enhanced view of installation readiness that informs resourcing and policy decisions. Future development will enable installations to articulate readiness risk in Installation Capacity and Soldier and Family Readiness. This progress improves the Army Installation community to better articulate association to readiness.

(2) Sustainability is a major facet of installation readiness. Today, interdependence between mission excellence, energy security, environmental stewardship and community relations has never been more important. The installation community has produced an Energy Portfolio, Water Portfolio, and Environmental Portfolio which recognizes successes at installations in each of these areas. The community has emplaced a strategy of environmental sustainment through everyday actions and through education, incentives and alternatives. IMCOM collaborates with industry and ACOMs to establish installations that are more energy efficient and self-sustaining than in the past. The Army Net Zero Program is key for this effort. IMCOM continues to work with community partners as it pursues sustainability in long range goals, addresses encroachment issues and reaffirms installations as valued neighbors. IMCOM will continue to modernize installation training facilities to support unified land operations training. IMCOM supplies training areas and facilities that provide Soldiers with realistic experiences, thoroughly preparing them for all contingencies. IMCOM will continue to focus attention on current and emerging technologies, leveraging opportunities to conserve energy, promote water conservation, reduce waste, preserve natural resources, enhance training realism, and reduce supply chain vulnerability.

(3) SCs, GCs, leaders, and staff at installations understand their local circumstances in order to make decisions regarding all hazards and threat assessments, risk management, protection and response planning, training, exercising; and, assessing allocation of protection-related resources at their installations. The Army Protective Posture (APP) management structure consists of APP Board of Directors (APPBOD), APP General Officer Steering Committee (APPGOSC), APP Council of Colonels

(APPCoC), and associated working groups. At the HQDA level, the APP expands program oversight, ensures senior leader accountability, and facilitates informed decision making and resource allocation. ACSIM and IMCOM have representatives attending each of the APP bodies. IMCOM, through the Provost Marshal/Protection Division, supports the APP operational objectives which serve as the primary means for the Army to support execution of the DOD Mission Assurance Strategy as it applies to installations. The APP is comprised of the following non-war fighting functional elements and associated enabling functions found on Army installations: Antiterrorism, Continuity of Operations, Critical Infrastructure Risk Management, Emergency Management, Fire and Emergency Services, Law Enforcement, Physical Security, Information Assurance and OPSEC.

i. Establishing Standards. The Army's installation long-range plan conveys direction for installation management during the next 20-plus years. The plan identifies efficiency programs, determines funding requirements, and describes metrics used to measure success. The goal of the plan is to provide quality, cost-effective, and efficient mission-ready installations that are the right size, in the right place, and available when needed. Management planning for installations focuses on streamlining, realigning and standardizing services and the workforce, recapitalizing investments and reducing costs. For this purpose, ACSIM acts for and exercises authority of the CSA in dissemination of policy and integration of doctrine pertaining to the operation of Army installations. The ACSIM is responsible for establishing performance metrics and implementing Army-wide standards for installation management and BASOPS.

j. ACOE Program.

(1) The ACOE program is conducted by the three Army components: Active Army (IMCOM), National Guard (NGB), and the Army Reserve (U.S. Army Reserve Command (USARC)). The ACOE program is sponsored by the CSA and overseen by the ACSIM IAW Army Regulation 5-1. The ACOE program recognizes excellence at Army installations by assessing all components and dimensions of installation management consistent with the Army mission and CSA priorities. The ACOE program is an incentive for commanders to self-assess their progress toward achieving goals for installation management success.

(2) The ACOE program objective is to improve installation operations and readiness. The program encourages the use of integrated management systems and existing models, such as ISR and Interactive Customer Evaluation (ICE) system reports, that enable leadership to make resource-informed decisions and provide trained and ready forces at best value by identifying management strengths and key areas for improvement. The ability to measure success is essential to achieving high levels of performance. The ACOE program is a multiyear/component program that spans the current year, prior year, and one out-year.

(3) The ACOE program culminates with an annual ACOE award ceremony officiated by the CSA or VCSA, and planned and programmed by the ACSIM. The ACOE Award honors top Active Army, National Guard, and Reserve garrisons and installations that have achieved high levels of excellence in building a quality environment, outstanding facilities, and superior services. During a year-long process, ACOE award applicants are assessed by their command/component headquarters and evaluated against Army priorities and benchmarks.

(4) Each of the three Army components is responsible for evaluating ACOE submissions and arranging attendance for the ACOE award ceremony at the Pentagon. Out-year dollars are presented to winning communities in the first quarter following the competition. The program places emphasis on installations striving for greater excellence in facilities and services which significantly contributes to readiness. Award nomination packages and best business practices are shared with the IMC and maintained on an ACSIM Resources Directorate SharePoint site. The Active Component ACOE winner is submitted for the Army's DOD Commander-in-Chief Annual Award for Installation Excellence, which recognizes outstanding and innovative efforts of the people who operate and maintain U.S. military installations. The five recipients from each military service of this highly competitive Presidential award are selected for their exemplary support of DOD missions.

k. MILCON.

(1) A viable standard process for determining Mission/Base Operations military construction projects is a fundamental condition for the success of managing installations to standards. The streamlined components of this process include the following actions—

- (a) GC forwards the SC's prioritized listing of all projects to IMCOM Directorates.
- (b) IMCOM Directorates prioritizes all BASOPS projects within their span and forwards to HQ IMCOM.
- (c) HQ IMCOM prioritizes all BASOPS projects and forwards to ACSIM.
- (d) ACOM, ASCC, DRU prioritize their mission projects and forward prioritizations to ACSIM.
- (e) ACOM, ASCC, DRU may offer their suggested prioritization of BASOPS projects for installations where the SC reports to the ACOM, ASCC or DRU. This suggested prioritization would be forwarded to ACSIM and IMCOM.

(2) Upon receipt of prioritized project listing from ACOMs, ASCCs, DRUs, and HQ IMCOM and using guidance provided by Senior Army Leadership, ACSIM and DCS, G-3/5/7 co-chair the MILCON Integrated Programming Team (IPT) which builds the recommended Army prioritized project list. ACSIM/DCS, G-3/5/7 provides the recommended prioritized project list to the Undersecretary of the Army (USA) and the Vice Chief of Staff, Army (VCSA) for approval. MILCON projects are funded within available fiscal constraints.

### 16-7. Installation Readiness Board of Directors (IRBOD)

a. The IRBOD is an advisory body that makes recommendations regarding major strategic initiatives, plans, and programs pertaining to Army facilities, installation infrastructure, installation services (including military construction, exchange and commissary services, logistic services, training support, medical support, information technology, and housing and lodging) and Morale, Welfare, and Recreation programs. The IRBOD is responsible to the SecArmy and CSA for identifying required policy, programming, and resourcing changes for ARSTAF development and approval. It replaces the function of the MWRBOD to include integration and synchronization of all programs, policies, and initiatives pertaining to Army installations. The IRBOD is tri-chaired by the VCSA, ASA (M&RA), and ASA (IE&E). The tri-chairs will assess whether installation and MWR programs critical to Soldier and Family readiness receive appropriate emphasis and oversight. The IRBOD recommends decisions including, but not limited to, the following issues:

- (1) Establishing strategic goals, objectives, and standards for programs and operations.
- (2) Establishing strategic guidance and investment priorities that define effective performance, enable installation readiness, and optimize resources and programs needed to implement and monitor the strategic plan.
- (3) Establishing, monitoring, and influencing performance measures for programs and operations that address critical readiness shortfalls and optimize installation programs, policies, and performance.
- (4) Reviewing and approving, or endorsing, BASOPS actions and proposals that have Army-wide impact. These actions include but are not limited to determining new standards for service delivery and/or changes to the types and amount of services provided.
- (5) Approving and prioritizing, within available funding levels, non-appropriated fund (NAF) construction projects for inclusion in the annual DOD Report to Congress on the NAF major construction program.
- (6) Providing fiduciary oversight for Army MWR and all NAFs.
- (7) Reviewing, endorsing, and conducting inter- and intra-agency coordination of those actions that cannot be resolved within the Army (e.g., non-Army tenants on installations).

b. The IRBOD is intended to incorporate and broaden functional responsibility of the chartered Morale, Welfare, and Recreation Board of Directors (MWRBOD) and the unchartered Services and Infrastructure Core Enterprise (SICE) Board, providing a single forum to address all installation readiness functional components. The MWRBOD was established in 2011 to function as a governing body to review and approve major management strategies, plans, and programs pertaining to Moral, Welfare, and Recreation (MWR) programs and non-appropriated fund instrumentalities. The SICE Board replaced the Soldier and Family Readiness Board (SFRBOD) in 2010.

c. The IRBOD is a principal official-level body (3- and 4-Star) and includes a supporting General Officer Steering Committee (GOSC) (2- and 3-Star deputies or equivalent) and supporting Council of Colonels

(CoC). IRBOD tri-chairs may adjust membership as necessary. Additional ARSTAF representation is requested as appropriate, or when agenda dictates.

### Section III Initiatives and Programs

#### 16-8. Major Installation Management Initiatives and Programs

a. The Service Culture Initiative (SCI) is a continuous campaign that IMCOM utilizes to instill a culture (shared value) of service excellence within all facets of IMCOM services. IMCOM determined that a service culture is vital to help the Army adapt to a changing environment characterized by reduced resources to maintain or enhance readiness requirements. The SCI indoctrinates a culture of service excellence through leader and workforce engagement, an on-boarding program that welcomes and fully integrates all newly assigned Soldiers and Civilians to IMCOM, an employee recognition program that effectively furthers the missions, goals, and values of the Army, and a standardized customer service training implemented garrison-wide. The SCI, and its pillars, help IMCOM carry out its unique mission in support of the Chief of Staff of the Army's effort to adjust Army culture; focusing on the Army as a profession, individual self-reliance, empowerment, commitment to service, community well-being, and taking care of each other.

b. Common Levels of Support (CLS) is IMCOM's enterprise platform by which IMCOM delivers, tracks, and reports performance measures with a singular focus on achieving the highest levels of readiness and with the greatest efficiency IAW Army Business Strategy 2017-2021. CLS defines common BASOPS support services, subtasks (Service Support Programs (SSPs)), and performance targets establish standards for service delivery and measure performance. CLS provides the SC and GC the ability to:

- (1) Deliver the right level of service with a capability to predict resources needed; and a method to plan, execute, track and compare performance.
- (2) Articulate definitive performance guidance to garrisons for the execution of core services delivered to standard, based on available funding.
- (3) Distribute available resources among installations to execute guidance.
- (4) Measure garrison performance to make sure that expected performance is being achieved.
- (5) Inform customers on levels of support they can expect from Garrisons across the Army.

CLS is built on the principle that IMCOM installations will provide non-reimbursable BASOPS to Army customers across all its installations. This support will be standard but adaptable to local realities for the installation (e.g., requirements of mission, demography, or geography). Garrisons are required to deliver installation management support services IAW with the Army's ISR - Services program, which specifies content and pacing measures for each service component. The total dollar requirement for garrisons to deliver these services is calculated to fund the full scope of service as defined in the ISR. However, garrisons historically do not receive 100 percent of required dollars for each service. Garrisons therefore cannot deliver the full scope of services, and must have some way of determining which service components can be delivered with the dollars available. CLS provides an approach for making this decision across the Army, in a way that will lead to quality, consistency, and predictability.

c. Installation Service Standards (ISS). The effort to develop Army Baseline Standards performance-based measures initially focused on those ISR services where the quality of the service provided was key to determining required resources and so potential performance measures could easily be identified. For these services, quality played a significant role and required supplemental data from Army Service Based Costing (SBC) - a model to capture the cost of base operations at the service level - to facilitate development of good cost estimating relationships (CER) for resource program development purposes. This ongoing effort will result in performance measures and standards for all 95 standard services developed by the Army Baseline Standards Task Force appointed by the ACSIM in fiscal year 2015. The intended result is a Published Installation Services Directory identifying services and providers, to include established baseline standards, applicable regulations, performance and pacing measures (cost drivers)

that provide for common service expectations; clearly defined non-reimbursable service standards that more accurately inform POM requirements (valid and defensible).

d. Installation status report (ISR). The ISR Program assists Army leadership in making informed and responsible decisions required to sustain or improve management of installation facilities, mission support capabilities, and services. The program provides HQDA, ACOMs, ASCCs, DRUs, and leadership of reporting installations with executive level information focused on the installation's real property assets, and installation support services. The ISR is comprised of three components:

(1) ISR Infrastructure. The purpose of ISR infrastructure is to document and display an ISR reporting installation's infrastructure status by assessing the quantity of facilities available for installation requirements and comparing the quality of installation facilities to established Army standards.

(2) ISR Mission Capacity (ISR-MC) focuses on two program areas: Mission Support and Sustainability. It is designed to provide leaders at all levels with a decision support tool that links leading indicators to mission support and sustainability capabilities. ISR-MC provides an objective analysis of a reporting organization's ability to support mission requirements based on availability and capability of land, air, energy, and water resources.

(3) ISR Services focuses on evaluating quality, efficiency, and availability of services provided on an installation. Since July 1993, OACSIM has used Installation Status Report Services (ISR-S) performance and cost data as the basis for developing BASOPS requirements. The ISR program provides an overall picture of an installation's status and shows how deficiencies in installation condition affect the mission performance. It provides information which links installation conditions, priorities and resources to readiness. While serving the needs of different customers—HQDA, ACOMs, ASCCs, DRUs, and installations—the ISR is also the installation commander's opportunity to influence the Army's Installation Management Strategy. The ISR provides a common standard and language for the Army to speak with one voice. Details concerning the ISR are contained in Army Regulation 210-14, Installation Status Report Program. Additionally, ISR data supports HQDA decisions on funding for the Army Strategic Readiness Reporting (ASRA).

e. The Facility Investment Strategy (FIS) is a holistic approach to improve facility quality which includes investments to sustain enduring facilities, improve existing facility conditions particularly energy and utility efficiencies, to demolish facilities no longer needed, and to build to address critical shortfalls. The Army will use all forms of facility investment to include Unspecified Minor Military Construction, Army (UMMCA), O&M (R&M) and expend MILCON when MILCON is the best alternative. The Army will use the ISR and RPLANS to measure investment results.

f. Core Capabilities.

(1) Installation Services. We will provide a quality of life commensurate with the quality of service provided by Soldiers and their Families. We plan for a future of delivering facilities and services that are flexible and adaptive to support the Operating and Generating Forces. Army-wide standards for service delivery will be customer-driven, leverage successful partnerships with communities and the private sector, enable mission accomplishment by SCs, and enable well-being and readiness for Service members and Families. Services will be provided based on an enterprise business model and reflect enterprise standards, priorities, and funding strategies intended to eliminate redundancies.

(2) Installation Infrastructure. We will provide infrastructure to enable the Army to accomplish its mission on a global scale and achieve Army standards for quality and capacity at least cost. In 2025, Army installation infrastructure should be secure and sustainable. Energy and environmental programs will be models for surrounding communities across the globe. Our facilities will enable a quality of life commensurate with the quality of service provided by our Soldiers and their Families and help to mitigate the stress of repeated operational deployments on people, equipment, and infrastructure. We will work as an enterprise to properly station the force and adjust the Army's global infrastructure to enable the Army to fulfill its training and operational mission, and execute requirements of the Defense Strategy.

(3) Installation Synchronization—People, Processes, and Tools. Inspired installation leaders will seek to use innovative approaches built on lessons learned and institutionalize best practices of benchmark organizations within and outside of Army and DOD. Installation Leaders will use performance

management, geo-spatial, financial management, and communications tools to meet Army requirements and facilitate enterprise management. Internal installation functions will be streamlined and focus on core competencies of installation services and installation infrastructure. Installations will work within the Army Management system, pursue vigorously public-public and public-private partnership opportunities, and will employ processes that develop and sustain the workforce and create a true Installation Profession. Installations will have many organizations responsible for providing services as an enterprise, and installation leaders will coordinate and synchronize all service providers to ensure integrated, balanced and efficient service delivery.

## Section IV Summary and References

### 16-9. Summary

The IMC concept provides effective Army-wide installation management through use of best corporate business models, development of relevant standards and comprehensive adherence to Army standards, and partnership with ACOMs, ASCCs, and DRUs, senior and mission commanders, who receive focus on their unique issues, while geographic efficiencies are realized through economies of scale. The concept cares for people while ensuring readiness is not compromised; it positions installations for Army and DOD transformation initiatives and represents the Army's commitment to improve installations, preserve the environment, enable well-being of Soldiers, civilians and family members, and support mission readiness of all stakeholder units.

### 16-10. References

- a. Publications—
  - (1) 2017 Army Campaign Plan (ACP).
  - (2) Army Regulation 1-1, Planning, Programming, Budgeting, and Execution System, 23 May 2016.
  - (3) Army Regulation 5-1, Management of Army Business Operations, 12 November 2015.
  - (4) Army Regulation 5-9, Area Support Responsibilities, 16 October 1998.
  - (5) Army Regulation 5-10, Stationing, 20 August 2010.
  - (6) Army Regulation 10-87, Army Commands, Army Service Component Command, and Direct Reporting Units, 11 December 2017.
  - (7) Army Regulation 115-11, Geospatial Information and Services, 28 August 2014.
  - (8) Army Regulation 200-1, Environmental Protection and Enhancement, 13 December 2007.
  - (9) Army Regulation 210-14, Installation Status Report Program, 19 July 2012.
  - (10) Army Regulation 210-20, Real Master Planning for Army Installations, 16 May 2005.
  - (11) Army Regulation 405-70, Utilization of Real Property, 12 May 2006.
  - (12) Army Regulation 405-90, Disposal of Real Estate, 10 May 1985.
  - (13) Army Regulation 420-1, Army Facilities Management, 12 February 2008 (Rapid Action Revision Chapter 25, 24 August 2012).
  - (14) Army Regulation 420-41, Acquisition and Sales of Utilities Services, 3 March 2015.
  - (15) Army Regulation 600-3, The Army Personnel Development System, 26 February 2009.
  - (16) Army Regulation 600-8-8, The Total Army Sponsorship Program, 4 April 2006.
  - (17) Army Regulation 600-20, Army Command Policy, 6 November 2014.
  - (18) Department of the Army General Order 2017-01, Assignment of Functions and Responsibilities within Headquarters, Department of the Army, 5 January 2017.
  - (19) Department of the Army General Order 2015-05, Designation of the U.S. Army Installation Management Command as a Direct Reporting Unit of the Chief of Staff, Army, 23 October 2015.
  - (20) Department of the Army Pamphlet 5-13, Procedures for Army Stationing, 3 June 2015.
  - (21) Installation Management Community Campaign Plan.
  - (22) Office of Management and Budget (OMB) Circular A-76 (Revised), Performance of Commercial Activities.

- b. Useful Links—

## HOW THE ARMY RUNS

- (1) Deputy Under Secretary of Defense for Energy, Installations & Environment (DUSD (EI&E))  
<http://www.acq.osd.mil/eie>.
- (2) Assistant Secretary of the Army for Installations, Energy & Environment (ASA (IE&E))  
<http://www.army.mil/asaiee>.
- (3) Assistant Chief of Staff for Installation Management (ACSIM) <http://www.acsim.army.mil>.



## Chapter 17

### Army Health System

#### Section I Introduction

##### 17-1. Chapter Content

This chapter covers the Army Medical Department mission and support to commanders, the Army Health System's (AHS) key elements, relationships, and responsibilities, and command and management within the Army Medical Department, Medical Command, Regional Health Commands, and Army Health Readiness Center of Excellence.

##### 17-2. The Evolution in Military Medicine

The strategic environment is one of complex interdependence and contains two major parts. First, the environment in general includes various political, economic, and social forces that are not unique to Army Medicine or the federal government. Second, the Army Medicine organizational context includes both the Army and the Military Health System (MHS). Healthcare in the U.S. is at a critical juncture, and there is an opportunity for Army Medicine to lead the Nation away from the status quo. Advances in technology not only provide promise for improving the efficacy and delivery methods of healthcare, but new methods of communication will redefine how individuals connect with one another, with partners, and with patients. Additionally, increased data-collection and analysis provides new opportunities for intervention and understanding. The Army Medicine Campaign Plan (AMCP) 2017 which supersedes the Army Medicine 2020 Campaign Plan, expresses the comprehensive organizational strategy for U.S. Army Medical Command (MEDCOM) and the Office of The Surgeon General (OTSG) to fulfill the Army Medicine Vision. AMCP 2017 outlines an operational approach that portrays the broad actions that Army Medicine must take to transform current conditions into those desired at the end state. Army Medicine will operate on the following four lines of effort (LOE) to achieve its desired end state—

- a. LOE 1 Readiness and Health. Army Medicine must be agile, adaptive, flexible, and responsive to Warfighter requirements, properly postured to deploy healthy individuals and organizations in support of the world's premier combat force.
- b. LOE 2 Healthcare Delivery. From the battlefield to the garrison environment, Army Medicine will support the Operational requirements of Combatant Commanders while also ensuring the delivery of the healthcare benefit to all beneficiaries.
- c. LOE 3 Force Development. Army Medicine must rapidly develop scalable and rapidly deployable medical capabilities that are responsive to Operational needs and are able to effectively operate in a Joint/Combined environment characterized by highly distributed operations and minimal, if any, pre-established health service infrastructure.
- d. LOE 4 Take Care of Ourselves, our Soldiers for Life, DA Civilians, and Families. Army Medicine will continue to take care of the Force, Soldiers for Life, Service Colleagues, DA civilians, and service members' Families.

##### 17-3. Scope of the Army Medical Department

The Army Medical Department (AMEDD) encompasses those Army special branches that are under the supervision and management of The Surgeon General (TSG). Specifically, these special branches are the Medical Corps (MC), Dental Corps (DC), Veterinary Corps (VC), Medical Service Corps (MS), Army Nurse Corps (NC), and Army Medical Specialist Corps (SP). The AMEDD is one of the world's largest health systems and includes all roles of medical, dental, veterinary, and other related healthcare from policy and decision-making to the combat medic in the field.

- a. TSG of the Army is dual-hatted as a principal staff officer of the Headquarters, Department of the

Army (HQDA) and as the Commanding General (CG) of the Army's largest active duty direct reporting unit, MEDCOM.

b. TSG advises the Chief of Staff of the Army (CSA) on the development, policy direction, organization, and overall management of the AHS.

c. TSG also monitors and manages health services Army-wide through the OTSG, the AMEDD-element of the Army Staff (ARSTAF). Hand-in-hand with other Army management processes (Total Army Analysis (TAA), Planning, Programming, Budgeting, and Execution (PPBE)), the AMEDD conducts various programs specifically designed to meet the force modernization, unit readiness, research and development, preventive medicine, and patient care missions for the armed forces.

d. As the MEDCOM's Commanding General, TSG possesses command authority over 69,000 healthcare personnel and hundreds of generating force health readiness organizations and platforms.

e. Through the Warrior Transition Command (WTC), the AMEDD is responsible for every aspect of the Army's Warrior Care and Transition Program which provides a holistic patient and family-centered approach to recovery, rehabilitation, and reintegration of wounded, ill, and injured Soldiers.

### 17-4. Army Health System Support

The AHS and Army medical and dental benefits are an important element of overall military compensation. Providing comprehensive and quality healthcare to military personnel is required by law. Other eligible Army Medicine beneficiary categories, such as retirees and family members, are entitled to medical and dental care subject to availability of space, facilities, and medical and dental staff as defined by Title 10 of the United States Code (USC) and other regulatory requirements. Health services are essential to recruiting and retaining a quality force. Soldiers' confidence and performance on the battlefield is enhanced knowing that they and their family members are supported by a superb health readiness system. The System for Health (SfH) is a critical enabler in the human dimension and Ready and Resilient Campaign (R2C), both of which result in optimized human performance, health readiness, resilience, and overall personal health. SfH develops engaged and empowered beneficiaries to take personal responsibility to improve, restore, and maintain the health of the Total Army Family. The SfH is a comprehensive, synchronized, integrated, responsive, and reliable system to improve readiness, save lives, and optimize health in support of all service members, retirees and their families. The concept of complete Soldier "life cycle health management" begins during accession and initial entry training, and then extends throughout the cycles of stationing and deployment and/or redeployment until transition or separation from the Army. SfH embodies the concept that the Army cares for its own and is capable of strengthening the health of the nation by improving the health of the Army.

### 17-5. Medical Support to the Transforming Army

a. Army Medicine is transforming from a healthcare system to a system for health. Army Medicine consistently delivers evidenced-based and value-added services to our beneficiaries, improves existing health readiness programs and services, and develops new processes and initiatives to improve the health of the populations entrusted to our care. This includes engaging people where they live, work, and socialize (e.g., the Lifespace) in addition to traditional patient care settings, affecting the determinants of health and improving Army readiness.

b. Army Medicine progress in attaining the SfH will be achieved along 4 Lines of Effort (LOE):

(1) LOE 1 – Combat Casualty Care (CCC): defined as the continuum of medical treatment from the point of injury through successive roles of medical or veterinary medical care to definitive, rehabilitative, convalescent, and transition care. CCC is supported by Army Medicine personnel, services, and doctrine that saves lives and maintains the health readiness of our service members and military working animals.

(2) LOE 2 – Ready and Deployable Medical Force: defined as Army Medicine personnel who are professionally developed and resilient to leverage the capabilities provided by joint, interagency, intergovernmental and multinational (JIIM) partners to provide the highest level of health readiness to the Total Army Family. Army Medicine enables the geographic combatant commander's (CCDR) and Army Service Component Command (ASCC) commander's requirements by providing trained and ready medical and veterinary medical personnel.

(3) LOE 3 – Health Readiness of the Force: defined as Soldiers and military working animals who exhibit and meet readiness requirements to execute any mission in an increasingly complex world. Mission Command (MC) demands that Soldiers have an increased strategic focus and shorter decision making capability for the Army to prevent, shape, and win wars. Army Medicine enables health readiness

and optimal performance of the Total Army by maintaining, restoring, and improving the physical, emotional, and cognitive dominance of Soldiers.

(4) LOE 4 – Health of Families and Retirees: defined as a state of complete physical, mental and social well-being, not merely the absence of disease or infirmity. Providing healthcare and promoting the health of the Total Army Family members, including retirees, is a privilege and a promise. This capacity enables Army Medicine's capability to train, deploy, and render combat casualty care. Army Medicine will continue to lead the way to meet the ever-changing needs of the future in health readiness for both our Soldiers and our families.

## Section II

### Army Medical Department Mission and Support to Commanders

#### 17-6. Mission of the Army Medical Department

The mission of the AMEDD is to “maintain the health of members of the Army, to conserve the fighting strength, to provide healthcare for eligible personnel, and to provide health support to members of the Army in war, international conflict, or natural disaster.” This mission relates directly to Army combat readiness. The AMEDD is responsible for maintaining the clinical, technical, and combat readiness of medical units and personnel to support forces in the theater of operations. As a component of the MHS the AHS is responsible for operational management of the health service support (HSS) and force health protection (FHP)

missions for training, pre-deployment, deployment, and post-deployment operations. It includes all mission support services performed, provided, or arranged by the Army Medical Department to support health service support and force health protection mission requirements for the Army and as directed, for joint, intergovernmental agencies, coalition, and multinational forces. The AHS includes all mission support services performed, provided, or arranged by the AMEDD to support HSS and FHP mission requirements for the Army and as directed, for joint, intergovernmental agencies, coalition, and multinational forces.

a. HSS is defined as all support and services performed, provided, and arranged by the AMEDD to promote, improve, conserve, or restore the mental and physical well-being of personnel in the Army and as directed in other services, agencies, and organizations. This includes casualty care, medical evacuation, and medical logistics, which encompass a number of AMEDD functions—organic and area medical support, hospitalization, the treatment aspects of dental care and behavioral health (BH) and/or neuropsychiatric (NP) treatment, clinical laboratory services, and the treatment of Chemical, Biological, Radiological, Nuclear, and High-Yield Explosive (CBRNE) patients.

b. FHP is defined as measures to promote, improve, or conserve the mental and physical well-being of Soldiers. These measures enable a healthy and fit force, prevent injury and illness, and protect the force from health hazards. This includes the prevention aspects of a number of AMEDD functions, as follows: preventive medicine, such as medical surveillance and occupational and environmental health surveillance; veterinary services, including the food inspection and animal care missions; the prevention of zoonotic diseases transmissible to man; combat and operational stress control; dental services (e.g., preventive dentistry); and laboratory services (e.g., area medical laboratory support).

(1) The deployable medical units of the Army carry out FHP, with a heavy reliance on the Reserve Components (RC) medical capabilities. These units are apportioned to combatant commands (CCMD) around the world.

(2) The AMEDD is also chartered to deliver healthcare to Soldiers and family members at Medical Centers (MEDCEN), community hospitals, and medical clinics, dental clinics, and veterinary services; medical research and development; education and training, rehabilitative care and training; and health promotion and preventive medicine. Fixed installation TDA medical units assigned to the AMEDD directly support operational units on an area basis as it relates to medical equipment and training of assigned medical personnel.

(3) The recruitment and retention of healthcare professionals and sustainment of their skills are central to the maintenance of a high-quality medical force. Deploying the medical force is one of the AMEDD's primary missions. In peacetime, the vast majority of healthcare professionals and technical support personnel who deploy with medical units are employed within the Army's fixed hospitals, MEDCENs, and other healthcare facilities. The day-to-day practice of healthcare professionals and their support staff in

these environments is the basis for maintaining the clinical skills and teamwork necessary to care for sick and wounded Soldiers during operations.

c. **Beneficiary Care and TRICARE.** The second but equally important aspect of the AMEDD mission is to help maintain the personnel readiness of the Total Army by maintaining the health of individual Soldiers and their families.

(1) Quality healthcare for Soldiers, retirees, and their families is an essential and valuable benefit. Physical readiness, good health, and the knowledge that family members will be cared for, contribute to the ability of each Soldier to deploy and perform their mission in the operational environment (OE).

(2) To meet readiness requirements and serve Soldier and family health needs better, Congress directed the DOD to develop and implement a new model for military healthcare that would improve patients' access to healthcare, assure high quality of care, and control rising healthcare costs. The result, TRICARE, is now the medical program for active duty service members, retirees, and their families, and eligible survivors of all uniformed Service Members. TRICARE relies on inter-service and civilian-military sharing of medical resources to improve accessibility of care and achieve efficiencies. A DOD program under the oversight of the Assistant Secretary of Defense for Health Affairs (ASD (HA)), it is managed by the military in partnership with civilian contractors. Each TRICARE region has an Army, Navy, or Air Force lead agent (usually the commander of a Military Treatment Facility (MTF) or Regional Health Command (RHC)) responsible for the program. Details for each TRICARE program is available at <https://www.tricare.mil>.

### **17-7. Army Medical Department Support to Commanders**

a. Commanders are responsible for the health and physical fitness of their Soldiers. The AMEDD supports commanders by acting as the proponent for medical doctrine, advising commanders in all health related matters, and executing command policy in the area of the AHS. The AMEDD:

(1) Advises the command of measures to assure the health, fitness, and vigor of all members of the Army.

(2) As directed, acts as the proponent to provide those measures needed to assure health and fitness.

(3) Develops, trains, and maintains forces necessary for medical FHP to the Army in an OE.

(4) Conducts routine Medical Surveillance to identify leading injury and disease trends affecting Soldier's readiness and health.

(5) Conducts field investigations of outbreaks of potential health threats from disease, environmental hazards and injuries.

b. The importance of the AHS in the OE is paramount. It supports the prevention of disease and non-battle injury to ensure maximum operational capability. When casualties occur, the medical system provides rapid initial treatment, stabilization and evacuation to medical treatment facilities.

### **17-8. Army Medical Department Support to Emergency Management and Installation Commanders**

a. AMEDD supports the National Preparedness Goal (NPG) to achieve "a secure and resilient nation with the capabilities required across the whole community to prevent, protect against, mitigate, respond to, and recover from the threats and hazards that pose the greatest risk" (National Preparedness Goal September 2011). TSG / MEDCOM provides overarching policy on the medical and human health aspects of Army installation activities and operations associated with the Army Installation Preparedness (IP) and Emergency Management Program (EMP), including consideration of potential and residual all-hazards contamination. TSG is responsible for ensuring all medical headquarters develop applicable Emergency Management plans that are compliant and interoperable with the National Incident Management System (NIMS) and Joint Commission, when applicable.

b. MEDCOM provides integrated and comprehensive Emergency Management Health Service Support to protect beneficiaries and mission capabilities from all hazards in an implementable and sustainable manner to support the Army EMP.

c. All governing documents and operations plans (OPLAN) support rapid deployment and seamless employment of AMEDD assets and resources in coordination with (ICW) Presidential-, DOD-, HQDA-, TSG / MEDCOM-, installation- (including joint bases, where a sister service is the lead agency), and interagency (IA) partner issuances and directives that established policy, assigned responsibilities, and prescribed procedures for developing, implementing, and sustaining IPs, APPs, EMPs, IEMPs, and IAEMPs (e.g., federal, state, local, tribal jurisdiction, territorial government, private and nonprofit sectors,

and the public). They are compatible with and capable of supporting federally-mandated programs and processes such as the National Preparedness Guidelines, National Preparedness System, National Response Framework, NIMS, National Disaster Medical System, Incident Command System (ICS), and Hospital ICS; and all contingency plans (CONPLAN) for specified operations, any other national plans (approved by the President of the U.S. (POTUS) or Secretary of Defense (SECDEF), or DOD-issuances governing Defense Support of Civil Authority (DSCA) operations contributing to achieving and maintaining the NPG).

d. Emergency Management OPLANs address a series of integrated planning frameworks that will be used to govern shaping, mitigation, preparedness, response, and recovery; build upon scalable, flexible, and adaptable coordinating structures to align key roles and responsibilities; and be coordinated using a common terminology and approach. Coordinating activities address detailed concepts of operations, a description of critical tasks and responsibilities, detailed requirements (e.g. personnel, equipment, and training), and specific provisions for rapid integration. Plans identify resource guidance, such as arrangements enabling the ability to share personnel, equipment guidance aimed at nationwide interoperability, and guidance for national training and exercise programs.

### Section III The Army Health System

#### 17-9. Key Elements

a. TSG / OTSG. TSG is responsible for development, doctrine, policy direction, organization, and overall management of an integrated AHS; is the medical materiel developer for the Army; and is the Secretary of the Army's (SECARMY) representative for diverse DOD joint medical training, research and health services executive agencies. OTSG is the ARSTAF element that develops doctrine, policy and regulations for the AHS, health hazards assessment, the establishment of health standards, and medical materiel. TSG also has proponentcy for personnel management within the AMEDD.

b. Health Services. Health services are all services performed, provided, or arranged for (regardless of location) which promote, improve, conserve, or restore the physical or behavioral health of individuals or groups, and those services which contribute to the maintenance or restoration of a healthy environment. Health services include, but are not limited to: preventive, curative, and restorative health measures; medical doctrine; medical aspects of CBRNE defense; health promotion and injury prevention; assessment of health threats and countermeasures; medical operations planning; medical intelligence; health professional education and training; health-related research; transportation of the sick and wounded; selection of the medically fit and disposition of the medically unfit; administration; medical logistics; medical equipment maintenance; medical facility life cycle management; and the delivery of medical, nursing, dental, veterinary, laboratory, optical, and other specialized services.

c. Programming and Budgeting. Since 1991, military funding was secured through the DOD Unified Medical Program and the Defense Health Program (DHP) Appropriation, rather than the services' budgets. The ASD (HA) issues policy guidance and TRICARE manages and monitors service execution of the DHP Appropriation and the DOD Unified Medical Program. The DHP appropriation consists of: operation and maintenance; research, development, test, and evaluation; and procurement funds designed to finance the non-military personnel requirements of the MHS. In FY 2003, the Department implemented the DOD Medicare Eligible Retiree Healthcare Fund, an accrual-type fund to pay for healthcare provided to Medicare eligible retirees, retiree family members, and survivors.

(1) The OTSG / MEDCOM Staff (see "One Staff," below) programs and funds manpower using both the DHP and Army appropriations. DHP funds provide for most peacetime healthcare operations in TDA units such as Army MEDCENs and community hospitals and for TRICARE Managed Care Support Contracts. The vast majority of AMEDD manpower is funded by the DHP. Army funding supports deployable medical TOE units and medical readiness missions.

(2) The OTSG / MEDCOM Staff programs for Army funds and provides its input to the Army's Program Objective Memorandum (POM). It programs for DHP funds and provides input to the DHP POM through TRICARE. Military personnel costs are programmed by TRICARE in the DHP POM and the programmed total obligation authority (TOA) transfers to the MPA appropriation when the budget estimate submission (BES) is prepared. Civilian personnel costs are reimbursable from DHP Operations and Maintenance

Defense funds during the year of execution. Authorizations for both military and civilian personnel are on Army manpower documents.

### 17-10. Staff Relationships and Responsibilities

a. Office of the ASD (HA) has statutory responsibility for overall supervision of health affairs within DOD and is the principal staff assistant and adviser to SECDEF for all DOD health policies, programs, and activities.

(1) TRICARE Management Activity (TMA). TRICARE is a DOD field activity of the Under Secretary of Defense for Personnel and Readiness (USD (P&R)) that operates under the authority, control, and direction of the ASD (HA). The mission of TRICARE is to administer and manage TRICARE and administer, manage, and monitor service execution of the DHP appropriation and the DOD Unified Medical Program.

(2) TRICARE regional offices coordinate healthcare within the various geographic health service regions. Each region has a contractor that administers and helps coordinate the healthcare services available through health readiness platforms and a network of civilian hospitals and providers. Each TRICARE regional office—

- (a) Provides oversight of regional operations and health plan administration at the regional level.
- (b) Manages the contracts with regional contractors.
- (c) Supports MTF Commanders.
- (d) Develops business plans for non-MTF areas (e.g. remote areas).
- (e) Funds regional initiatives to optimize and improve delivery of healthcare.

b. OTSG has the following ARSTAF responsibilities—

(1) Assisting the SECARMY and the CSA in discharging Title 10 responsibility for health services for the Army and other agencies and organizations entitled to military health services.

(2) Developing doctrine, policy, and regulations for the AHS, health hazards assessment, the establishment of health standards, and medical materiel.

(3) Representing the Army to the executive branch, Congress, DOD agencies, and other organizations on all health policies affecting the Army.

(4) DOD focal point for North Atlantic Treaty Organization (NATO) Medical Chemical, Biological, Radiological, and Nuclear (CBRN) actions. Provides U.S. Head of Delegation for the NATO CBRN Medical Working Group and General Medical Working Group.

(5) Managing all aspects of medical CBRNE defense programs.

(6) Advising and assisting the SECARMY and CSA and other principal officials on all policy issues pertaining to health and military health service support to include—

- (a) Policies and regulations concerning the health aspects of Army environmental programs.
- (b) Health professional education and training for the Army, to include training programs for all medical, nursing, dental, and veterinary specialty areas.
- (c) Research and development activities for nutrition and wholesomeness in support of DOD Food Service.
- (d) Medical materiel life-cycle management.
- (e) Medical materiel in the Army War Reserves Program.
- (f) Medical materiel concepts, requirements, validity and viability.
- (g) Technical review and evaluation of medical and nonmedical materiel to determine the existence of possible health hazards.
- (h) Program management for Army healthcare automation.
- (i) Electronic health records.
- (j) Army execution of the Defense Medical Systems Support Center (DMSSC).
- (k) Medical aspects of the Security Assistance Program.
- (l) Program sponsor for Operations and Maintenance, Army - Program 84 (Medical).
- (m) Executive Agent (EA) of the SECARMY for all DOD veterinary services.
- (n) Medical facility life cycle management.
- (o) Field medical support concepts, doctrine, training and leader development programs and user test.
- (p) Medical intelligence training.
- (q) Medical mobilization training.

**Section IV  
Command and Management**

**17-11. Army Medical Department Organization**

a. In 1998, TSG directed the implementation of the One Staff concept, consolidating the staffs at OTSG and Headquarters, MEDCOM, Fort Sam Houston, Texas. Personnel at both locations now function as a single staff with one set of leaders who coordinate ARSTAF functions, along with Army command functions (see Fig 17-1). In 2011, TSG directed a Bottom Up Review (BUR) which resulted in an increase in AMEDD General Officer presence in the National Capital Region (NCR); reduction in key leader span of control; better alignment of OTSG / MEDCOM headquarters staff with HQDA staff; and transforming HQ MEDCOM to an Operating Company Model aimed at decreasing variance across staff and standardizing headquarters processes. Additionally, in 2015 MEDCOM initiated the MEDCOM Transformational Concept aimed at better integration of medical, dental, public health and Warrior care within HQ MEDCOM, while elevating patient safety and quality of care to the forefront within the One Staff. The MEDCOM Transformational Concept resulted in merging the following MSC HQs into the HQ MEDCOM One Staff: Public Health Command (PHC) became the HQ MEDCOM Deputy Chief of Staff (DCS) for Public Health; WTC became the HQ MEDCOM DCS for Warrior Care Transition; and DENCOM became the HQ MEDCOM DCS G-3/5/7 Dental Directorate. All subordinate O-6 (COL) Public Health Command Regions (PHCR) and Regional Dental Commands (RDC) were renamed Public Health Commands (PHC) and Dental Commands (DENCOM), respectively. These organizations were then realigned under each Regional Health Command (RHC).

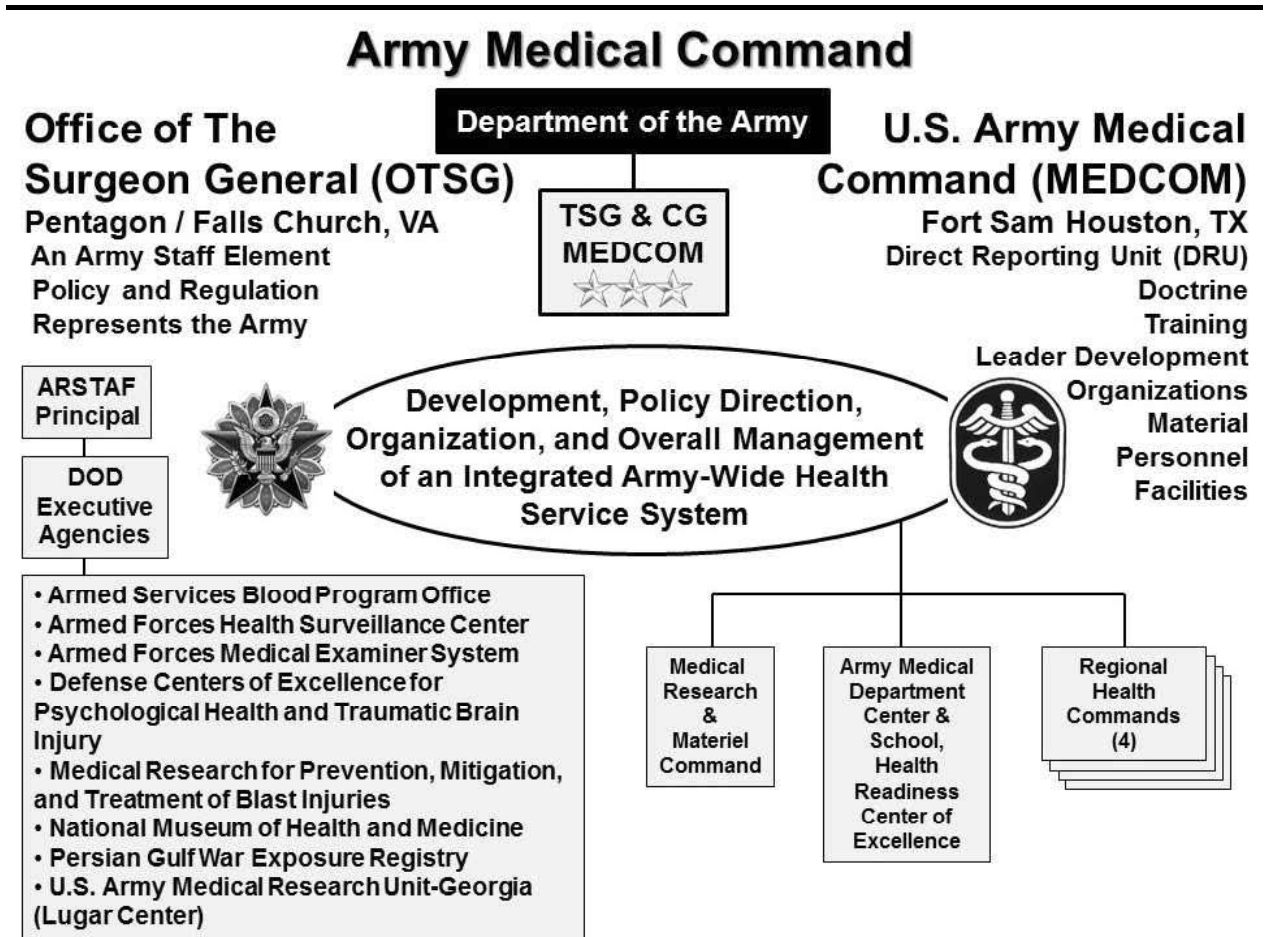

Figure 17-1. Army Medical Command

b. The consolidation of worldwide medical assets under the MEDCOM in 1996 greatly enhanced command and control efficiency to meet the needs of the Army of the 21st Century. Implementation of the One Staff concept to achieve the most efficient and effective MC structure underscored the AMEDD's commitment to continuous quality improvement and poised the AMEDD for its role in the Army Transformation.

c. The One Staff is responsible for AMEDD policy, planning, and operations worldwide, with a focus on strategic planning. Its mission is to:

- (1) Provide the vision, direction, and long-range planning for the AMEDD;
- (2) Develop and integrate doctrine, training, leader development, organization, materiel, and Soldier support for the AHS;
- (3) Allocate resources, analyze health services utilization, and conduct assessments of performance worldwide;
- (4) Coordinate and manage graduate medical education programs at the Army MEDCENS; and
- (5) MEDCOM is designated by the Chairman, Joint Chiefs of Staff (CJCS) as the Theater Lead Agent for Medical Materiel (TLAMM) to NORTHCOM.

**17-12. United States Army Medical Command**

a. MEDCOM represents the Generating Force (GF) elements of the AMEDD. As part of the previously mentioned 2015 MEDCOM Transformational Concept, MEDCOM initiated an overarching reorganization of HQ MEDCOM and its' assigned Major Subordinate Commands (MSC). Figure 17-2 depicts MEDCOM's current state with subordinate headquarters elements of DENCOM, PHC, and WTC as principal staff elements within the MEDCOM headquarters to improve the integration, synchronization, and oversight of health readiness at the strategic level.

**MEDCOM Current State**

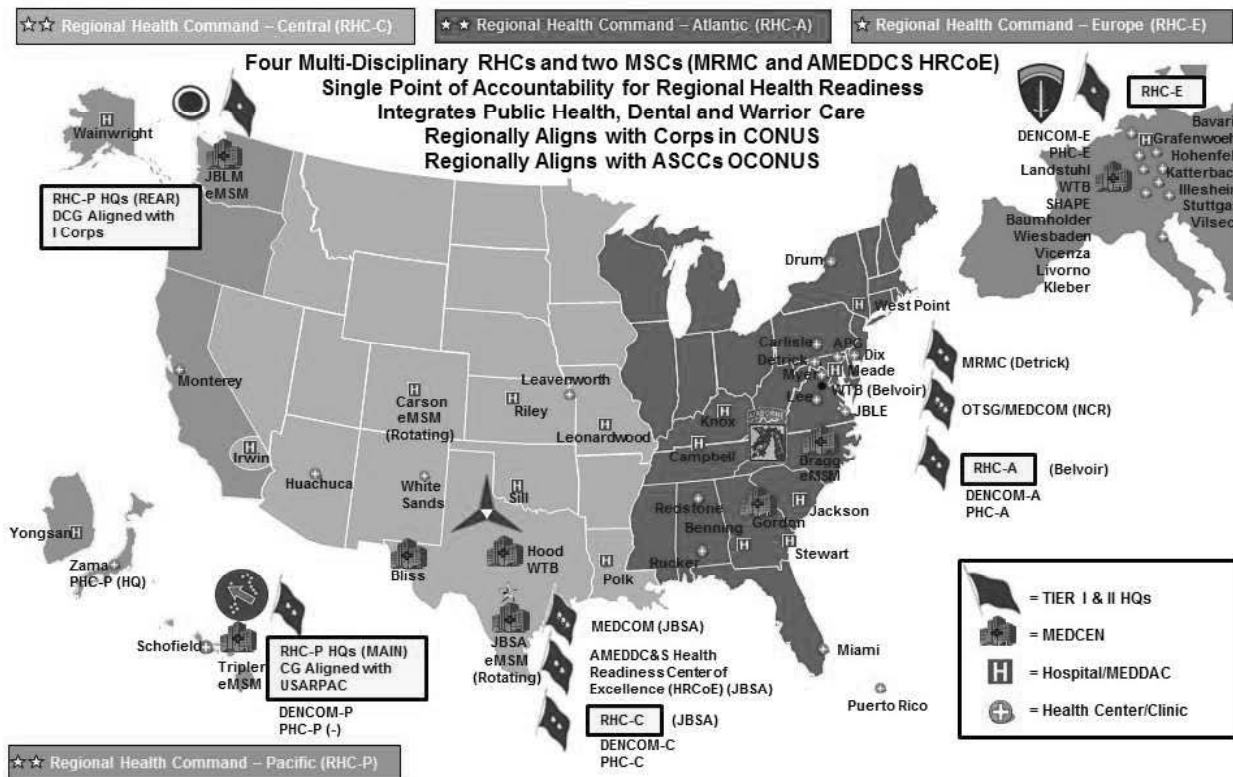

**Figure 17-2. United States Medical Command Current Structure**



b. Additionally, MEDCOM has the following MSCs—

- (1) Regional Health Command-Europe (RHC-E).
- (2) Regional Health Command-Central (RHC-C).
- (3) Regional Health Command-Atlantic (RHC-A).
- (4) Regional Health Command-Pacific (RHC-P).
- (5) U.S. Army Medical Research and Materiel Command (USAMRMC).
- (6) AMEDDC&S, Army Health Readiness Center of Excellence (HRCoE).

c. RHCs oversee day-to-day operations of the health readiness platforms, PHCs and DENCOMs within their regions. Aligned Public Health and Dental assets under the MC of RHCs, are the single point of accountability for health readiness to CONUS Army Corps and OCONUS ASCCs.

### 17-13. Regional Health Commands

a. RHCs are the key operational element for the delivery of healthcare services for geographical regions within MEDCOM. RHCs are MSCs operating under the supervision of the commander. Mission responsibilities include:

(1) Regional MC of an affordable, multidisciplinary, customer-focused, quality military health service system;

(2) Supporting the health readiness requirement of the Army;

(3) Developing and sustaining technical healthcare and leader skills in support of MEDCOM readiness goals; and

(4) Allocating resources, analyzing utilization, and assessing performance across the RMC.

b. As the primary integrator of health readiness, the RHC is responsible for:

(1) Daily utilization of Table of Organization and Equipment / Table of Distribution and Allowances (TOE / TDA) medical assets, integrating active and reserve training, and development of mobilization requirements;

(2) Budgeting, defending, and allocating readiness costs and funding;

(3) Preplanning health readiness platform professional backfill requirements during deployment by expanding network coverage, shifting RHC assets, and coordinating RC coverage;

(4) Ensuring that Army health readiness requirements are fully integrated into the activities of DOD healthcare regions;

(5) Conducting training exercises in health readiness platform mobilization, professional backfill activities, and deployment actions;

(6) Providing medical planning and preparation programs for worldwide contingency operations;

(7) Sponsoring readiness-based clinical research;

(8) Providing responsive and reliable oral health services, which include:

(a) Serving as the proponent for meeting the dental health needs of the Army and eligible beneficiaries; and

(b) Providing MC of RDCs, Dental Activities (DENTAC), Dental Clinic Commands, and Dental Treatment Facilities worldwide; and

(9) Promoting health and preventing disease, injury, and disability of Soldiers and retirees, their families, and Department of the Army civilian (DAC) employees; and assuring effective execution of full spectrum veterinary services for Army and DOD Veterinary missions.

### 17-14. United States Army Medical Research and Materiel Command

a. The U.S. Army Medical Research and Materiel Command (USAMRMC) is the Army's medical materiel developer, with responsibility for medical research, development, and acquisition and medical logistics management. The Command is headquartered at Fort Detrick, MD, with 12 subordinate commands located throughout the world.

b. Six medical research laboratory commands execute the science and technology program to investigate medical solutions focusing on various areas of biomedical research, including military infectious diseases, combat casualty care, military operational medicine, medical chemical and biological defense, and clinical and rehabilitative medicine. The Command manages a large extramural research program with numerous contracts, grants, and cooperative research and development agreements to provide additional science and technology capabilities from leading academic, private industry, and other government organizations.

c. Six additional commands focus on medical materiel advanced development, strategic and operational medical logistics, and medical research and development contracting, to complete the full life cycle of medical materiel acquisition.

### **17-15. United States Army Medical Department Center and School, Army Health Readiness Center of Excellence**

a. General. The AMEDDC&S HRCoE is an MSC of the MEDCOM. The AMEDDC&S HRCoE is a non-U.S. Army Training and Doctrine Command (TRADOC) CoE that follows HQDA capability development and integration and training regulations and policies.

b. Mission. Envision, design, train, educate and inspire the world's premier military medical force to enable readiness and strengthen America's Army.

c. Functions.

(1) Develops, integrates, coordinates, implements, evaluates, and sustains training/training products for Active and Reserve medical forces worldwide IAW AR 350-1, Army Training and Leader Development.

(2) Develops, integrates, analyzes, tests, validates, and evaluates concepts, emerging doctrine medical systems, and doctrine and training literature.

(3) Conduct all AMEDD officer, enlisted and civilian proponent functions, personnel inventories and life-cycle management of career fields.

(4) Develops concepts, systems, and forces structure for combat health services support.

(5) As the integration center for doctrine and training requirements, systematically develops courses, training devices, manuals and sustainment materials for readiness.

(6) Provides training, education, and evaluation of AMEDD personnel.

(7) Tests and evaluates new and replacement items of medical equipment.

(8) Serves as proponent for Force Health Protection (FHP) in theaters of operation.

(9) Conducts healthcare studies to improve the efficiency and effectiveness of the AMEDD.

(10) Provides statistical and analytical consultation to the AMEDD, with secondary support to subordinate organizations within the MEDCOM; provides decision support expertise to AMEDD senior leadership; promotes data quality, integrity, and standardization across the AMEDD.

(11) Maintain evaluation and quality assurance program. Conduct efficient and effective internal and external evaluations/quality assurance program to improve training; sustain readiness level and control or reduce cost.

(12) Facilitate successful development and fielding of AMEDD and other supporting information management/information technology (IM/IT) systems.

(13) Execute applicable force design updates in support of Army transformation.

(14) Serve as AMEDD agent for management of military individual education through Army training requirements and resources system (ATRRS) in accordance with AR 350-1.

### **17-16. Army Medical Department Role in Sustainment Units**

a. In addition to its fixed MTFs, the Army maintains medical units with a sustainment mission within all deployable commands. These medical units work in concert with logistics and personnel units to form the sustainment core for Army forces. The deployable medical assets consist of TOE units in both the Active Component (AC) and RC. CONUS AC medical units are assigned to United States Forces Command (FORSCOM). Outside the Continental United States (OCONUS) medical units are assigned to the ASCC. Deployable medical units range in size, scope of mission, and capacity from medical detachments to theater hospitals. Collectively, they establish an integrated continuum of medical evacuation and treatment from point of injury on the battlefield, to the echelons above corps (EAC), and eventually to specialized treatment in CONUS.

b. In the event of mobilization, AMEDD RC medical units will often be among the earliest deploying forces. With approximately 68 percent of the medical force in the RC, the AMEDD truly exemplifies the Army. Well-trained and combat ready RC medical units are absolutely essential for ensuring that the FHP missions of the Army are accomplished during periods of mobilization. Under the Professional Filler Information System (PROFIS)-qualified Active Army personnel serving in TDA units are designated to fill USFORSCOM deploying Modified Table of Organization and Equipment (MTOE) units, U.S. Army Pacific (USARPAC), U.S. Army Europe (USAREUR), and Eighth U.S. Army (EUSA) forward deployed units upon execution of an approved Joint Chiefs of Staff (JCS) OPLAN or upon execution of a contingency

operation (CONOP). Individuals pre-designated from fixed Army healthcare facilities will provide a large portion of the professional personnel to units deploying to and already stationed in the operational area.

c. A key operational enabler is the Medical Communications for Combat Casualty Care (MC4). MC4 integrates a medical information management system for Army tactical medical forces, enabling a comprehensive, lifelong electronic medical record for all service members, and enhancing medical situational awareness for operational commanders. MC4 integrates Theater Medical Information Program (TMIP); the Battlefield Medical Information-Theater (BMIS-T); Armed Forces Healthcare Longitudinal Application (AHLTA); the U.S. Transportation Command (TRANSCOM) Regulating and Command and Control Evacuation System (TRAC2ES); the Defense Medical Logistics Standard Support (DMLSS); and the Defense Medical Surveillance System (DMSS). MC4 integrates the global medical network with a fully integrated operational architecture and a Global Information Grid (GIG) infrastructure. MC4 will enable commanders to effectively synchronize medical care on any battlefield, worldwide.

### 17-17. Staff Surgeons

The senior AMEDD officer present for duty with a headquarters (other than medical) will be officially titled:

- a. The “Command Surgeon” of the ACOM and ASCC.
- b. The “Surgeon” of the field command (e.g., corps, CONUSA).
- c. The “Director of Health Services (DHS)” at the installation level.
- d. The surgeon and DHS are responsible for the staff supervision of all health matters and policies, except dental and veterinary matters. The DHS and the Director of Dental Services (DDS) will serve on the installation commander’s staff. Normally, the commander of the MEDCEN or medical department activity (MEDDAC) is the DHS, and the commander of the Army dental activity (DENTAC) is the DDS.

### 17-18. Health Service Logistics

a. Health service logistics is integral to the AHS and is managed by the AMEDD as a core functional area of MHS. This gives the command surgeon the ability to influence and control the resources needed to save lives. TSG establishes medical logistics policies and procedures within the framework of the overall Army logistics system. Health service logistics includes the management, storage, and distribution of medical materiel (to include medical gases), blood and blood products, optical fabrication, medical material war reserves, and medical equipment maintenance which are inherent to the provision of healthcare. The medical commodity (Class VIII) has characteristics that make it distinctly different from other classes of supply. Medical materiel includes pharmaceuticals, narcotics, and blood products that are potency and shelf life (dated) that require special handling and security. Most items are subject to the regulations and standards of external agencies such as the Food and Drug Administration (FDA), the Environmental Protection Agency (EPA), the Drug Enforcement Agency (DEA), and The Joint Commission (JTC). Medical logisticians have extensive knowledge of those requirements as they relate to health service support.

b. The Single Integrated Medical Logistics Manager (SIMLM) mission designates a single organization or ASCC to manage and provide health service logistics support to joint forces operating in the theater. Blood is the only medical material not directly under control of the SIMLM. Blood supplies are coordinated and managed by the Joint Blood Program Officer in each of the CCMDs.

c. The Theater Lead Agent for Medical Materiel (TLAMM) provides a single theater medical materiel distribution and supply chain management, providing the intensive management required for the medical commodity in close concert with FHP operations and industry partners at the national level.

d. MEDCOM established Medical Equipment Reset operations for medical equipment and sets for re-deploying units and Theater Provided Equipment (TPE)-Medical. Redeploying units conduct field-level Reset operations at home station in coordination with the RMCs and their Installation Medical Supply Activities. Sustainment Reset (Depot Level) activities occur at one of three depot locations: Hill Air Force Base (AFB), Utah; Tracy Army Depot, California; and Tobyhanna Army Depot, Pennsylvania. TPE-Medical Reset is provided to units in theater in order to reduce equipping requirements for deploying units and to maintain continuity of care in support of operations. High utilization and harsh conditions result in increased maintenance requirements and accelerated wear-out rates. TPE-Medical is owned by theater and life-cycle managed by theater stakeholders in partnership with MEDCOM.

e. Army Medical Logistics Enterprise (AMLE). In 2009, TSG established the AMLE comprised of generating and operating Medical Logistics (MEDLOG) organizations that work within a collaborative and

networked framework to meet the medical logistics needs of the AHS in delivering medical support to the Army and/or JFC.

### **17-19. Secretary of the Army's Executive Agent Representative for Department of Defense Executive Agencies**

a. Executive Agent (EA) representative. An EA is the Head of a DOD Component (e.g., SECARMY) to whom the SECDEF or the Deputy SECDEF (DEPSECDEF) has assigned specific responsibilities, functions, and authorities to provide defined levels of support for operational missions, or administrative or other designated activities that involve two or more of the DOD Components. The DOD EA may delegate, to a subordinate designee within that official's Component (e.g., TSG), the authority to act on that official's behalf for any or all of those EA, functions, and authorities assigned by the SECDEF or the DEPSECDEF. TSG is responsible for the following EAs:

- (1) Armed Services Blood Program Office.
- (2) Defense Centers of Excellence for Psychological Health and Traumatic Brain Injury.
- (3) Medical Research for Prevention, Mitigation, and Treatment of Blast Injuries.
- (4) Persian Gulf War Exposure Registry.
- (5) U.S. Army Medical Research Unit-Georgia (Lugar Center).

b. In addition to the DOD EAs embedded in AMEDD MSCs, TSG serves as the Lead Component (LC) or Support Agent representative for other essential joint medical agencies, to include:

- (1) Extremity Trauma & Amputee Center of Excellence.
- (2) Investigational New Drugs-Force Health Protection.
- (3) Joint Trauma System Center of Excellence.
- (4) Accession Medical Standards Analysis and Research Activity.
- (5) Armed Forces Pest Management Board.
- (6) Civilian Employee Occupational Health and Medical Services Program.
- (7) Combat Dental Research.
- (8) Defense Medical Virtual Library.
- (9) DiLorenzo TRICARE Health Clinic.
- (10) DOD Nutrition Research Program.
- (11) DOD/VA Clinical Practice Guidelines Development.
- (12) DOD Pharmacoeconomic Center.
- (13) Gulf War Illness Research Program.
- (14) MEPCOM-Medical.
- (15) Military Infectious Disease Research Program.
- (16) Multi-Drug Resistance Organism and Repository Surveillance Network.
- (17) Nutrition Standards and Education Program.
- (18) Peer Review Medical Research Program.

## **Section V**

### **Summary and References**

#### **17-20. Summary**

This chapter has discussed the mission, organization, functions, and staff relationships of the AMEDD. The AHS encompasses all roles and/or levels of medical, dental, veterinary, and other related from the policy and decision-making level to the combat medic in the field. Health services within the Army are directed and monitored by TSG through MEDCOM and the OTSG. TRICARE has markedly altered the peacetime military health system and continues to evolve to ensure the provision of world class healthcare to all beneficiaries. After 12 years of sustained conflict the AHS continues to transform in order to meet the needs of the Army and the nation.

#### **17-21. References**

- a. Army Doctrine Publication (ADP) 3-37, Protection.
- b. ADP 3-0, Unified Land Operations.
- c. ADP 4-0, Sustainment.

- d. Army Doctrine Reference Publication (ADRP) 3-0, Unified Land Operations.
- e. ADRP 3-37, Protection.
- f. ADRP 4-0, Sustainment.
- g. Army Medicine Campaign Plan 2017, dated 3 Nov 2016.
- h. Army Regulation (AR) 10-87, Organization and Functions Army Commands, Army Service Component Commands, and Direct Reporting Units, 11 December 2017.
- i. AR 40-1, Composition, Mission, and Functions of the Army Medical Department.
- j. AR 40-4, Army Medical Department Facilities/Activities.
- k. AR 40-61, Medical Logistics Policies.
- l. Army Tactics, Techniques, and Procedures 4-02, Army Health System.
- m. Call to Action: 43<sup>rd</sup> Surgeon General, United States Army, 2012.
- n. DOD Directive (DODD) 5101.1 DOD Executive Agencies.
- o. DODD 5136.1, (ASD (HA)).
- p. MEDCOM Memorandum 10-2, Organizations and Functions, Headquarters.
- q. MEDCOM/OTSG Regulation 10-32.
- r. MEDCOM Regulation 10-1, Organization and Functions Policy.
- s. U.S. Army Medical Department Website, [www.armymedicine.mil](http://www.armymedicine.mil).
- t. FM 4-02, Army Health, dated 26 Aug 2013.

**This page is intentionally left blank**

## Chapter 18

### Civil Functions of the Department of the Army

#### Section I

#### Introduction

##### 18-1. Chapter Content

In addition to its military mission, the Department of the Army carries out an extensive program in support of the United States' economic development and environmental stewardship. This concept goes back to President Thomas Jefferson, who envisioned a force capable of conducting missions "of a civil nature" as well as military activities. In that spirit he founded the U.S. Military Academy at West Point, with an engineering curriculum emphasis that continues to this day. The largest of the civilian-oriented missions is the Civil Works Program is carried out by the U.S. Army Corps of Engineers under the oversight of the Assistant Secretary of the Army (Civil Works). This program largely revolves around water resources, dating from the Army's earliest involvement in navigation improvement in 1824. Over the years, as the Army's expertise grew, Administrations and Congresses assigned other water-related missions - flood risk management, water supply, hydropower, recreation, aquatic ecosystem restoration, emergency management and more. Today Civil Works is a \$6 billion a year program, funded outside the Defense appropriation. This program provides a more than 16-to-1 return on investment, delivering to the Nation \$110 billion a year in benefits in the form of flood damages prevented, transportation through ports and inland waterways, low-priced and nonpolluting hydropower, recreational opportunities, water supply for cities and farms, etc. This chapter will describe civil functions definitions, authorizations, relationships, leaders, organizations, activities, research and development (R&D), support to other government agencies, overseas activities, and support to combatant commanders.

##### 18-2. Civil Functions Defined

A number of activities traditionally carried out by the Department of the Army (DA) are commonly referred to as civil functions. The most extensive of these is the Civil Works Program managed by the U.S. Army Corps of Engineers (USACE, or "the Corps"). The Civil Works Program focuses on responsible development, protection, and restoration of the Nation's water and related land resources. Civil Works projects are implemented and operated for commercial navigation, flood risk management, environmental restoration, hydroelectric power, recreation, and municipal and industrial water supply. Infrastructure built by the Corps over the years in support of the Civil Works mission has an estimated value today of about \$250 billion. Civil functions also include programs to regulate, by permit, dredging, construction, fill material discharge and similar activities in navigable waters of the United States, including many wetlands; preparedness activities for all types of natural disasters, and response and recovery activities; and engineering and construction support to non-defense-related activities of the federal government, state and local agencies and USACE overseas activities not exclusively in support of U.S. forces overseas.

##### 18-3. Leadership and Organization

a. *The Assistant Secretary of the Army (Civil Works)*. Through specific statutory provisions, General Orders from the Secretary of the Army (SECARMY), and internal DA regulation, the ASA(CW) has been assigned responsibilities for the civil functions. Congress established the position of the ASA(CW) in Section 211 of the Flood Control Act of 1970, Public Law (PL) 91-611, and reaffirmed it in Section 501 of the Goldwater-Nichols Department of Defense Reorganization Act of 1986, PL 99-433. The Goldwater-

## HOW THE ARMY RUNS

Nichols Act specifies that the Assistant Secretary's duties include overall supervision of DA programs for conservation and development of water resources, including flood risk management, navigation, environmental restoration and stewardship, and related purposes. The ASA(CW) reports directly to the SECARMY.

b. *United States Army Corps of Engineers.* USACE executes most of the Army's civil functions as an executive branch agency within DOD and a Major Command within the Army consisting of more than 800 military and 33,000 civilians. USACE is the world's largest public engineering, design, and construction management agency. USACE also provides real estate services; conducts research & development; and designs and builds military facilities for the Army, Air Force, other federal agencies, and foreign governments. Approximately 280 military personnel and 22,100 civilian employees in USACE are involved in civil functions.

c. *The Chief of Engineers.* The Chief of Engineers holds positions as both a principal Headquarters, Department of the Army (HQDA) Staff officer and as commander of the USACE. The Chief of Engineers, the Corps' Deputy Commanding General for Civil and Emergency Operations (DCG-CEO) and the civilian Director of Civil Works report to the ASA(CW) on the Civil Works Program.

d. *Divisions and Districts.* Under the Chief's command are nine divisions, eight of which have Civil Works missions. Under the divisions are 43 districts, 38 of which are within the United States. Division and district boundaries for the Civil Works Program within the Continental U.S. (CONUS) generally follow watersheds and drainage basins, as shown in Figure 18-1. These delineations reflect the water resources mission of USACE. Military Construction (MILCON) districts, on the other hand, generally follow State boundaries, and not all stateside districts have a MILCON mission.

e. *Overseas Offices.* USACE also includes a number of overseas offices with missions in construction in support of U.S. forces, assistance to other countries and international organizations, and support to other U.S. agencies.

(1) The Pacific Ocean Division, headquartered in Honolulu, HI, includes subordinate districts in Japan and Korea as well as Hawaii and Alaska.

(2) The North Atlantic Division includes the Europe District as well as five stateside districts.

(3) In October 2009, USACE stood up the Transatlantic Division, with headquarters in Winchester, VA, one subordinate district in Afghanistan, and one responsible for USACE activities elsewhere in the Middle East and Africa. A third contingency district was added in Baghdad in 2017 to support the US and international efforts against ISIS during Operation Inherent Resolve (OIR).

(4) Mobile District's mission also includes support of U.S. Southern Command (USSOUTHCOM).

f. *Other United States Army Corps of Engineers Organizations.* There are several other organizations within the Corps of Engineers:

(1) The U.S. Army Engineer Research and Development Center (ERDC), headquartered in Vicksburg, MS, consists of seven laboratories. (See Paragraph 18-8.)

(2) The U.S. Army Engineering and Support Center, Huntsville, AL, provides engineering and technical services, program and project management, construction management, and innovative contracting initiatives for programs that are national or broad in scope or not normally provided by other Corps of Engineers elements. Huntsville is also USACE's major training center.

(3) The Institute for Water Resources, headquartered at Fort Belvoir, VA, supports the Civil Works Directorate and Corps of Engineers commands by developing and applying new planning evaluation methods, polices and data in anticipation of changing water resources management conditions. Subordinate to the Institute are the Hydrologic Engineering Center in Davis, CA; the Waterborne Commerce Statistics Center in New Orleans, LA; the Risk Management Center in Lakeland, CO; and, at Fort Belvoir, the International Center for Integrated Water Resources Management, the Navigation and Civil Works Decision Support Center, and the Conflict Resolution and Public Participation Center of Expertise. The Institute also provides support to the U.S. Section of the World Association for Waterborne Transport Infrastructure (PIANC-USA). PIANC USA works with members from 40 other nations to address policy, engineering and environmental issues for the advancement of waterborne transportation.



(4) The USACE Finance Center, Millington, TN, provides operating finance and accounting functions throughout the Corps of Engineers.

(5) The USACE Logistics Activity, Millington, TN, provides logistics support to the Corps including supply, maintenance, readiness, materiel, transportation, travel, aviation, facility management, integrated logistics support, management controls, and strategic planning.



Figure 18-1. Where We Are: U.S. Army Corps of Engineers

(6) The Marine Design Center, Philadelphia, PA, provides planning, engineering, and shipbuilding contract management in support of Corps, Army, and national water resource projects in peacetime, and augments the military construction capacity in time of national emergency or mobilization.

(7) Humphreys Engineer Center Support Activity, Fort Belvoir, VA, provides administrative and operational support for USACE Headquarters and various field offices.

(8) USACE's Deployable Tactical Operations System (DTOS) provides mobile mission command platforms in support of the quick ramp-up of initial emergency response missions for the Corps. DTOS is a system designed to respond to district, division, national, and international events.

(9) The 249th Engineer Battalion (Prime Power) generates and distributes prime electrical power in support of warfighting, disaster relief, stability and support operations as well as advice and technical assistance in all aspects of electrical power and distribution systems. It also maintains Army power generation and distribution war reserves.

(10) The 911th Engineer Company provides specialized technical search and rescue support for the Washington, DC metropolitan area. It is also a vital support member of the Joint Force Headquarters National Capital Region, which is charged with the homeland security of the United States Capital Region.

### **18-4. Relationship to Warfighting Competencies**

The civil functions complement and augment the Army's warfighting competencies, providing the capability to respond to a variety of situations across the spectrum of conflict by maintaining a trained and ready engineer force at virtually no additional expense to the Department of Defense (DOD) military budget and at minimum expense to personnel allocations. More than 10,000 Corps of Engineers employees in jobs funded by the Civil Works program have deployed for short tours in Iraq, Afghanistan, and other overseas areas. For example USACE maintained a Contingency Engineer Response Team (CERT) to augment the CFLCC-I staff with engineering design, environmental, and construction quality assurance for local contract and LOGCAP construction in Iraq. This expertise was provided from divisions and districts throughout USACE. Expertise resident in the Civil Works program is also made available through USACE's "Reachback" programs, which link Combatant Commanders (CCDR) with subject matter experts within the government, private industry, and academia to obtain engineering solutions to complex problems.

### **18-5 Private Sector Capabilities and Partnerships**

The partnership between the USACE and the private sector represents a force multiplier of several hundred thousand architects, engineers, and builders, ready to support the Nation in times of emergency. The private sector is an essential element of the Civil Works team. Private construction firms carry out practically all construction work, employing about 300,000 people at any time on Corps activities. The Corps also employs private architectural, engineering and construction firms for over half of its design work. In FY 2013, the USACE let about \$4.86 billion in contracts for Civil Works activities. Of this amount, \$1.77 billion (36.3%) went to small businesses, including \$676 million (13.8%) to small disadvantaged firms.

## **Section II Civil Works Program**

### **18-6. Authorization, Congressional Oversight, and Funding**

Although they differ from other Army programs in financing and oversight, the civil functions are an integral part of the overall mission of the Army and the service it provides to the Nation. Financial and personnel resources associated with the Civil Works Program are principally authorized under Water Resources Development Acts (WRDA's) and funded separately by annual Energy and Water Development Appropriations Acts, not the Defense appropriation. Program funding under these acts is generally \$5 to \$6 billion a year. These funds are used for studies of water resources problems in the Federal interest where Civil Works projects might be appropriate, design and construction of projects authorized and funded by Congress, operation and maintenance of completed projects, and funds for emergency management, regulatory activities in waters of the U.S., the Formerly Used Sites Remedial Action Program (FUSRAP) for former nuclear sites, and headquarters and division expenses. Additional funds may be provided through Supplemental Appropriation Acts. For example, Supplemental Appropriations for fiscal year (FY) 2017 provided \$1.025 billion for disaster relief and recovery activities. The WRDA of 1986 and subsequent WRDAs also require cost-sharing contributions from State and local

government project sponsors for most Civil Works activities; these contributions typically come to about \$500 million a year. USACE support activities for other, non-defense agencies are reimbursed by those agencies - to include emergency response activities funded by the Federal Emergency Management Agency (FEMA). Congressional committees like the Subcommittee on Water Resources and Environment of the House Transportation and Infrastructure Committee or the Subcommittee on Transportation and Infrastructure of the Senate Environment and Public Works Committee provide legislative oversight and authorizing legislation, while the Energy and Water Development Subcommittees of the House and Senate Appropriations Committees provide funding.

## **18-7. Civil Works Program Activities**

a. *The Program.* The Civil Works Program provides nationwide development and management of water and related land resources, including the planning, design, construction, rehabilitation, operation and maintenance of flood risk management, navigation, ecosystem and other environmental restoration, and multiple-purpose water resource projects. The Civil Works Planning function is the foundation of the overall program in the development and authorization of new water resources projects. In addition to the project purposes listed above, completed Corps projects may include hydroelectric power, water supply, recreation, and natural and cultural resource management. Collectively, they include approximately 12 million acres (18,800 square miles) of land and water. In addition to this direct federal investment program, the Civil Works Program includes an important regulatory mission in which the Corps regulates construction in navigable waters under the Rivers and Harbors Act of 1899. The Corps regulates the deposit of dredged and fill material in waters of the United States, including many wetlands, under the Clean Water Act of 1972. In addition, the Civil Works Program includes emergency flood fighting, recovery operations, and repair and restoration of flood control works -- all performed under the USACE's own authority as specified in PL 84-99. USACE also carries out DOD's responsibilities under the National Response Plan (NRP) as the lead planning and operating agent for public works and engineering (Emergency Support Function #3) (see Chapter 20), in support of the Federal Emergency Management Agency (FEMA) and other federal agencies.

### b. *Economic Infrastructure.*

(1) USACE has been the Nation's major contributor to the development, construction, and maintenance of a sound water resources infrastructure since its first navigation project was undertaken in 1824. Commercial navigation and flood risk management are long-standing missions of the Civil Works Program. The navigation function includes improvement and maintenance of harbors handling all of the Nation's seaborne commerce and that of the Great Lakes. With funds from the Harbor Maintenance Trust Fund, the Corps maintains navigability in 183 harbors handling more than 250,000 tons of cargo per year, and 884 smaller harbors. With more than 15 million American jobs dependent on U.S. import and export trade, the Nation's commercial ports are vital to the economic security of the United States. The Corps has built an intracoastal and inland commercial waterway network of 12,000 miles, and operates 239 lock chambers at 193 sites. Major improvements to inland waterway facilities are financed in part by the Inland Waterway Trust Fund. More than 600 million tons of commerce moves every year on these waterways – at half the cost per ton-mile of transportation by rail, and 1/10 the cost of transportation by truck. Maintaining the system of ports and inland waterways involves removing more than 185 million cubic yards of dredged material each year. Major segments of this network include:

- (a) The Lower Mississippi River (1,015 miles).
- (b) The Upper Mississippi River (936 miles).
- (c) The Ohio River (981 miles).
- (d) The Tennessee River (785 miles).
- (e) The Missouri River (735 miles).
- (f) The Arkansas and White Rivers (706 miles).
- (g) The Columbia-Snake River System (468 miles).
- (h) The South Atlantic Coast (1,111 miles).

- (i) The Gulf Intracoastal Waterway (GIWW)-West (Brownsville, TX to St. Marks, FL) (1,501 miles).
- (j) GIWW-East (Clearwater to Fort Myers, FL) (431 miles).

(2) USACE shares with the U.S. Department of Homeland Security's (DHS) Federal Emergency Management Authority (FEMA) both the expertise and mandate to address the nation's vulnerabilities to flood related disasters and damages. USACE has been involved in flood risk management activities, largely on the Ohio and Mississippi Rivers, since the 19th Century. This involvement was ramped up with the Mississippi River & Tributaries Flood Control Project in 1928, in the aftermath of widespread flooding in the Mississippi Basin the year before. The Flood Control Act of 1936 established a nationwide federal role in flood risk management, and since then the Corps' responsibilities have expanded to include structural and non structural solutions to managing flood risks, inspecting the condition of existing flood management infrastructure, technical and planning support to States and communities, advance emergency measures to alleviate impending flooding, and rehabilitating levees and other flood management infrastructure damaged by flooding. The Nation's investment in flood risk management has prevented almost nine dollars in flood damage reduction for each dollar invested, even after adjusting for inflation. In 2012, the USACE completed reconstruction of the New Orleans Hurricane and Storm Damage Risk Reduction System (HSDRRS) to the "100 year" level of protection (able to withstand a storm with a one percent chance of happening in a given year). HSDRRS was highly successful in preventing damage and loss of life during Hurricane Isaac in August 2012 - the \$14.7 billion spent to build system prevented about \$90 billion in damages - a 6:1 return on investment in the first year. Flood risk management efforts range from small, local protection projects to large lakes and dams. Since passage of the WRDA of 1986, most of these projects have been constructed as joint ventures between the federal government and non-federal sponsors. The Corps operates and maintains most of its dams, but most other projects, once built, including about 14,700 miles of levees in USACE's Levee Safety Program, are operated and maintained by local sponsors.

(3) The Corps can provide flood management assistance through a wide variety of authorities and programs. For example, through its Flood Plain Management Services Program (FPMS), the Corps can provide information, technical assistance and planning guidance (paid for by the federal government) to States and local communities to help them address flood risk management issues. Typical focus areas are flood hazard evaluation, dam break analysis, flood warning preparedness, flood plain management and much more. In cases where the risk of flooding is imminent in a specific area, the Corps is authorized to take immediate advance measures to protect life and property, such as temporary flow restriction structures and removing log debris blockages. The responsibility for managing the Nation's flood risks, however, does not lie exclusively with federal agencies such as the Corps and FEMA. Rather, it is shared across multiple federal, State, tribal and local government agencies with a complex set of programs and authorities, including private citizens and private enterprises such as banking and insurance firms and developers. Both the Corps and FEMA have programs to assist States and communities reduce flood damages and promote sound flood risk management; however, the authority to determine how land is used within floodplains and enforce flood-wise requirements is entirely the responsibility of State and local government. Floodplain management choices made by State and local officials can impact the maximum effectiveness of federal programs to mitigate flood risk and the performance of federal flood damage reduction. However, the federal investment is protected by the execution of agreements between federal and non-federal partners.

(4) In November 2007, the Corps established a Levee Safety Program, an important step to ensure the public is aware of the risks associated with levees in Corps programs. The mission is to assess the integrity and viability of levee systems and recommend actions to ensure these systems do not pose unacceptable risks. The main objectives are to hold public safety paramount, reduce adverse economic impacts, and develop reliable and accurate information. Within the program, a National Levee Database has been created to facilitate and link activities which include flood risk communication, levee certification, levee inspection, floodplain management, and risk assessments. The database presently includes levees within a Corps program or FEMA's National Flood Insurance Program (NFIP). The WRDA of 2007 extended Corps authority and allows the inclusion of all nonfederal levees on a voluntary basis. A

methodology for technical risk assessments of existing levee infrastructure is under development to evaluate levees nationally. Additional activities within this program include national teams to develop new policies concerning levee safety, such as inspections of existing levee systems, verification or establishment of existing geodetic control, minimum standards for new levee systems and interim risk reduction measures. Key policy issues in which close collaboration between the Corps, FEMA, and other stakeholders is necessary relate include mapping the flood hazard, inspection and assessment of levees, operation and maintenance of levees, and emergency response and evacuations.

(5) The Corps operates 75 power plants, which represent almost one fourth of the Nation's hydroelectric capacity or three percent of the Nation's total electric power generating capacity. Dams built by the USACE provide storage for municipal (including drinking water) and industrial water supply, irrigation, and fish and wildlife habitat. Additionally, 402 of the projects mentioned above (mostly lakes) are developed for recreational use. These projects accommodate nearly 250 million visits a year; the Corps estimates that one in 10 Americans visit a civil works project at least once a year. Visitors to these recreation areas generate 270,000 private and public sector jobs. USACE is one of the nation's largest provider of outdoor recreation, hosting 20% of visits to federal recreation areas on 2% of federal land.

(6) The transportation infrastructure developed in the Civil Works Program plays a role in national defense. Ports and waterways maintained by USACE serve the Navy, and are vital logistics links when large volumes of materiel and personnel must be moved around the country and around the world. USACE works with the Surface Deployment and Distribution Command (SDDC) and local port authorities to ensure that ports are ready to support movement of military equipment and supplies when needed. This partnership was especially effective in moving nearly all the Army's equipment and supplies necessary for Operations *Enduring Freedom* and *Iraqi Freedom*. Waterways built and operated and maintained by the USACE similarly have direct military uses for strategic mobility. Units of the Texas, Oklahoma, and Arkansas National Guard have conducted successful movements over the Arkansas, Mississippi, and Illinois Rivers to their summer training sites, and the 101st Air Assault Division has conducted movements by waterway from Fort Campbell, KY, to Louisiana. USACE flood risk management projects also contribute to force projection by protecting important highway and railway links. Thus, through activities as diverse as facilitating the movement of materiel to protecting vital infrastructure, the Civil Works Program contributes to National security.

### c. *The Environment.*

(1) *Project Activities.* The Civil Works Program makes important contributions to the Nation's environmental goals by constructing projects for restoration and protection of ecosystems and other environmental functions and values. Among the largest such projects underway in FY 2017 were South Florida Ecosystem Restoration (\$115 million in FY17), Columbia River Fish Mitigation (\$70 million funded that year), Poplar Island, MD (\$63 million), the Maywood, NJ, FUSRAP remediation site (\$34 million), Upper Mississippi River Restoration (\$33 million), Missouri River Fish and Wildlife Recovery (\$31 million in FY 2017), the Chicago Sanitary & Ship Canal Dispersal Barrier (\$12 million in FY 2014 to prevent the spread of Asian carp from the Mississippi Basin to the Great Lakes). Much of this work proceeds in partnership with other federal and state agencies or recognized Native American tribes, Alaska Natives, and local communities. In 2002, the Corps entered into a partnership with The Nature Conservancy to improve the management of U.S. rivers for restoration purposes while maintaining the projects' economic services. In addition, the Corps has agreements with the National Fish and Wildlife Federation and Ducks Unlimited to advance restoration of important ecological resources.

### (2) *Project Authorities.*

(a) The WRDA of 1990 established environmental restoration and protection as one of the primary missions in the planning, design, construction, operation, and maintenance of water resources projects - equivalent to navigation and flood risk management. This new direction stimulated the Corps and its non-federal project sponsors to plan and implement new projects with environmental restoration as a primary project purpose.

(b) Like other major Corps projects, Congress must authorize large restoration projects. In one of the largest environmental restoration and protection projects ever undertaken, the Departments of the Army

and the Interior have been cooperating with the State of Florida to restore the hydrologic regime of the Everglades in South Florida. Congress approved the Corps' Comprehensive Everglades Restoration Plan in Title VI of the WRDA of 2000, PL 106-541. The first feasibility study for a component of this project requiring specific authorization was completed in 2002.

(c) The Corps and the State of Louisiana are working together to restore and protect that State's shrinking coastal wetlands and stem an ongoing loss of 25 to 35 square miles per year. This ecosystem is vital to the Nation's environmental health for naturally filtering out water pollution and for providing critical winter habitat for 70% of the Nation's waterfowl. This ecosystem is also vital to the Nation's economy as the home of a major seafood industry. The wetlands and barrier islands also protect inland urban, industrial, and agricultural areas - including New Orleans and dozens of other communities that are home to a culture unique in America - from hurricanes and coastal storms. Work in Coastal Louisiana took on added urgency after Hurricane Katrina focused national attention on the role of coastal wetlands in attenuating storm surge and wave action.

(d) In addition to specifically authorized projects such as the Everglades and Coastal Louisiana restoration projects described above, environmental restoration is accomplished through three programmatic authorities for small projects. Under Section 1135 of the WRDA of 1986 (PL 99-662), the USACE is authorized to modify projects it constructed earlier in the interest of making them "greener." Section 1135 also authorizes the USACE to accomplish environmental restoration when the original Corps project contributed to environmental loss. Section 204 of the WRDA of 1992 provided authority for beneficial uses of dredged material. This authority allows the USACE to use material from the dredging of navigation projects for environmental restoration. The third authority is Section 206 of the WRDA of 1996. This provision establishes a program for Aquatic Ecosystem Restoration under which small projects may be constructed with no link to an existing Corps project required. Working toward a national goal of "no net loss of wetlands," the Civil Works Program is undertaking projects to restore existing wetlands and create new ones.

### (3) *Regulatory Program.*

(a) The USACE's regulatory program has a long history of protecting the Nation's waters. The Rivers and Harbors Act of 1899 authorizes the USACE to regulate, by permit, structures and/or work, including dredging and filling activities, in navigable waters of the United States. A principal objective of this program is to ensure that the navigable capacity of waterways is maintained for commercial and recreational navigation users. Over time, the Corps' "public interest review" has become an important part of the decision process used by Corps district commanders in issuing, issuing with conditions, or denying permit applications.

(b) In 1972, Section 404 of the Clean Water Act authorized USACE to regulate, by permit, dredging and fill material discharge activities in waters of the United States, including many wetlands. This Act expanded the Corps' regulatory responsibilities beyond those in the Rivers and Harbors Act of 1899 to all waters of the United States. Also, other environmental laws that were enacted in the late 1960s and early 1970s, including the National Environmental Policy Act, the Endangered Species Act and the National Historic Preservation Act, require federal decision makers to consider and take responsibility for the effects of their actions.

(c) Section 103 of the Marine Protection, Research and Sanctuaries Act of 1972, as amended, authorizes the USACE to issue permits for the transportation of dredged material for ocean disposal. In its determination, the Corps ensures that the dumping will not unreasonably degrade or endanger human health, welfare, or amenities, or the marine environment, ecological system, or economic potentialities.

(d) Rulings of the Supreme Court, including its *Solid Waste Agency of Northern Cook County (SWANCC)* decision in 2001 and the *Rapanos* decision in 2006 have concluded that USACE regulatory jurisdiction does not extend to all waters. These decisions have resulted in challenges to determining the limits of waters of the United States that are subject to the Corps Clean Water Act regulation, including the need to determine if particular waters have a significant nexus to traditional navigable waters. In 2015, the Environmental Protection Agency and USACE issued a new "Waters of the United States" regulation, specifying which bodies of water were and weren't covered under Sec. 404 of the Clean Water Act. Due

to court action, this regulation was never implemented, and in February 2017 President Trump ordered a review of the regulation.

(e) Permit decisions are made in the regulatory program by evaluating the effects of activities within the Corps control, and evaluating benefits and detriments of the proposal on the public interest. The evaluation process promotes the balancing of environmental protection with responsible economic growth. In FY 2016, the Corps worked with project proponents to evaluate tens of thousands of activities in the Nation's waterways and wetlands, coordinating and consulting with other agencies, tribes and the public in many cases. A total of nearly 55,000 nationwide or regional general permit verifications were completed for activities in waters with minimal effects. For those projects that required individual permit (IP) evaluation because they did not meet the terms and conditions of any general permit, the Corps issued IPs for 3,200 activities, including special conditions as necessary, and denied permits for 87 activities.

(4) *Stewardship*. The Corps is steward for about 12 million acres (18,831 square miles) of land and water in 42 States. Conservation of forests, range wildlife habitat, fisheries, and soils involves multiple uses of resources and sound ecosystem management principles. The USACE accomplishes this through a mix of its own management capabilities, partnerships with State and local governments, volunteers, and working agreements with a wide range of interest groups.

(5) *Compliance*. The Corps conducts compliance assessments at all of its projects on a five-year cycle through the environmental compliance assessment program. The Environmental Review Guide for Operations (ERGO), the tool used to conduct assessments, is a checklist containing federal and state environmental statutes and USACE requirements. Project and facility managers, as well as external organizations, use ERGO to systematically locate and correct environmental deficiencies.

(6) *Nonstructural Flood Risk Management*. In recent years the Corps has placed an increasing emphasis on nonstructural approaches to flood management. Nonstructural alternatives focus on addressing development in the floodplain. Alternatives include floodplain zoning, participating in the National Flood Insurance Program (NFIP), developing and implementing flood warning systems (coordinated with the National Oceanic and Atmospheric Administration's flood warning program) and emergency evacuation plans, and flood proofing individual structures as well as removing structures from extreme flood hazard areas.

(7) *Civil Environmental Activities' Relationship to Army Missions*. Environmental activities in the Civil Works Program are essential elements of the Army's Environmental Strategy for the 21st Century. People who learn their specialties in Civil Works missions that concern natural and cultural resources, water quality, flood plain management or hazardous waste management help the Army go "beyond compliance" to take on a leadership role in natural resources stewardship. Civil Works expertise helped the Army develop such tools as the Environmental Compliance Assessment System (ECAS) and Integrated Training Area Management (ITAM). The Civil Works Program is responsible for about half the Army's land holdings, and is familiar with balancing preservation of the natural environment with human use - a major issue facing the Army. This program is also the Army's reservoir of cultural resources expertise, which the Army has used on several priority missions.

d. *Emergency Preparedness and Disaster Response*.

(1) The USACE responds to the Nation's needs in case of natural or man-made disasters and emergencies. The USACE programs provide a wide variety of assistance to protect human life and improved property, reduce human suffering, help communities recover from the effects of disasters, and mitigate damage and future threats. Response and recovery activities supplement State and local efforts. When disasters occur, USACE teams and other resources are mobilized from across the country to assist our local districts and offices to deliver our response missions. USACE has more than 50 specially-trained response teams supported by emergency contracts to perform a wide range of public works and engineering-related support missions. USACE uses pre-awarded contracts that can be quickly activated for missions such as debris removal, temporary roofing, commodities distribution, and generator installation. Every year, USACE, as part of the federal government's unified national response to disasters and emergencies, deploys hundreds of people to provide technical engineering expertise and to promote

capacity development at home and abroad. In 2016, USACE had 1,096 personnel deployments in response to one or more of 33 disaster declarations.

(2) Under PL 84-99, the USACE undertakes planning and preparedness activities for all types of natural disasters, and provides response and recovery activities necessitated by floods and coastal storms. The Flood Control and Coastal Emergencies (FCCE) appropriation funds all PL 84-99 activities. Included in these preparedness and response efforts are: disaster preparedness measures; advance measures to alleviate high potential flood threats; flood fighting activities; preservation of threatened federally-constructed shore protection projects; and life-saving rescue operations.

(3) Recovery and mitigation measures include repair and rehabilitation of damaged flood control works and shore protection projects or nonstructural projects. PL 84-99 also authorizes the USACE to provide emergency supplies of clean water to localities whose water source has been contaminated, and to drought-affected areas. In addition, the USACE is authorized to provide essential services and restore essential public infrastructure for a period of up to 10 days in any area victimized by a natural disaster for which the Governor of a State has requested federal assistance under the Stafford Act authority.

(4) Under the Robert T. Stafford Disaster Relief and Emergency Assistance Act (42 USC 5121 et seq.), FEMA, under the DHS, has developed the National Response Framework (NRF), which coordinates the execution of response and recovery operations of the 28 federal signatory departments and agencies. USACE uses its engineering expertise and its response and recovery capabilities to carry out DOD's responsibilities under the NRF. DOD has delegated its responsibility for Emergency Support Function (ESF) #3, Public Works and Engineering, to the USACE.

(5) As the lead DOD (and federal) agency for ESF #3, the USACE has a number of standing missions, to include provision of water, ice, emergency power, debris removal, temporary housing, and temporary roofing. Other missions in the Public Works and Engineering area are assigned by the FEMA to the USACE as needed. All of these missions are tailored to the needs of, and coordinated with the impacted State. FEMA funds all of these missions under a reimbursable agreement with an approved mission assignment. Each mission assignment is based on the capabilities of the USACE, including its significant and responsive contracting capability. The Joint Staff, J-3, Joint Directorate of Military Support (JDOMS), coordinates DOD requirements not in the realm of ESF #3 missions.

e. *Homeland Security.* The Corps has developed in-depth anti-terrorism/protection warfighting function expertise, including many skilled engineers with experience on Khobar Towers, the Murrah Federal Building in Oklahoma City, the World Trade Center, the Pentagon, and other sites. It leverages that expertise to protect critical water resources infrastructure from terrorists. Over past few years the Corps has been working with other agencies, including the Bureau of Reclamation, Department of Energy, TVA, EPA, and FBI to develop comprehensive security assessment processes to identify risks to critical facilities such as locks, dams and hydropower facilities

### 18-8. Research and Development

a. The Engineer Research and Development Center (ERDC) is the Corps' premier research organization, solving the toughest challenges faced by our Nation and the military today. Its unmatched force protection technologies save lives, both Soldiers and Civilians, overseas and at home. ERDC innovations allow our forces to quickly deploy anywhere in the world for military and humanitarian missions. ERDC solutions help our Soldiers move faster, stay safer, and dominate the battlefields of today and tomorrow. Advanced R&D also addresses national environmental and water problems that affect our lives in flood control, threatened and endangered species, contaminants, navigation, infrastructure, hurricane and storm protection, and other diverse areas. Unique, world-class equipment and facilities, ranging from the world's fastest supercomputers to one-of-a-kind physical models give USACE R&D an innovative edge. ERDC's biggest strength is its people—internationally recognized engineers, scientists, physicists, mathematicians, technicians and support personnel (2,500 strong) – all helping to make the world a safer and better place through innovative solutions to our Nation's toughest challenges.



b. The Army Corps of Engineers Civil Works Program pursues an R&D effort to take advantage of rapidly developing technologies and techniques that will promote significant monetary savings and greater reliability, safety, enhanced efficiency and environmental sustainability of its civil works activities. The R&D program is formulated to support each of the assigned Civil Works missions and their supporting core of technical competencies, environmental restoration and stewardship, economics and decision support, cold regions engineering and dredged sediment management. Technology infusion is pursued, in conjunction with Regional Business Centers (USACE Divisions) and established Centers of Expertise as part of the overall efforts to maintain a trained and ready engineering force capable of responding to a wide range of contingency situations.

c. The Corps conducts Civil Works-related R&D through its Engineer Research & Development Center (ERDC) and its Institute for Water Resources (IWR). The ERDC is headquartered at the Waterways Experiment Station facility, Vicksburg, MS. It consists of seven individual research laboratories:

- (1) Coastal and Hydraulics Laboratory, Vicksburg, MS
- (2) Cold Regions Research and Engineering Laboratory, Hanover, NH
- (3) Construction Engineering Research Laboratory, Champaign, IL
- (4) Environmental Laboratory, Vicksburg, MS
- (5) Geotechnical and Structures laboratory, Vicksburg, MS
- (6) Information Technologies Laboratory, Vicksburg, MS
- (7) Topographic Engineering Center, Fort Belvoir, VA

d. The Institute for Water Resources (IWR), headquartered at Fort Belvoir, VA, provides economic and decision support-related R&D support. Its Hydrologic Engineering Center is located in Davis, CA.

### Section III Support to Other Government Agencies

#### 18-9. Overview

The USACE provides engineering and construction support to about 70 non-DOD federal agencies, plus numerous States, local, tribal and foreign governments under the Interagency and International Services Program. Funds for this program are provided by the agencies receiving support. USACE support of other entities' infrastructure programs includes support to the DHS by managing the design and construction of border control and detention facilities for the Customs and Border Protection Agency and emergency management assistance to the Federal Emergency Management Assistance Agency, construction of facilities for the State Department, and renovation of health care facilities for the Department of Veterans Affairs. The USACE also supports programs and projects of other federal agencies designed to meet important national environmental objectives. These include the Superfund Program of the U.S. Environmental Protection Agency (EPA). These support activities in support of our domestic stakeholders totaled \$1.04 billion in expenditures in FY16, an increase of \$381M from FY15. Some key domestic stakeholders in terms of overall program execution include the Department of Veterans Affairs (\$311M), U.S. Customs and Border Protection (\$86M), National Aeronautics and Space Administration (\$63M), Department of Energy (\$34M), Federal Emergency Management Agency (\$34M), Department of Interior (\$30M), U.S. Agency for International Development (\$12M), Millennium Challenge Corporation (\$7M), and the Department of State DoS (\$5M).

#### 18-10. Agencies Supported

a. Department of Energy (DOE): In FY16, USACE signed new five-year Memorandum of Agreements (MOA) with the National Nuclear Security Administration (NNSA), the DoE Office of Environmental Management, and the DOE Office of Project Assessments. In addition, USACE and NNSA signed an Enterprise Program Management Plan that provides the framework for supporting NNSA's design and construction program.

## HOW THE ARMY RUNS

b. United States Agency for International Development (USAID). Significant FY16 accomplishments include continued technical assistance and capacity development for water resource management in Pakistan, assessment of the USAID water reservoir program in Honduras to reduce the impact of drought, continued construction of cyclone shelters and other infrastructure in Bangladesh.

c. Department of State (DoS). In FY16, in support of the U.S. Embassy Baghdad Chief of Mission, USACE and the Government of Iraq (GOI) signed a new agreement under the Foreign Assistance Act to serve as the GOI's Engineer and provide construction oversight of a contract to perform grouting operations for Mosul Dam. The Corps also continued leveraging its extensive knowledge of river basin management, disaster preparedness and response, and collaborative planning to support the Department of State's Lower Mekong Initiative (LMI) to enhance regional cooperation and sustainable development in the Mekong region of Southeast Asia.

d. Department of Interior (DoI). USACE and DOI signed a new MOA covering the full range of support that USACE provides to DOI. The new agreement replaces separate MOAs with each of the DOI Bureaus and agencies.

e. Millennium Challenge Corporation (MCC): USACE signed three new interagency agreements for engineering and environmental services projects to support the MCC mission. Additionally, four existing interagency agreements were extended to continue to provide assistance in several countries in Africa as well as in Jordan and the Philippines.

f. Nuclear Regulatory Commission (NRC). An Interagency Agreement was signed with the NRC in FY13 to provide technical expertise in assessing flood risk to downstream nuclear power plants from USACE and other dams. The work is part of flood hazard reevaluations required by NRC following the 2011 accident at the Fukushima Dai-ichi nuclear power plant in Japan.

g. Department of Veterans Affairs (DVA): USACE's partnership with the Department of Veteran's Affairs resulted in formal agreements for design and construction oversight of fourteen Major Medical Facilities in eight states valued at approximately \$6B. In FY16, USACE and DVA's Office of Construction and Facilities Management jointly developed an Enterprise Program Management Plan (EPgMP) as a framework for program execution. A Program Management Office (PMO) was established in the IIS Division and staffed with two full-time Program Managers. Future PMO staffing will include additional dedicated Engineering and Construction Division personnel and dedicated positions at USACE Division with DVA medical construction projects.

h. Customs and Border Protection (CBP): USACE has a long established relationship with U.S. Customs and Border Protection (CBP), including supporting the completion of border fence with real estate acquisition, environmental services, design, construction, maintenance, repair and replacement supporting the execution of Secure Fence Act mandates in 2006-2008. USACE is currently providing programmatic support to Customs and Border Protection in their mission to construct a physical wall along the southern border in accordance with the Executive Order for Border Security and Immigration Enforcement Improvement. Presently, USACE is conducting a market survey to assess the construction interest and capacity which will inform the acquisition strategy to conduct any assigned construction mission. A solicitation for sources sought to gauge industry capability and interest closed on 1 March 2017 and the responses are being evaluated. The draft Acquisition Plan has been submitted to the PARC. CBP issued two RFPs on 17 March 2017 to acquire multiple conceptual wall designs with the intent to construct multiple prototypes. The prototypes will inform future design standard(s) which will likely continue to evolve to meet USBP's requirements. USACE representatives for Fort Worth District, Engineer Research and Development Center, and Protective Design Center provided technical assistance in the development of the solicitation. The selection boards for Phase 1 have concluded. Phase 1 evaluated the responses to the solicitations and will result in invitation to the most qualified interested parties to submit their concepts for evaluation in Phase 2. USACE will have representatives on the boards to assist with the selection. The Interagency Agreement (IAA) between USACE and CBP to perform programmatic, acquisition, project planning, and project execution activities for CBP's Border Barrier Systems requirements per Executive Order 170125 has been signed. The initial amount of \$11.5M has been provided to USACE to work on the new border barriers. The first project segment of

2.93 miles in the Rio Grande Valley has been identified for award in the near future. The Project Management office-Border Infrastructure has met with Customs and Border Protection and the International Boundary and Water Commission to coordinate plans for the levee wall construction. The omnibus bill to fund the government through the end of fiscal year does not include funding requested by President Trump to build a border wall or fencing on areas of the U.S.-Mexico border where no fencing currently exists. The omnibus bill does include funds for border security in to include replacement of existing fencing as well as patrol and access roads. USACE is working on projects for replacement of approximately 40 miles of fence in the San Diego and El Paso Sectors and the installation of gates in Rio Grande Valley.

## Section IV Engineer Overseas Activities

### 18-11. Overview

The USACE conducts a broad range of foreign activities. Many are exclusively in support of U.S. forces overseas, but others are considered part of the civil functions of the Army. In coordination with the Director of Strategy, Plans, & Policy (Army G3/5/7), the ASA (CW) provides program direction to the foreign activities of the Corps, except those which are exclusively in support of U.S. military forces overseas. In FY 2016, the Corps supported U.S. foreign policy in more than 100 countries. The largest of the Corps overseas programs was in Afghanistan, where USACE was involved in construction of roads and other civilian infrastructure as well as facilities for the new Afghan Army. USACE support overseas includes Humanitarian Assistance (HA) projects (schools, clinics, water wells, etc.) for the Combatant Commands (CCMD), assisting the Millennium Challenge Corporation with major infrastructure projects and support to the U.S. Agency for International Development. The USACE also supports U.S. objectives by using its water resources expertise for capacity development for developing nations. Examples of this activity include technical advice and consensus building for the Mekong River Commission and strategic water resources engagement with the Brazilian Army Engineers.

### 18-12. Foreign Military Sales

As the DOD Construction Agent in many parts of the world, the Corps provides international security assistance to eligible foreign nations as an instrument of the National Security Strategy (NSS) and DOD Policy. Under the authorities of the FMS Program, the Corps provides reimbursable design and construction services for defense infrastructure to eligible foreign nations as approved by the Deputy Assistant Secretary of the Army (Defense Exports and Cooperation) (DASA(DEC)) and authorized by the Defense Security Cooperation Agency (DSCA). Some of the key cases that were funded in FY16 were the Saudi Arabian Royal Air Force Apache facilities, Shape International School in Belgium, continued work in Israel military infrastructure as well as support to our Air Force for their Israel program; work in the AFRICOM 2282 programs of Counterterrorism Partnership Program Funding (CTPF)/Build Capacity of Foreign Security Forces Program (BPC), and other high-impact projects in Korea, Jordan, Kuwait, and Armenia. USACE continues to effectively support our existing partners while establishing new relationships by developing cases in countries throughout the globe, including Korea, Paraguay, Maldives, Guatemala and Ukraine.

- CENTCOM: 71 active cases with a total program value of \$2.5B. USACE's projects in the region include support facilities to the Qatar Apache helicopter and Patriot defense program.
- EUCOM: 58 active cases with a total program value of \$1B. USACE's NATO SHAPE school renovation is one of our most important projects within the region.
- PACOM: 4 active cases with a total program value of \$315M. The C-17 India case continues to be our largest FMS effort in the PACOM region
- AFRICOM: 18 active cases with a total program value of \$16.5M. Typically warehouses, vehicle maintenance and hangars are provided under the 1206/2282 Building Partner Capacity Program.

## HOW THE ARMY RUNS

- NORTHCOM: 1 active case with a total program value of \$10M. USACE's core competencies are used in the program including our geospatial technical expertise for our C4ISR case in Canada.
- SOUTHCOM: 3 active cases with a total program value of \$16.2M. USACE is involved in facilitating enhanced commercial navigation for Brazil through the technical assistance in water resource master planning.

### **18-13. Civil-Military Emergency Preparedness**

USACE executed 24 international disaster preparedness events in support of Geographic Combatant Command (GCC) FY16 security cooperation objectives. These activities assist the countries in building capacity for "All-Hazards" preparedness and consequence management. Focused on NATO, other partners, and countries in the SOUTHCOM AOR; USACE conducted 24 events (+8 from FY15) and received funds of \$1.5M from the Wales Initiative Funds (WIF), Defense Environmental International Cooperation (DEIC), and Traditional COCOM Activities (TCA) sources.

### **18-14. Engineer Engagements**

USACE continued to receive international delegations seeking best practices and information exchange on various technical and engineering issues including establishing a Corps of Engineers-like capability, consequence management, and integrated water resource management. In FY16 USACE hosted delegations from Afghanistan, Pakistan, Taiwan, Korea, China, the Brazilian Chief of Engineers, and the Lower Mekong River Commission. We also hosted groups from Chile, Egypt, Israel, Hungary, Laos, Mexico, Mongolia, Morocco, Nepal, Palestine, Paraguay, China, Peru, Russia, Tajikistan, Tanzania and Vietnam under the State Department's International Visitor Leadership Program. Through the Engineer and Science Exchange Program, USACE created a new exchange program with the Japanese Ministry of Defense to further their knowledge of US Anti-Terrorism/Force Protection protocols. USACE obligated over \$606K of the XISQ Security Cooperation Funds to support engagements in India, Viet Nam, China, Taiwan, Laos, Mongolia, Colombia, Honduras, Swaziland, and Mexico addressing challenges of national and global significance related to water resources, disaster preparedness, infrastructure development, and environmental protection. USACE continues to embed Engineer Liaison Officers with all of the Geographic Combatant Commands, several Army Service Component Commands, with USAID, and other agencies.

### **18-15. Theater Security Cooperation and Shaping (XISQ MDEP)**

The Army established security cooperation (SC) as an enduring mission to meet the intent of using steady-state security cooperation as a means of effectively and efficiently achieving National Security Strategy, National Defense Strategic Guidance, Quadrennial Defense Review, National Military Strategy, and Combatant Commanders objectives. This mission is codified in documents such as the Army Vision, Army Operating Concept, Army Strategic Guidance for Security Cooperation, AR 11-31, Army Security Cooperation Policy, and DA PAM 11-31, Army Security Cooperation Handbook. USACE is distinctively postured to shape the security environment. Regionally aligned and globally present, USACE employs its unique array of interagency and international partnerships, authorities, acquisition tools, and expertise to address a broad range of technical and engineering needs that enables the US Government to maintain influence and access, strengthens relationships and integration across the Joint, Interagency, Intergovernmental, and Multinational (JIIM) community, and builds partner capacity. As the momentum for conducting security cooperation activities has grown, there has been a corresponding increase in the recognition of need and demand for USACE capabilities within the Army, Combatant Commands, and interagency as integral and essential to their respective national and theater security cooperation strategies. The following examples highlights how USACE capabilities are being employed to shape the security environment:

- a. Assisting strategic partners to address critical water and environmental security challenges in the Mekong region of Southeast Asia, the Baltics and Eastern Europe, the Paraguay and São Francisco River Basins in South America, and the Nigerian Waterway and Senegal Basin in Africa by leveraging our

JIIM partnerships, extensive knowledge of river basin management, risk management, and disaster preparedness and response, and collaborative planning approaches to enhance regional cooperation, sustainable development practices, and resiliency (supports multiple PACOM LOEs including China, Allies and Partners, and All Hazards, SOUTHCOM LOEs 4, Humanitarian Assistance/Disaster Relief and 6, Critical Access and Relations, EUCOM's Disaster Preparedness and Environmental Security LOAs, and AFRICOM LOEs);

b. Assisting in key partner nation Army Engineer transformation initiatives through bilateral exchanges in countries such as Brazil, Colombia, Chile, Peru, Angola, Kenya, and Liberia (supports SOUTHCOM LOE 5, Defense and Security Sector Reform/Defense Institution Building and all AFRICOM LOEs);

c. Responding to the Brazilian water agency request for assistance to assess and recommend water quality monitoring and sediment management solutions to address the recent mine breaches in the Minas Gerias region and impacted portions of the Rio Doce (supports SOUTHCOM LOEs 4, Humanitarian Assistance/Disaster Relief and 6, Critical Access and Relations); and

d. Maintaining critical access and strategic partnerships by conducting a series of annual subject matter expert technical exchanges and consultations requested by the Panama Canal Authority on the operation, administration, management, preservation, maintenance, and modernization of the Canal (supports SOUTHCOM LOE 6, Critical Access and Relations).

## **18-16. Support for United States Agencies Overseas**

The Corps is also called upon to provide support for U.S. agencies overseas. For example, the Corps: supports the U.S. Agency for International Development following natural and man-made disasters; builds border facilities for the Republic of Georgia Border Guard and U.S. Customs and Border Protection; provides hydrologic modeling training for Ethiopia and Kenya; and performs government due diligence for major infrastructure projects funded by the Millennium Challenge Corporation.

## **Section V**

### **Support to Unified Combatant Commanders**

#### **18-17. Benefits to Warfighting Capabilities**

The Civil Works Program provides the USACE with a unique capability in DOD. The USACE's extensive professional staff of engineers, scientists, economists, etc.; provide the critical teamwork necessary to plan engineer infrastructure improvements and institution building at the national level. The training and experience gained from the Civil Works program is leveraged by the USACE's Field Force Engineering (FFE) capabilities to provide support to unified CCDRs and their Army Service Component Commands (ASCC). The infrastructure these engineers build provides the facilities and enablers for operations in the future. USACE uses its regional alignment and global presence, unique authorities, agreements, and technical and engineering capabilities to deliver integrated solutions to support National Security Strategy and advance America's interests at home and abroad. USACE is working with partners around the globe to develop innovative solutions aimed at strengthening partner nation capacity to address resource security and disaster risk management challenges, which are critical to achieving state and regional stability, sustainability, and economic development. It is actively engaged with the Combatant Commands (CCMD), Army Service Component Commands (ASCC) and interagency partners to maintain partnerships with key allies, build partner capacity, and enhance security around the globe. USACE leverages its expeditionary relationships with joint, interagency, intergovernmental, and multi-national partners, and a diverse mix of civilian and military technical and engineering expertise to support CCMD, ASCC and interagency activities across the globe. USACE supports the Combatant Commands' strategic objectives by delivering collaborative solutions through a "toolkit" of engineering and technical capabilities. USACE Major Subordinate Commands have been

assigned to support to each of the Geographic Combatant Commands (GCC) and we have USACE LNO's embedded in each of the GCC's as well as select ASCC's and within SOCOM.

### **18-18. Overview of Support to Unified Combatant Commanders**

Expertise in water resource development, flood risk management, waterway operations, dredging, coastal engineering, environmental stewardship, and disaster response supplement the skills maintained through the Army's MILCON and installation support programs. These expert capabilities are routinely called upon by the warfighting CCDRs and other DOD agencies. When the Army goes to war, USACE personnel use the experience they have gained in the Civil Works and military programs to provide timely analysis and solutions to the warfighters. The USACE's knowledge of beach dynamics, including the Sea State Prediction Models developed at ERDC's Coastal & Hydraulics Laboratory, helps determine sites for shore landings. When combined with its terrain mobility models, the USACE can provide commanders the most effective plan for logistics-over-the-shore sites in combination with the inland road network to optimize reception, staging, and onward movement in the area of operations. Corps expertise in soil mechanics determines the best routes for armored vehicles. Often roads are built using technologies developed in the Civil Works Program. Corps experience gained from work on winter navigation helps the Army to cross frozen rivers. Commanders at all levels make use of geospatial products and satellite-based navigation systems developed at the Topographic Engineering Center at Fort Belvoir, VA.

## **Section VI**

### **Summary and References**

#### **18-19. Summary**

The Army, through its civil functions, provides valuable services in maintaining and enhancing the economic and environmental health of the Nation. Civil functions also continue to prove invaluable in furthering national security objectives, both directly and indirectly. The financial and personnel resources associated with these functions are principally authorized and funded under the WRDAs and annual Energy and Water Development Appropriations Acts, respectively. Consequently, civil functions activities, as well as the significant training of the USACE personnel they provide, are at virtually no cost to the DOD's military budget. USACE is a globally-recognized leader in military and civil engineering and science. Its Civil Works mission provides a key foundational component of the nation's public infrastructure that facilitates economic growth, quality of life, environmental health and national security for the American people. The Corps' highly skilled workforce provides significant value to the nation—the economy, security and quality of life. But the Corps does not do anything alone. Many partners in other services—interagency, local/regional/state leaders, and contractors—help achieve the Civil Works mission.

#### **18-20. References**

- a. Civil Works Strategic Plan, 2014-2018.
- b. CALL Study: USACE Lessons and Best Practices (<http://usacac.army.mil/organizations/mccoe/call/publication/16-01>).
- c. HQDA General Orders No. 3, Assignment of Functions and Responsibilities within Headquarters, Department of the Army, 9 July 2002.
- d. Public Law 84-99, Amendment of Flood Control Act of August 18, 1941 (Emergency Flood Control).
- e. Public Law 91-611, Flood Control Act of 1970.
- f. Public Law 93-288, Disaster Relief Act of 1974 (also known as the Stafford Act).
- g. Public Law 99-433, DOD Reorganization Act of 1986 (also known as the Goldwater-Nichols Act).
- h. Public Law 99-662, WRDA of 1986.
- i. Public Law 105-245, Energy and Water Development Appropriations Act, 1999.
- j. Public Law 105-277, Omnibus Consolidated and Emergency Supplemental Appropriations Act, 1999.

## CIVIL FUNCTIONS OF THE DEPARTMENT OF THE ARMY

- k. Public Law 106-541, WRDA, 2000.
- l. Public Law 110-114, WRDA, 2007.
- m. Public Law 113-121, Water Resources Reform and Development Act (WRRDA), 2014.
- n. Public Law 114-322, Water Infrastructure Improvements for the Nation Act, 2016.

**This page is intentionally left blank**



## Chapter 19

### Public Affairs

#### Section I Introduction

##### 19-1. Chapter Content

This chapter provides insights into the roles, functions, and mission of public affairs (PA). Section I describes how the PA community supports the commander through mission, principles, responsibilities, activities, and tasks. Section II describes PA organizations, to include headquarters, units, sections, and detachments. Section III provides a summary, key terms, and applicable references.

##### 19-2. Public Affairs Mission

- a. The mission of Army PA is to fulfill the Army's obligation to keep the American people and the Army informed, and helps to establish the conditions that lead to confidence in the Army and its readiness to conduct full-spectrum operations.
- b. Army PA activities derive from Title 10, Chapter 303, Section 3014, U.S. Code, which requires the Secretary of the Army (SECARMY) to designate a single office career field to conduct PA.
- c. Army PA comprises internal information, public information, and community engagement activities directed toward both internal and external publics with interest in the Department of Defense (DOD).

##### 19-3. Public Affairs Principles of Information

The Principles of Information constitute the underlying PA philosophy for the DOD. Army PA professionals support the DOD policy to make available timely and accurate information so that the public, Congress and the news media may assess and understand the facts about national security and defense strategy. The following principles apply:

- a. Information will be made fully and readily available, consistent with statutory requirements, unless its release is precluded by current and valid security classification. The provisions of the Freedom of Information Act will be supported in both letter and spirit.
- b. A free flow of general and military information will be made available, without censorship or propaganda to the men and women of the Armed Forces and their dependents.
- c. Information will not be classified or otherwise withheld to protect the government from criticism or embarrassment.
- d. Information will be withheld only when disclosure would adversely affect national security or threaten the safety or privacy of the men and women of the Armed Forces.
- e. The Department's obligation to provide the public with information on its major programs may require detailed PA planning and coordination within the Department and with other government agencies. The sole purpose of such activity is to expedite the flow of information to the public. Propaganda has no place in DOD PA programs.

##### 19-4. Public Affairs Responsibilities

- a. Army PA doctrine and policy is consistent and compatible with joint PA doctrine and policy, and DOD and DA policies. FM 3-61 is the doctrinal manual for Army PA operations. It describes the fundamental principles and concepts that provide information to internal and external national and international key actors and publics—Soldiers, family members, retirees, political leaders, allies and adversaries, as well as PA responsibilities, roles, missions, capabilities and organizations in the operational and home station environment.

b. PA is a command responsibility. At each level of command, PA officers report directly to the commander. Commanders at all levels ensure that PA planning is coordinated and de-conflicted with other information-related capabilities (IRCs) through command working and planning groups.

c. The commander may communicate through a command-designated official spokesperson, but the success or failure of the PA program hinges on the commander's personal support and direct involvement. No PA spokesperson can fully capture the commander's personal perspective and responsibility in communicating the leadership position.

d. The PA officer serves on the commander's personal staff and supervises PA staff sections or attached PA units. The PAO develops strategies, leads, and supervises the conduct of internal information, public information and community engagements. The PAO's principal role is to provide advice and counsel to the commander and the staff on how affected external and internal publics will accept and understand the unit's policy and operations.

e. Commanders are authorized to designate spokespersons to release information pertaining to their command; because PA is an inherently governmental function, official spokespersons will be military or DOD / DA civilian employees.

f. Commanders and PA professionals should educate and encourage all their military personnel, civilian employees, and contractors to tell the Army story by providing them with timely information that is appropriate for public release. By projecting confidence, commitment and factual information during interviews or in other interactions with families and friends, Army personnel can help promote public understanding of military operations and activities.

### 19-5. Public Affairs Activities

a. PA activities synchronize actions and communication across three functional areas: internal information; public information; and community engagement. PA staffs develop communication policies, plans and programs in support of command objectives and operations. The current global, technological information environment blurs the lines that once separated functional areas; information shared with one audience can be expected to be known to many others (e.g., command web sites are tools of internal information and public information activities).

(1) *Public Information.* Public information is the communication between the Army and local, national, and international publics through the use of coordinated programs, plans, themes, and messages – consistent with standards of security, accuracy, policy and propriety; and with the DOD Principles of Information (see Fig 19-1). Information technology provides a wide range of Internet-based information opportunities, to include command web sites and social media, for public information strategies. However, public information remains largely a matter of ensuring media representatives have access to information they need to report on military policy and operations. Media activities provide information to a wide range of publics within the U.S. and internationally. Commanders and their PA staffs plan for media briefings and interviews, issue statements, respond to queries, arrange for access to operational units, and provide to the media appropriate equipment, transportation, and communications support. Media plans include specific provisions for each phase of operations.

(2) *Internal Information.* Internal information is that communication to internal military, civilian and contract employees and their family members, intended to help members of the command understand organizational goals, operations, and significant developments. PA professionals develop strategies to use and synchronize information through installation and organizational publications, social media platforms, Internet-based multimedia products and town-hall-style meetings. PA professionals assess and leverage Internet-based capabilities such as social media and email to quickly and accurately communicate emergencies, operational changes, and hazards, for example, with their publics. During a military operation, commanders consider all dissemination capabilities available to communicate releasable details and the role of the military in the operation.

(3) *Community Engagement.* Community engagement is the process of working collaboratively with, and through, groups of people affiliated by geographic proximity or special interest to enhance the understanding and support the Army's / command's communication objectives. Objectives can include increasing public awareness and support to the Army, minimizing disruption to the mission, and support for recruiting / retention of the All-Volunteer Force. PA professionals assess and develop strategies for key leader engagements, relationship-building with officials, community influencers, organizations, businesses and individuals with interest in the Army.

## DOD Principles of Information

It is DOD policy to make available timely and accurate information so that the public, the Congress, and the news media may assess and understand the facts about national security and defense strategy. Requests for information from organizations and private citizens shall be answered quickly. In carrying out that DOD policy, the following principles of Information shall apply—

- Information shall be made fully and readily available, consistent with statutory requirements, unless its release is precluded by national security constraints or valid statutory mandates or exceptions. The "Freedom of Information Act" will be supported in both letter and spirit.
- A free flow of general and military information shall be made available, without censorship or propaganda, to the men and women of the Armed Forces and their dependents.
- Information will not be classified or otherwise withheld to protect the Government from criticism or embarrassment.
- Information shall be withheld when disclosure would adversely affect national security, threaten the safety or privacy of U.S. Government personnel or their families, violate the privacy of the citizens of the U.S., or be contrary to law.
- The DOD's obligation to provide the public with information on DOD major programs may require detailed Public Affairs (PA) planning and coordination in the DOD and with the other Government Agencies. Such activity is to expedite the flow of information to the public; propaganda has no place in DOD PA programs.

Source: DODD 5122.5, Sep. 27, 2000

**Figure 19-1. Department of Defense Principles of Information**

### 19-7. Public Affairs Tasks

Within the framework of the three PA functional areas, Army PA core tasks are fundamental to the commander's communication program and objectives—

a. *Provide Advice and Counsel to the Commander.* The PAO is the commander's senior advisor on PA strategies and programs. The PAO maintains direct and timely access to the commander and establishes effective staff relationships in order to maintain situational awareness and access during planning.

b. *Conduct PA Planning.* Continuous, collaborative planning is a core task for developing a synchronized, cohesive, and comprehensive PA plan that meets the commander's communication objectives. PA planning products include—

(1) *PA Assessment.* The PA assessment addresses all aspects of the information environment, whether or not they are under the commander's control. Primary emphasis is placed on identifying, measuring, and evaluating the implications of the external information environment that PA does not control, but can inform through a coherent, comprehensive strategy and its early integration into the commander's planning and decision-making process.

## HOW THE ARMY RUNS

(2) *Themes, Messages, and Talking Points.* PA professionals advise commanders on the use of PA themes, messages, and talking points to tailor and guide unit communicators that are nested with the higher headquarters communication objectives and guidance.

(3) *PA Running Estimate.* The PA running estimate is a continuous assessment of the current PA situation. Detailed estimates are developed in the planning stage and are continuously updated. The estimate describes the existing global information environment (GIE), emerging trends, current events, and internal and external communication issues.

(4) *PA Communication Plans.* PA communication plans support the planning, preparation, execution and assessment of the commander's communication objectives. Communication planning is the commander's blueprint and design for coordinating and synchronizing themes, messages, images, and actions to support PA and other information-related objectives. Synchronization ensures the integrity and consistency of command themes and messages to the lowest tactical level.

(5) *Proposed PA Guidance.* PPAG recommends mission-specific guidance to support public discussion of the operation. PPAG is created at the local level and submitted through command channels for approval by Office of the Assistant Secretary of Defense Public Affairs (OASD (PA)). OASD(PA) is the sole approval authority for PPAG. PPAG becomes Public Affairs Guidance (PAG) upon approval and publication. Development of additional or supplemental PPAG continues as needed.

c. *Conduct PA Training.* PA training should follow the operations process of plan, prepare, execute, and assess in unit training and leader development by using unit training management as discussed in ADRP 7-0. PA professionals should participate in and use the military decision-making process to plan PA training. PA professionals train and guide non-PA communicators; allies and international partners; and others to understand the role of the media and the opportunity and responsibilities associated with media interactions.

d. *Conduct Media Facilitation.* Media facilitation is the process of planning, preparing, executing, and assessing a media engagement. Since engagements with journalists can be unplanned, the PA professional will anticipate and prepare the command with specific guidance about command media policies and appropriate tips and tactics.

e. *Conduct Public Communication.* Public communication is the communication between the Army and local, national, and international publics through the use of coordinated programs, plans, themes, and messages. It involves the receipt and exchange of ideas and opinions that contribute to shaping public understanding of, and discourse with the Army. Public communication includes the release of official information through news releases, public service announcements, media engagements, multimedia Internet-based sites, and social networks; it supports the commander's responsibility to keep the American people and the Army informed. PA professionals are aware of the opportunities and challenges associated with today's multiple media platforms, to include understanding audience preferences, access, and behaviors.

(1) Traditional media, like television, radio, newspapers and magazines exist often in both original print or broadcast form and online.

(2) Internet-based media include online journals, magazines and web sites of 'traditional' media like television, radio, newspapers and magazines. Many of these have 'traditional' editors, legal offices and even ombudsmen.

(3) Internet-based Blogs, microblogs, and multi-author blogs (MAB); self-published books; and community radio have removed the traditional editor function, extending the reach of citizen-journalists to communicate images and opinion.

(4) Social media enables Internet-based real-time, interactive exchange of information. Social media applications enable PA professionals to interact with users, to become aware of misinformation and disinformation, and to accelerate dissemination of accurate information.

(5) All Internet-based information has the potential to be instantaneously shared globally – often a function of public interest.

## Section II Army Public Affairs Organizations

### 19-11. The Office of the Chief of Public Affairs

a. By Army General Order No. 2017-01, the SECARMY has assigned the Chief of Public Affairs with the responsibility to conduct PA operations.

b. As principle advisor to the SECARMY and Chief of Staff of the Army (CSA) on Army public communication policies and strategies, Chief of Public Affairs assesses, plans, conducts, and evaluates PA policies, and programs for the Army Active and Reserve components. The CPA—

(1) Serves as the proponent for all PA issues across doctrine, training, leader development, organization, materiel, Soldier / civilian support (DTLOMS) principle advisor to the SECARMY and CSA on Army support to US strategic communication.

(2) Manages the Army's Public Information Security Review Program.

(3) Manages the review and clearance of information for release outside DOD by the Office of the Secretary of the Army (OSA) and the Army staff (ARSTAF).

(4) Advises, assists, and provides direction to HQDA in developing and endorsing communication strategies, themes, and messages for internal and external audiences.

(5) Manages the OSA and ARSTAF PA program.

(6) Oversees the implementation of public law that authorizes Army special bands to produce recordings for commercial sale.

(7) Prescribes and monitors the level and nature of Army support to the annual conventions of conferences of national military associations.

(8) Approves HQDA level PA awards.

(9) Manages the Army's participant selection process for the DOD-sponsored Joint Civilian Orientation Conference.

(10) Coordinates with the Director of Information Systems for Command, Control, Communications and Computers (DISC4) visual information activity policy and authorizations including management procedures for continental US radio and television broadcast facilities and Internet policies.

(11) Processes PA policy exception requests.

(12) Processes requests for US Army Parachute Team (Golden Knight) demonstrations and approves the team's annual demonstration schedule.

(13) Processes requests for Army aerial activities in public events.

(14) Produces timely news, information and limited entertainment programming and distributing through ArNews ([www.army.mil](http://www.army.mil)) and Defense Media Activity.

### 19-12. Army Regional Public Affairs Offices

Three regional community outreach offices, organized under the Office of the Chief of Public Affairs, are manned with military and civilian PA professionals to assist with coordination with community and business leaders, media, sports teams, military and veteran service organizations, and other agencies and centers of influence. Specific expertise for book projects, TV / movie / documentary projects are described here.

a. OCPA Northeast, in New York City, provides DA-level PA support to 10 northeast region states, while representing Army leadership in the region by establishing, building, and maintaining liaisons with national news and entertainment media, civic leaders, centers of influence, and veterans' and military service organizations. This office also manages the Army Book Program and coordinates with civilian book authors for published works.

b. OCPA Midwest, in Chicago, provides DA-level PA support to 16 states of Midwest; builds and maintains liaisons with civic leaders, centers of influence, veterans' and military service organizations as well as national entertainment and media organizations throughout the Midwest.

c. OCPA West, in Los Angeles, provides DA-level PA support to the entire Army on entertainment media projects. Additionally, supports 13 western region states, by establishing, building, maintaining liaisons with national news and entertainment media, civic leaders, centers of influence, and veterans' and military service organizations.

### **19-13. Defense Public Affairs-Associated Agencies**

a. Defense Media Activity is the DOD agency that provides news and information to U.S. forces and families worldwide. The agency presents news, information and entertainment on a variety of media platforms, including radio, television, internet, print media and emerging media technologies.

b. Defense Information School is the joint-service training and education center for all U.S. DOD PA and visual information professionals.

c. Stars and Stripes Newspapers operate as mission-essential activities of the DOD and designated Unified Combatant Commands (CCMD). The Stars and Stripes newspapers operate with the editorial policies and practices of US commercial newspapers. The Stars and Stripes does not represent the official position of the US Government, including the DOD or the Unified CCMD. They are funded by sales, advertisements, and appropriated funds support.

### **19-14. Organic Public Affairs Sections**

PA sections are embedded in the headquarters of Army brigades, divisions, and echelons above division. These sections provide PA support to the command and serve as the commander's principal advisor on PA issues. Ranging from a single senior noncommissioned officer to a colonel with a small staff, these sections conduct PA planning and limited PA operations. PAOs are generally trained and educated in public-affairs specific knowledge and skills at the Defense Information School. Personnel and materiel constraints require these organic PA sections be augmented by SRC 45 units for most operations.

### **19-15. Army Command, Army Service Component Command, and Direct Reporting Unit Public Affairs Sections**

An Army Command (ACOM) PAO or Army Service Component Command (ASCC) PAO is a colonel serving on the commanding general's personal staff, responsible to the commander and to units attached, assigned or aligned to the Army, training for, mobilized, or deployed in support of combined or joint operations. The ASCC PA section coordinates closely with the PA sections of other government agencies, coalition commands, and other forces, when appropriate, to synchronize and conduct PA operations. Combatant command PA may direct the planning, priorities, and PA activities across the ASCC's operational area. The PA section is organized, staffed, trained, and equipped to deploy rapidly in support of theater Army-level operations and to direct PA activities in support of the commander's communication strategy. When deployed, the Army Headquarters PA staff will be augmented by a Press Camp Headquarters (PCH) or multiple Mobile Public Affairs Detachments (MPAD), and will assume all the missions and capabilities of that organization.

### **19-16. Corps and Division Public Affairs Sections**

The Corps PAO is a colonel and serves on the personal staff of the Corps commander. The Division PAO is a lieutenant colonel and serves on the personal staff of the division commander. The sections are organized, staffed, trained, and equipped to rapidly deploy in support of task force operations. The Corps and Division PA sections provide PA support to the Corps and Division commander respectively and to all assigned or attached units in support of national, multinational, unified, or joint operations. Corps and Division PAOs exercise planning and supervisory authority over all PA units attached, assigned or under the operational control of the respective headquarters. The PAOs coordinate closely with the organic PA sections of lower and adjacent commands, and other forces to carry out PA operations in support of the commander's PA operations. When deployed, both PA staffs may be augmented by an MPAD or a Public Affairs Detachment (PAD).

### **19-17. Brigade Combat Team and Multi-Functional / Functional Brigades Public Affairs Sections**

The Brigade Combat Team (BCT) PAO is a major and serves on the personal staff of the brigade commander. The staff section is organized, staffed, trained, and equipped to deploy rapidly in support of brigade task force operations. The BCT PA section coordinates closely with higher echelons and other forces to carry out PA operations. A multifunctional or functional brigade PA section is comprised of two trained PA Soldiers who serve on the special staff of the brigade commander. The multifunctional brigade PA is comprised of a PA sergeant first class (SFC) and a PA sergeant (SGT). The functional brigade PAO is a captain or PA SFC with one PA SGT. The PA staff sections support and receive

support from higher echelon PA staffs. When augmented by a PAD team, the PAD commander may serve as the brigade PAO when no organic PA officer is assigned or authorized.

### **19-18. United States Army Reserve and Army National Guard Component Public Affairs**

The vast majority of PA assets are in the United States (U.S.) Army Reserve (USAR) and Army National Guard (ARNG)—more than 65 percent of the total PA force and 85 percent of the deployable Table of Organization and Equipment (TOE) unit structures. These USAR and ARNG units and personnel must be seamlessly integrated with the active component and focused on supporting the overall Army goals and objectives. The four types of TOE PA organizations, predominately positioned in the USAR and ARNG, are discussed in the following paragraphs.

### **19-19. Public Affairs Standard Requirements Code 45 Units**

The U.S. Army is the only U.S. military service to have deployable PA units. There are four types of Standard Requirements Code (SRC) 45 units: PCH, MPAD, PAD, and Broadcast Operations Detachment (BOD). These units are designed to augment theater, corps, division, brigade, Special Forces Groups (Airborne), and other organic PA staff to support unified land operations. PA SRC 45 units are fully capable of operating in operational environments but require administrative and life support functions, such as field feeding and unit-level maintenance, from the supported command.

### **19-20. Press Camp Headquarters**

The PCH is the most capable SRC 45 unit in the inventory. The PCH is commanded by a lieutenant colonel and is modularly organized, staffed, trained, and equipped to rapidly deploy in support of military operations at the Division to Joint Forces Land Component Command (JFLCC) and Theater Army levels. The PCH is capable of directing and leading subordinate PA activities and units across the Area of Responsibility (AOR) / Joint Operations Area (JOA). The PCH is capable of performing all core PA tasks and has transportation and audio-visual equipment sufficient to produce radio, television, and print products for internal or external audiences, as well as resources to credential, brief, escort, and support visiting media. When deployed in support of Army, or joint service operations, a BOD and one to three MPADs will augment the PCH. The PCH most often collocates with and operates in support of the highest level of U.S. command within the theater or AOR.

### **19-21. Mobile Public Affairs Detachment**

The MPAD is commanded by a major, can be task organized into two or three teams, and is assigned to the theater, corps, division, or Joint Task Force (JTF) Headquarters (HQ) under the operational and tactical control of the senior PA officer or PCH commander. It is staffed, trained, and equipped to rapidly deploy in support of brigade, division, or corps-size task force operations. MPADs are assigned at a ratio of one per three brigade-size elements.

### **19-22. Public Affairs Detachment**

A PAD is commanded by a captain and comes with its own transportation and sufficient still and video equipment to produce print, radio, and television products for internal audiences. The PAD typically supports division or brigade-size task force operations. A PAD provides direct support to units in support of Army, combined, joint or coalition operations. Although it is primarily attached or assigned to a division, or a brigade, a PAD may support Special Forces Groups, civil affairs, and brigade equivalents. A PAD is modularly organized, staffed, trained, and equipped to deploy rapidly in support of operations. PADs may be divided into two teams to provide brigade-level support and augment the organic PA element or provide area support within the assigned command's AOR.

### **19-23. Broadcast Operations Detachment**

The BOD, is commanded by a major and consists of a command element, two broadcast teams, and a maintenance team. The only unit of its kind in DOD and the Army, a BOD operates 24-hours per day producing internal or external information products and sustaining broadcast stations and facilities. The BOD is designed to operate a mobile radio and television broadcast facility in support of Armed Forces Radio and Television Service operations, or to merge with other independent facilities to form a theater of operations network. A BOD performs as the broadcast support arm for a PCH, and produces broadcast products for distribution to internal and external worldwide publics through the Defense Media Activity

(DMA). The BOD is assigned to a theater army headquarters, joint task force, or combatant command when a PCH is assigned.

### Section III

#### Summary, Key Terms, and References

##### 19-24. Summary

a. Since the nation's founding, the Army has communicated information to the American people through the free and independent media, as an element of the public information program. Implicit in a democratic republic is the right of citizens to know about the activities of their elected government. The government, in return, has an obligation to inform its citizens about its activities. These rights also apply to the activities of the military, established by the Constitution, to provide for the common defense and general welfare of the U.S. One of the most significant conduits through which information is passed to the people is the free press guaranteed by the Constitution.

a. Today's information environment has made possible virtually instantaneous transmission of breaking news to world-wide publics. The American public is, as it always has been, interested in what happens to its sons and daughters in uniform, especially when they are executing operational missions. The increasing number, variety and complexity of real-world operations in which the U.S. Army has been involved has attracted considerable public and media interest and will continue to do so in the future. Commanders could conceivably win the battle and lose the information war by excluding, or attempting to exclude, media from operations or by overlooking the value of effective PA involvement throughout operational planning and execution.

##### 19-25. Key Terms

a. *Community Engagement.* Those public affairs activities that support the relationship between military and civilian communities, domestically and in military operations.

b. *Internal Information.* Communication by a military organization directed to the internal audience that creates an awareness of the organization's goals, informs them of significant developments affecting them and the organization, increases their effectiveness as ambassadors of the organization, and keeps them informed about what is going on in the organization. Formerly, called Command Information.

c. *Public Affairs.* Those internal information, public information, and community engagement activities directed toward both the external and internal publics with interest in the DOD.

d. *Public Affairs Guidance.* Constraints and restraints established by proper authority regarding public information, command information, and community relations activities. It may also address the method(s), timing, location, and other details governing the release of information to the public.

e. *Public Information.* Within public affairs, that information of a military nature, the dissemination of which is consistent with security and approved for release.

##### 19-26. References

- a. Army Regulation (AR) 25-55, The DA FOIA Program.
- b. AR 340-21, The Army Privacy Program.
- c. AR 360-1, The Army Public Affairs Program.
- d. DOD Directive (DODD) 5105.74, Defense Media Activity.
- e. DODD 5122.05, Assistant Secretary of Defense for Public Affairs (ASD(PA)).
- f. DODD 5122.11, Stars and Stripes Newspapers and Business Operations.
- g. DODD 5230-09, Clearance of DOD Information for Public Release.
- i. DODD 5400.07, DOD Freedom of Information Act Program.
- j. DODD 5400.11, DOD Privacy Program.
- k. DODD 5410.18, Public Affairs Community Relations Policy.
- l. DOD Instruction (DODI) 5410.19, PA Community Relations Policy Implementation.
- m. DOD 5120.4, DOD Newspapers, Magazines and Civilian Enterprise Publications.
- h. DODI 5230.29, Security and Policy Review of DOD Information for Public Release.
- n. DODI 5400.13, Public Affairs Operations.
- o. DODI 5400.14, Procedures for Joint PA Operations.



- p. DODI 5405.3, Development of Proposed PA Guidance.
- q. DODI 5410.15, DOD PA Assistance to Non-Government, Non-Entertainment-Oriented Print and Electronic Media.
- r. DODI 5410.16, DOD Assistance to Non-Government, Entertainment-Oriented Motion Picture, Television, and Video Productions.
- s. FM 3-13, Inform and Influence Activities.
- u. FM 3-61, Public Affairs Operations.
- v. JP 3-61, Public Affairs.

**This page is intentionally left blank**

## Chapter 20

### Defense Support of Civil Authorities

#### Section I

#### Introduction

##### 20-1. Chapter Content

This chapter discusses the interaction and cooperation between federal, state and local agencies in responding to official requests for support to provide relief in the event of man-made or natural disasters utilizing federal and state military resources.

##### 20-2. Defense Support of Civil Authorities Overview

a. The U.S. military primarily organizes, trains, equips, plans and conducts combat and stability operations. However, when requested by civil authority or directed by the President of the United States (POTUS), it also has enormous capability to rapidly respond and provide support to a wide variety of domestic emergencies and disasters. The Department of Defense (DOD) conducts these operations under civilian control and in accordance with the fundamental tenet of its professional ethos - subordination to civilian authority. Federal military forces normally respond in support of another federal agency, most often after a gubernatorial request to supplement the efforts and resources of state and local governments. Based on the U.S. form of government, and consistent with its historic experience, the military will not lead the federal response except for the most severe domestic emergency or disaster.

b. DOD Directive (DODD) 3025.18 defines DSCA as support provided by U.S. federal military forces; DOD civilians; DOD contract personnel; DOD component assets; and National Guard forces (when the Secretary of Defense (SECDEF), in coordination with the Governors of the affected states, elects and requests to use those forces in Title 10, U.S.C. status) in response to requests for assistance from civil authorities for domestic emergencies, law enforcement and other domestic activities, or from qualifying entities for special events.

##### 20-3. Constitutional and Policy Basis for Defense Support of Civil Authorities

a. Use of the military to support civil authorities stems from U.S. core national values as expressed in the Constitution which anticipates the use of federal military forces within U.S. borders. Article I, Section 8 states, "Congress shall have power... to provide for calling forth the Militia to execute laws of the Union, suppress Insurrections, and repel Invasions." Article II, Section 3 states POTUS, "...shall take care that the Laws be faithfully executed." The 10<sup>th</sup> Amendment provides the basis that federal government assistance, including DOD, is provided in support of State and local authorities. It reads in part, "The powers not delegated to the U.S. by the Constitution, nor prohibited by it, are reserved to the States respectively."

b. The 2015 National Security Strategy (NSS) identifies national interests such as the security of the United States (and) its citizens and strategic risks such as a catastrophic attack on the US homeland or critical infrastructure.

c. In February, 2013, DOD published its most recent Strategy for Homeland Defense and Defense Support of Civil Authority. All these strategies recognize that America's military may respond to a variety of national needs other than waging war and DSCA contributes significantly to satisfying America's national security requirements.

### 20-4. Historic Context for Domestic Military Support

a. Since America's inception, the Army has supported civil authorities in times of need. Floods, riots, hurricanes, earthquakes, and wildfires are all examples of situations that have caused states to deploy the National Guard and occasionally request the assistance of federal armed forces. Achieving national goals with regard to terrorism, WMD and illegal drug trafficking have also led to supplementing civilian efforts with military forces.

b. When America's Founding Fathers met to draft the U.S. Constitution in Philadelphia in 1787, Shay's Rebellion was a recent memory and insurrection a concern. To protect the viability of government, they created mechanisms to suppress rebellions or insurrections and enforce the law. The 1794 Whiskey Rebellion led to the fundamental precept, codified in current law that the military is in support of civil authority. A taxpayer revolt and increasing violence led to a Presidential response and deployment of federalized militia. Throughout this threat to federal governance, President Washington's guidance was that the military was to support local magistrates, not pre-empt them, and this principle remains the foundation of DSCA law, policy and processes.

c. Significant with regard to current law and policy is the April 1995 domestic terrorist attack on the Alfred P. Murrah Building in Oklahoma City. In the wake of that attack, President Clinton issued Presidential Decision Directives (PDD) 39 and 62 that clarified the roles and missions of various federal agencies with regard to countering and combating terrorism. These documents defined terms such as: Crisis Response Management (CrM), Consequence Management (CM), and Lead Federal Agency (LFA) that have since been given new meaning by more recent documents, particularly Presidential Policy Directive 8 (PPD-8), National Preparedness.

d. Current disaster response organizations, systems and processes evolved from the civil defense mission of the U.S. Army Continental Army Command (CONARC), which was inactivated in 1973. President Carter's 1979 Executive Order 12148 established the Federal Emergency Management Agency (FEMA) and transferred many of the missions formerly performed by CONARC to FEMA. The 1988 Stafford Disaster Relief and Emergency Assistance Act and Executive Order 12656 that delegated most of the President's Stafford Act authority to the FEMA Director were instrumental in establishing current interagency responsibilities. The military also has a history ensuring the continuity of government in the event of a national emergency and EO 12656 identified agency responsibility and refined those processes as well.

e. In the wake of the September 2001 terrorist attacks, Hurricane Katrina in 2005, and Hurricane Sandy in 2012, the U.S. remains in another period of evolving change with regard to how the military supports civil authority. DOD's Executive and Action Agent responsibilities moved from the Army to the Office of the Secretary of Defense (OSD) and the Joint Staff (JS) respectively. HSPD-5 Homeland Security, and the subsequent PPD-8, directed alignment of federal, state and local coordinating structures, capabilities and processes into a unified, all-discipline, all-hazards approach to domestic incident management. HSPD-5 integrated CrM and CM, recognizing that all agencies responding to a disaster or emergency do so while retaining their own authorities and responsibilities under law and policy.

### 20-5. Department of Defense Role in Homeland Security Today

a. The 2002 National Strategy for Homeland Security (NSHS) defined Homeland Security (HS) as "a concerted national effort to prevent terrorist attacks within the U.S., reduce America's vulnerability to terrorism, and minimize damage and recover from attacks that do occur." In the wake of Hurricane Katrina, many observers expected the next NSHS to expand the definition of HS to include natural and other manmade disasters. However, recognizing the unprecedented threat to national security posed by Chemical, Biological, Radiological, Nuclear and High-Yield Explosive (CBRNE) and Weapons of Mass Destruction (WMD), the 2007 NSHS definition was unchanged, remaining focused on terrorism. In the decade since September 11, 2001, this clear and present threat to the homeland has resulted in dramatic change to DOD's HS culture and capabilities, particularly the CS or DSCA mission. As DOD continues to contribute through its military missions overseas and HS efforts, the pace of change has slowed, although the mission set continues to evolve.

b. The 2013 DOD Strategy for HD and CS identifies two broad mission areas: HD and CS, and DSCA. The DOD Strategy uses a "lead, support or enable" construct to categorize DOD's activities to secure the

U.S. from direct attack. DOD has lead responsibility for HD and is the primary federal agency for this mission. HD is DOD's primary responsibility and is defined as the protection of U.S. sovereignty, territory, domestic population, and critical defense infrastructure against external threats and aggression, or other threats as directed by POTUS. This chapter does not deal with HD and CS, only DSCA.

c. DOD has had a reluctance to take on the CS mission, considering it a mission to accept only when resources were available to assist. Perhaps the most significant change for DOD today is that with the unprecedented threat to the U.S. homeland, DOD must be able to conduct CBRN CM as an integrated part of national security efforts. For the first time, the 2008 National Defense Authorization Act (NDAA) directed DOD to budget for this mission and this chapter will explain how DOD is spending resources to evolve its DSCA role.

d. Also associated with DOD's HS construct is Mission Assurance (MA) which includes activities to ensure DOD support of the POTUS and SECDEF during a national security emergency. MA has traditionally been described as providing a foundation for both HD and DSCA by supporting national continuity of government (COG) and continuity of operations (COOP) programs designed to ensure Enduring Constitutional Government (ECG). At the federal level, COG is a coordinated effort within each branch of government to ensure capability to continue minimum essential functions in a crisis; COOP are internal efforts within various governmental departments, agencies and organizations to ensure capability to continue operations in support COG and ECG.

e. The role of DoD in Cyberspace, as related to Homeland Defense and Defense Support to Civil Authorities, continues to evolve since the September 2010 Memorandum of Agreement between DHS and DoD discussed the groundwork for mutual support.

## 20-6. Defense Support to Civil Authorities Principles

a. DOD almost always provides DSCA when requested by civil authorities and approved by the SECDEF. DOD can also provide support when directed by POTUS or SECDEF, or when authorized under separate established authorities.

b. DOD remains in support of civil authority and generally in support of a primary federal agency.

c. The DOD Strategy for HD and CS (2005) reaffirms that protecting the U.S. from attack is DOD's highest priority. Unless otherwise directed by the SECDEF, on-going military or HD missions have priority over DSCA missions.

d. DOD provides DSCA in accordance with applicable laws, Presidential Directives, Executive Orders and DOD policy with absolute, public accountability of officials involved in the oversight of DSCA processes and while maintaining our constitutional principles and civil liberties.

e. As a general rule, civil resources are used first, and DSCA is generally provided only when requirements exceed the capabilities of civil authority as determined by FEMA or another federal agency with primary responsibility. DSCA emphasizes DOD's unique skills and structures, and should be limited in scope and duration. DoD advocates that they are the resource of last resort and usually the most expensive option.

f. DOD usually provides DSCA through designated federal agencies using established agreements and plans, guided by civilian law and the principle that the federal government assists state agencies, except in terrorism and other incidents where the federal government has primary jurisdiction.

g. DOD Components do not procure or maintain supplies, materiel or equipment exclusively for providing DSCA unless set forth in law or directed by the SECDEF.

h. Military forces remain under military mission command and the authority of the DOD Executive Agent at all times.

i. DOD components do not perform any function of civil government unless absolutely necessary, and then only on a temporary basis.

j. While there are exceptions, DSCA is provided on a cost reimbursable basis, primarily through the Stafford Act for Presidentially declared disasters or the Economy Act for other situations. Only the SECDEF and POTUS are authorized to grant a reimbursement waiver.

### 20-7. Defense Support of Civil Authorities Mission Sets

The DSCA environment is so complex and dynamic that it is difficult to clearly and consistently create simple categories of missions. The categories used by Joint Publication JP 3-28 Defense Support to Civil Authorities used here are different than Army Doctrine Reference Publication ADRP 3-28, but are complementary and may be in effect simultaneously. Subsequent sections explain the categories and describe many, but not all, of the various mission sets DOD could be called on to support.

a. Supporting an all-hazards response. Disasters and declared emergencies will likely be Presidentially declared. In fact, most instances of local commanders invoking immediate response authority are in this category. Disasters and emergencies can be natural or manmade. Examples include: natural disasters (flood, blizzard, earthquake, etc.); wildfire suppression; and CBRN consequence management.

b. Supporting civilian law enforcement agencies. Restoring public health and services and civil order includes CDO and support in the event of strikes or work stoppage by public service employees (e.g., 1981 air traffic controller strike). It also includes Presidentially-directed critical infrastructure protection. If not a declared emergency, this category also includes mass immigration emergencies, border security, and animal disease eradication.

c. Other domestic activities and special events. Special events encompass any recurring or unique event identified by the Department of Homeland Security (DHS) Special Events Working Group that warrants defense support. Examples include the Olympics, Super Bowls, and the World Series. National Special Security Events (NSSE) are a sub-category of such magnitude or importance that the Secretary of HS designates them an NSSE. The U.S. Secret Service assumes responsibility for the security planning and execution. Recent examples include Presidential Inaugurations, Papal Visits, Democratic and Republican National Conventions, and State Funerals. Periodic planned support is a wide ranging category of support to civil authorities that routinely takes place to enhance civil-military relations and meet the needs of local communities, states and even other federal agencies.

## Section II Domestic Emergency Management Environment

### 20-8. National Incident Management

a. Tiered Response. One of the most important DSCA concepts is that the U.S. has traditionally used a “bottom-up” as opposed to a “top-down” approach to emergency management with three tiers of support—local, state and federal. Primary responsibility for responding to domestic disasters and emergencies rests with the lowest level of government able to effectively deal with the incident. If a situation exceeds local capability, local authorities are generally expected to seek assistance from neighboring jurisdictions under a mutual aid agreement before requesting state assistance. Similarly, if a state’s capability proves insufficient, state authorities ask for assistance, to include non-federalized National Guard, from other states under existing agreements and compacts before requesting federal assistance. In the event of a very large or catastrophic event, federal aid may be provided while mutual aid agreements and compacts are still being coordinated. Defense resources are provided when circumstances warrant; military support can be provided at state (National Guard forces under state control) and federal level. Although not a designated tier of support or a level of elected authority, regional response both within a state and among states is increasingly important.

b. Key National Response Documents. The National Incident Management System (NIMS) and National Response Framework (NRF) provide a single, comprehensive, nation-wide approach to incident management. The NIMS provides an action template for incident management. The NRF provides the policy structure and mechanisms for national-level policy for incident management and can be considered a framework for integrating federal support into state and local government efforts.

(1) Updated in October, 2017, NIMS establishes a core set of concepts, principles, terminology and organizational processes to enable effective, efficient and collaborative incident management for federal, state, local and tribal governments, nongovernmental organizations and the private-sector. Responding agencies retain all their jurisdictional authorities and responsibilities, and they maintain operational control

of their functions. Thus, another critical DSCA concept is that domestic emergency management operations are much more about unity of effort than about unity of command.

(2) The NRF is a guide to how the Nation responds to all types of disasters and emergencies. It is built on scalable, flexible, and adaptable concepts identified in the NIMS to align key roles and responsibilities across the Nation. This Framework describes specific authorities and best practices for managing incidents that range from the serious but purely local to large-scale terrorist attacks or catastrophic natural disasters. The NRF describes the principles, roles and responsibilities, and coordinating structures for delivering the core capabilities required to respond to an incident and further describes how response efforts integrate with those of the other mission areas.

(a) The NRF applies to all incidents requiring a coordinated federal response in concert with state, local, tribal, private-sector, and nongovernmental entities. The NRF is applicable to all federal departments and agencies that participate in a coordinated federal response. The NRF also applies to the non-governmental responders such as the American Red Cross and National Voluntary Organizations Active in Disaster (NVOAD).

(b) The NRF is always in effect although the selective implementation of various elements allows flexibility to meet the unique requirements of any situation. It enables effective interaction among federal, state, local, tribal, private-sector, and other nongovernmental entities.

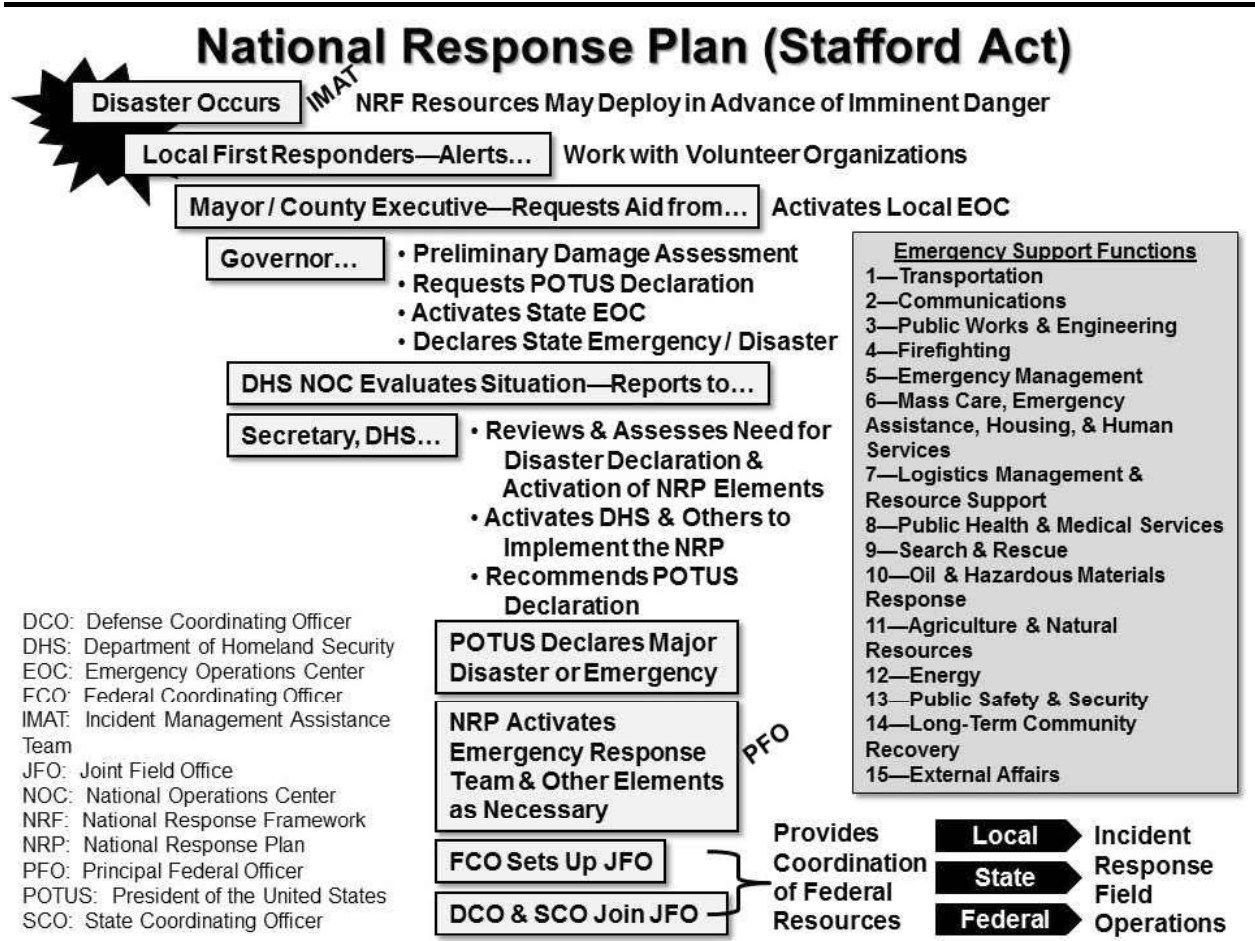

Figure 20-1. National Response Plan (Stafford Act)

(c) There are two broad categories of federal assistance for disasters and emergencies. The Robert T. Stafford Disaster Assistance and Emergency Relief Act provides the authority for coordinating federal responses to most disasters. Figure 20-1 provides a schematic of initial federal involvement under the Stafford Act. Figure 20-2 provides a diagrammatic overview of federal-to-federal support in non-Stafford Act situations.



### 20-9. Local Response

a. In the immediate aftermath of a disaster, local responders will arrive first on the scene. First responders normally include law enforcement, fire, emergency medical services (EMS), and HAZMAT teams. At the incident site, local authorities organize the various responders under the Incident Command System (ICS), a major component of the NIMS. Military forces conducting DSCA will interact with and be a part of an ICS structure.

b. Incident Command System. NIMS establishes ICS as the standardized organizational structure for the management of all domestic incidents, yet ICS provides more than just structure. ICS characteristics include: common terminology; modular organization; management by objective; reliance on an incident action plan; manageable span of control; and integrated communications. Within the ICS, there are five major functional areas; command, operations, logistics, planning, and finance. Traditionally, information and intelligence functions are located in the planning section; however, if the situation warrants, NIMS ICS can separate intelligence out and add a sixth functional area. An ICS hallmark is the flexibility to accommodate all circumstances including floods, hazardous material accidents, aircraft crashes, and



earthquakes—it is an all-hazard system. Flexible enough to manage catastrophic incidents involving thousands of response personnel, several levels of command are possible:

(1) A single command structure provides one commander a reasonable span of control. The incident commander is normally the senior responder of the organization with the responsibility for the event, (e.g., fire chief or police chief). The single incident commander establishes an incident command post to direct operations.

(2) Unified Command (UC). ICS has the flexibility for one or more agencies to coordinate and combine independent efforts should the situation dictate. ICS can transition from a single Incident Commander (IC) to a UC structure to enable agencies with different legal, geographic and functional responsibilities to coordinate, plan and interact effectively. In a UC structure, the individuals designated by their jurisdictional authorities jointly determine objectives, plans, and priorities and work together to execute them. UC as used by NIMS ICS is where the aforementioned unity of effort is manifested as all responding agencies and organizations work to support the IC without giving up individual agency authorities, responsibilities or accountability. An incident large enough to require DOD support will almost certainly be multi-jurisdictional UC.

(3) Area Command is established either to oversee the management of multiple incidents being handled by separate ICS organizations or to oversee the management of a very large incident that involves multiple ICS organizations. Area Command is activated only if necessary, depending on the complexity of the incident and span-of-control considerations. Area Command does not have operational responsibilities. Functions include: setting priorities; allocating resources according to established priorities; ensuring effective communications; ensuring that incident management objectives are met and do not conflict with each other or with policy.

c. To supplement their capabilities, local governments establish mutual aid agreements with surrounding communities. They are usually activated before local authorities request state assistance.

## 20-10. State Support

a. State Governors are empowered to execute the laws of their states. They are the Commanders in Chiefs of the state National Guard when serving in State Active Duty (SAD or Title 32) status. Similar authorities are given to the governors of U.S. territories and possessions. Once a disaster occurs, the Governor decides whether to honor a local government Request for Assistance (RFA) and, if appropriate, declares a state of emergency, activates the state response plan and calls up the National Guard under state orders. The Governor informs the FEMA regional director of these actions and when state resources are insufficient, requests federal assistance.

b. State Office of Emergency Services (OES). All states have an agency that coordinates and conducts emergency preparedness planning, training and exercises, and serves as the coordinating agency for the Governor in an emergency. The titles of these offices vary from state to state (e.g., Emergency Management Agency, Department of Public Safety, State Emergency Management Office, and Office of Emergency Preparedness). The OES is generally organized as a standalone office under the Governor, aligned under The Adjutant General (TAG) or the state police. The senior official in charge of OES varies by state. Some states have a separate Director of Emergency Services and Director of HS. Some states combine the positions and some states dual-hat their TAG as the Director of Emergency Services.

c. State National Guard forces are particularly well-suited to provide military support to local and state agencies. The National Guard in state status is the primary military responder during natural or man-made disasters and emergencies. It is familiar with local conditions and geography, and acting as a state militia, is not constrained by limitations on federal troops, principally the Posse Comitatus Act.

(1) The National Guard operates under one of three statuses: state status (state funding and state control); Title 32 status (federal funding and state control); or Title 10 status (federal funding and federal control). State CS missions are authorized by executive order of the Governor who reimburses the federal government for utilization of federal equipment and facilities. Employment of National Guard assets by the Governor is in accordance with state laws and constitutions.

(2) The State National Guard Joint Force Headquarters (JFHQ) organizes, trains, plans, and coordinates the mobilization of National Guard units and elements for state and federal missions. Deployment and employment of the State National Guard is directed through the JFHQ.

d. In times of emergency, states often call on other states for help through standing agreements or emergency assistance compacts.

(1) The largest agreement is the Emergency Management Assistance Compact (EMAC). The EMAC expedites the employment of interstate emergency response assets and may involve all types of support to include National Guard forces. Assets provided by another state are under control of the Governor of the requesting state while assistance is being provided. Units especially suited to provide support for 'predictable' disasters, such as annual wildfires of hurricanes, are pre-arranged during annual EMAC conferences, greatly reducing response times.

(2) Requests for EMAC assistance are legally binding, contractual arrangements requiring the states requesting assistance to reimburse out-of-state costs for out-of-state personnel.

### Section III

#### Federal Role in the National Response Process

##### 20-11. Primary Federal Departments and Agencies

a. Secretary of HS, DHS & FEMA. Pursuant to HSPD-5, the Secretary of HS is the principal federal official for domestic incident management within the U.S. to prepare for, respond to, and recover from terrorist attacks, major disasters and other emergencies. Acting through FEMA, the Secretary has responsibility to effectively manage federal response and recovery efforts. FEMA also initiates proactive mitigation activities, trains first responders, and manages the National Flood Insurance Program. FEMA Headquarters is in Washington, DC. There are ten regional offices, three logistics centers, two training centers and other special purpose sites.

b. Attorney General of the U.S., Department of Justice (DOJ), & Federal Bureau of Investigation (FBI). Pursuant to HSPD-5, the Attorney General has responsibility for criminal investigations of terrorist acts or threats inside the U.S., or directed at U.S. citizens or institutions abroad, where such acts are within the federal criminal jurisdiction of the U.S. He is also responsible for related intelligence collection within the U.S. subject to the National Security Act of 1947, other applicable laws and Executive Order 12333. Generally acting through the FBI, the Attorney General, in cooperation with other federal departments and agencies, coordinates the law enforcement activities to detect, prevent, preempt, and disrupt terrorist attacks against the U.S.

c. DOD. Understanding that DOD has significant resources that might be available to support federal domestic incident management efforts, HSPD-5 states, "The SECDEF shall provide military support to civil authorities for domestic incidents as directed by POTUS or when consistent with military readiness and appropriate under the circumstances and the law. The SECDEF shall retain command of military forces providing civil support."

d. Other Primary Departments and Agencies. Many of the federal agencies DOD could support, or with whom a habitual relationship exists during a DSCA event, are codified in the NRP's Emergency Support Function (ESF) framework (Table 20-1).

##### 20-12. Federal Structure for National Response Force Response and Recovery

a. The Regional Response Coordination Center (RRCC), located in each of the ten FEMA regions, is a standing facility operated by DHS/FEMA that coordinates regional response efforts, establishes federal priorities, and when disaster strikes, coordinates federal support until a Joint Field Office (JFO) is established. The RRCC establishes communications with affected State Emergency Operations Centers (EOCs) and the DHS National Operations Center (NOC). FEMA and interagency representatives staff the RRCC as needed.

b. A Joint Field Office (JFO) is a temporary federal facility established in a disaster area to provide a central point for federal, state and local executives to coordinate their actions. Although the JFO uses an ICS structure and adapts to the magnitude of the situation, it does not manage on-scene operations.

---

Instead, it focuses on providing support to on-scene efforts and conducting broader support operations that may extend beyond the incident site. When incidents impact multiple states or localities, multiple JFOs may be established. Using NIMS ICS principles of UC, JFO activities are directed by a JFO Coordination Group which may include the following officials:

(1) A Principal Federal Official (PFO) is personally designated by the Secretary of HS as a representative locally to oversee, coordinate and execute the Secretary's incident management responsibilities. The NRF states the PFO does not replace the incident command structure and does not have directive authority over the Federal Coordinating Officer (FCO) or the Senior Federal Law Enforcement Officer (SFLEO). The Secretary will designate a PFO only for complex, high-visibility catastrophic disasters, terrorist events or complex emergencies with significant national impact.

(2) FCO manages and coordinates the overall federal response and recovery activities for Stafford Act disasters and emergencies. The FCO is head of the JFO and works in partnership with the State Coordinating Officer (SCO) to determine and satisfy state and local support requirements. The FCO coordinates and tasks federal departments and agencies as required.

(3) Federal Resource Coordinator (FRC). In non-Stafford Act situations when a federal department or agency acting under its own authority requests DHS assistance to obtain support from other federal departments and agencies, DHS designates a FRC instead of an FCO. In these situations, the FRC coordinates support through interagency agreements and memorandums of understanding.

(4) Senior Federal Law Enforcement Officer (SFLEO) is the senior law enforcement official from the agency with primary jurisdictional responsibility. The SFLEO directs intelligence and investigative law enforcement operations and supports the law enforcement component of the UC on scene. In the event of a terrorist incident, this official will normally be the FBI Special Agent in Charge (SAC).

(5) Officials representing other federal departments or agencies with primary statutory responsibility for certain aspects of incident management are Senior Federal Officials (SFO). SFOs employ existing authorities, expertise and capabilities in coordination with the PFO, FCO, SFLEO and other members of the JFO Coordination Group.

(6) SCO manages the state's incident management activities and is counterpart to the FCO. Another important official is the Governor's Authorized Representative (GAR). The JFO Coordination Group may also include tribal/local area representatives with primary statutory authority for incident management.

(7) The GAR provides executive oversight and direction of the disaster or emergency response and recovery on behalf of the Governor, executes all necessary documents on behalf of the state, and responds to the desires of the Governor.

(8) The Defense Coordinating Officer (DCO), typically an Army O6, represents DOD as the single point of contact, except for ESF #3, Public Works & Engineering, in the JFO. In this capacity, the DCO reporting chain remains through U.S. Northern Command (USNORTHCOM) but the DCO responds to the FCO. The DCO is responsible for validating all requests for DOD support from the FCO or his representative.

c. The NRF organizes emergency response into 15 Emergency Support Functions (ESF) according to the capabilities and resources most likely to be requested by state officials. ESFs are the primary means through which the federal government provides assistance during a disaster or emergency. DOD is more active in response as opposed to recovery.

(1) During an emergency, some or all of the ESF may be activated based on the nature and scope of the event and the level of federal resources required.

(2) DOD is the Primary Coordinating Agency for ESF #3 (Public Works and Engineering), with the U.S. Army Corps of Engineers (USACE) as the DOD lead. DOD is considered a support agency to all ESFs.

(3) DOD, DSCA, Automated Support System (DDASS) is utilized to manage, collaborate, coordinate, and prioritize FEMA Mission Assignments (MA) assigned to the DOD in real time. It provides the means for a Defense Coordinating Unit (DCU), one assigned to each FEMA region, to validate MAs and allow all Orders, Request for Forces (RFF) and FEMA MA forms to be associated with specific missions and provide multiple command situational awareness to view and respond to mission critical actions.

d. FEMA's four Federal Interagency Operational Plans (FIOPs); Protection, Response, Recovery and Mitigation, greatly updated and expanded in 2016, provide a detailed description of roles and responsibilities, specifies the critical tasks, and identifies Federal resourcing requirements for delivering

national preparedness core capabilities for each of the four mission areas. Incident-specific annexes, such as the Nuclear/Radiological Incident Annex to the Response and Recovery Federal Interagency Operational Plans, explores likely disaster scenarios to a high fidelity to assist planners and exercise designers.

### **20-13. Promoting Federal-State Unity of Effort**

a. Unity of effort between the federal government and states must be one of DOD's guiding principles in the homeland, since unifying DOD's efforts with those of its external partners improves collaboration and shortens response times for meeting life-saving needs during emergencies. The Council of Governors—established by Executive Order in 2010—is an essential forum for enhanced, senior-level dialogue among federal and state civilian and military officials for this purpose.

b. As DOD seeks a closer and more highly coordinated relationship between federal and state military disaster response elements, it prioritizes these capabilities and activities to achieve unity of effort in the period covered by this strategy.

c. Trained and certified dual status commanders. DOD regards dual status commanders as the usual and customary Command and Control (C2) arrangement in cases where federal military and state National Guard forces are employed simultaneously in support of civil authorities within the U.S.

(1) POTUS may authorize a National Guard officer of a state or a commissioned officer of the Regular Army or the Regular Air Force to serve as a dual status commander, with the consent of the applicable state or territorial Governor. The dual status commander has authority over both state military forces (e.g., National Guard forces in a SAD or Title 32 status) and federal military forces. When a commander is in dual status (e.g., Title 10 and Title 32), the governor recommends and the POTUS approves this individual being a dual status. The purpose of this status is so the commander can command, control, and coordinate all resources that are either federal or state. This authority allows the commander to coordinate and de-conflict federal and state operational assignments while respecting the state and federal chains of command.

(2) Historic examples of the employment of dual status commanders include national special security events such as the Democratic and Republican national conventions and responses to disasters like Hurricane Sandy and wildfires in the Western U.S.

### **20-14. Emergency Support Function—3 (Public Works and Engineering)**

a. USACE's long history of providing CS for flood control, water quality, and hazard mitigation under Public Law 84-99 make it the logical organization to serve as primary agency for ESF-3, Public Works and Engineering. The geographically dispersed location of USACE offices facilitates timely response to disasters in almost any area. The USACE is divided by watershed drainage basins into regional divisions that are subdivided by smaller drainage basins into districts. Personnel are also assigned to various field offices throughout each district. During disasters, USACE personnel quickly mobilize to assist in response and recovery.

b. Each USACE division and district has an emergency operations manager and each office develops plans based on hazards unique to its area, coordinates with appropriate agencies, and identifies response teams to support the assigned missions in the NRF. Types of assistance provided by USACE under ESF #3 include: technical advice and evaluations; engineering services; construction management and inspection; emergency contracting; emergency repair of wastewater and solid waste facilities; real estate support. Some ESF-3 activities include emergency debris clearance; restoration of critical public services and facilities, including supply of adequate amounts of ice and potable water; temporary restoration of water supply systems; technical assistance; structural evaluation of buildings; and damage assessment. By law, USACE assistance is limited to the preservation of life and protection of residential and commercial developments, to include public and private facilities that provide public services. Exclusive assistance to individual homeowners and businesses, including agricultural businesses, is not authorized. However, during periods of extreme drought, assistance may be provided to farmers and ranchers under some circumstances.

**Table 20-1. Federal Response Plan Emergency Support Functions**

	Responsibility	ESF Coordinator
ESF 1: Transportation	Provide civilian & military transportation support	Department of Transportation
ESF 2: Communications	Provide telecommunications support	DHS, National Communications System
ESF 3: Public Works and Engineering	Restore essential public services & facilities	DOD, U.S. Army Corps of Engineers
ESF 4: Fire Fighting	Detect and suppress wild land, rural & urban fires.	Department of Agriculture, U.S. Forest Service
ESF 5: Information Planning	Support overall federal activities for domestic Incident Management	DHS, FEMA
ESF 6: Mass Care, Emergency Assistance, Housing & Human Services	Manage and coordinate food, shelter and first aid for victims; provide bulk distribution of relief supplies; operate a system to assist family reunification.	DHS, FEMA
ESF 7: Logistics Management & Resource Support	Provide equipment, materials, supplies and personnel to federal entities during response	General Services Administration (GSA) and DHS, FEMA
ESF 8: Public Health & Medical Services	Provide assistance for public health and medical care needs	Department of Health and Human Services (HHS)
ESF 9: Search and Rescue	Locate, extricate and provide initial medical treatment to victims trapped in collapsed structures.	DHS, FEMA
ESF 10: Oil & Hazardous Materials Response	Support federal response to actual or potential releases of oil and hazardous materials	Environmental Protection Agency (EPA)
ESF 11: Agriculture & Natural Resources	Provides nutrition assistance, assurance of food safety and food security, control and eradication of devastating animal disease or plant pest infestation	Department of Agriculture
ESF 12: Energy	Restore power systems and fuel supplies.	Department of Energy
ESF 13: Public Safety & Security	Provide non-investigative/non-criminal law enforcement, safety and security capabilities	DOJ
ESF 14: Long Term Community Recovery	Provides a framework for federal support to enable community recovery from the long-term consequences of Incidents of National Significance	DHS, FEMA
ESF 15: External Affairs	Provide public affairs, community relations, Congressional affairs, state & local coordination	DHS, FEMA

c. Each FEMA regional office is responsible for maintaining an Incident Management Assistance Team (IMAT) and developing appropriate procedures for its notification and deployment. Composed of staff from FEMA and other agencies, it provides administrative, logistical, and operational support to the regional response activities in the field. Likely the first federal response element to arrive in a disaster

area, the IMAT can form the core of the Joint Field Office (JFO) once it is established. It also provides support for the dissemination of information to the media, Congress, and the public.

d. There are numerous other federal special teams available to support incident management and domestic response and recovery to include:

- (1) Hurricane Liaison Team (HLT)
- (2) Mobile Emergency Response Support (MERS)
- (3) DHS Situational Awareness Team (DSAT)
- (4) Damage assessment teams
- (5) Federal Incident Response Support Teams (FIRSTs)
- (6) Nuclear Incident Response Team (NIRT)
- (7) Disaster Medical Assistance Teams (DMATs)
- (8) HHS Secretary's Emergency Response Team
- (9) DOL/OSHA's Specialized Response Teams
- (10) Veterinarian Medical Assistance Teams (VMATs)
- (11) Disaster Mortuary Operational Response Teams (DMORTs)
- (12) National Medical Response Teams (NMRTs)
- (13) Scientific and Technical Advisory and Response Teams (STARTs)
- (14) Donation Coordination Teams
- (15) Urban Search and Rescue (US&R) task forces
- (16) Federal Type 1 and Type 2 Incident Management Teams
- (17) Domestic Emergency Support Team
- (18) Domestic Animal and Wildlife Emergency Response Teams and mitigation assessment teams

### **20-15. Defense Support of Civil Authorities Structure**

Combatant Commands (CCMD) serve as the DOD principal planning agents and supported organizations for geographic areas designated in the Unified Command Plan (UCP). They validate requests for military assistance in their Areas of Responsibility (AOR) and provide DSCA. There are two CCMDs with responsibility for parts of the U.S. homeland.

a. USNORTHCOM is responsible for planning, organizing, and executing all aspects of HD and performing DSCA missions within the continental U.S., Alaska and territorial waters, including Puerto Rico and the U.S. Virgin Islands. USNORTHCOM has few permanently assigned forces but will have authority over forces necessary to execute missions directed by POTUS or SECDEF.

b. USPACOM is responsible for the Indo-Asia-Pacific region and is responsible for all aspects of HD and DSCA on US territory in that region.

c. U.S. Army Forces North (USARNORTH), Fifth U.S. Army, located at Fort Sam Houston, Texas provides USNORTHCOM with a dedicated Army Service Component Command (ASCC) for HD.

(1) There are ten Defense Coordinating Officers (DCO) permanently assigned to USARNORTH. When not deployed, DCOs are assigned to USARNORTH with duty in one of the ten FEMA Regions.

(2) Defense Coordinating Element (DCE). The DCE is manned by military and civilian personnel and functions as the DCO's staff. The DCE optimally contains a small Active Duty / DA Civilian team, and representatives from the Army Reserve, Air Force Reserve, Marine Forces Reserve and the Coast Guard Reserve.

(3) Each state, territory, and FEMA region has assigned Reserve officers, typically O-6s, from the Air Force, Army, Navy, and Marines who are trained in disaster preparedness and military support matters. There are over 425 Emergency Preparedness Liaison Officers (EPLO); Regional Emergency Preparedness Liaison Officers (REPLO), or State EPLOs (SEPLO) assigned nationwide. They have a comprehensive knowledge of their service facilities and capabilities within their assigned area. SEPLOs assist in determining what DOD resources exist within the state, territory, or region and assist in coordinating the Title 10 response. SEPLOs typically report to their respective State EOC or National Guard EOC during a response and represent the DCO.

## Section IV Defense Support Process

### 20-16. Planning Considerations

Paragraph 20-5 described DOD's Philosophical DSCA Principles and these principles become the basis for planning and executing DSCA missions. Some additional considerations follow:

- a. National Guard forces serving on SAD status have primary responsibility for providing military assistance to state and local authorities in emergencies. DSCA planning and execution must foster a close and continuous coordination with the National Guard to ensure unity of effort.
- b. Army Reserve forces have extensive capability often located close to a disaster. IAW 12304a NDAA of 2012, when a governor requests federal assistance in responding to a major disaster or emergency, the SECDEF may, without the consent of the member affected, order any unit of the Army Reserve, Navy Reserve, Marine Corps Reserve, and Air Force Reserve to active duty for a continuous period of not more than 120 days to respond to the Governor's request. A Dual Status (Title10/32) Commander is typically appointed to direct the force's efforts in these instances.
- c. Military support will generally be of short duration (generally not exceeding 30 days) to assist civil agencies with establishing essential safety and security.
- d. The termination of DSCA and disengagement of DOD resources is a sensitive topic that requires planning consideration from the beginning.
- e. Rules of the Use of Force (RUF) serve essentially the same purpose for domestic operations that Rules of Engagement (ROE) serve overseas. CJCS Instruction (CJCSI) 3121.01B provides standing RUF. These RUF do not apply to National Guard forces in SAD or Title 32 status.
- f. Military intelligence assets are prohibited from engaging in intelligence collection activities against U.S. persons (with very limited exceptions clearly specified in law and Executive Order 12333). While there are legal provisions allowing for the use of defense intelligence collection resources in support of domestic incident management, DSCA planners need to be particularly sensitive to statutory limitations on the use of such resources.
- g. Defense Planning and Coordination (DPC) is a proposed concept to make use of existing DOD DSCA planning and liaison assets as an effective mechanism for supporting state and federal disaster planning and coordination.

### 20-17. Defense Support of Civil Authorities Request for Assistance Process

DoD provides its disaster and emergency support of FEMA in response to approved FEMA Mission Assignments (MAs). Most FEMA MAs are generated at the FEMA regional offices or joint field offices based upon requests from State and local officials. Some FEMA MAs are generated at the national level and normally are employed when FEMA is attempting to pre-position capabilities in advance of State and local needs. As much as possible, Pre-Scripted Mission Assignments (PSMAs) are used to develop FEMA MAs. PSMAs are typically groups of units and capabilities that function best when teamed together. PSMAs may be scaled to meet any given need.

- a. FEMA MAs From a Federal Coordinating Officer (FCO) (FEMA Regions or Joint Field Office (JFO)).
  - (1) The FCO presents a FEMA MA to the DCO.
  - (2) The DCO validates the MA using criteria in DoDD 3025.18, including:
    - (a) Legality (compliance with laws).
    - (b) Lethality (potential use of lethal force by or against DoD forces).
    - (c) Risk (safety of DoD forces).
    - (d) Cost (including the source of funding and the effect on the DoD budget).
    - (e) Appropriateness (whether providing the requested support is in the interest of DoD).
    - (f) Readiness (impact on DoD's ability to perform its other primary missions).
  - (3) The CCDR (USNORTHCOM or USPACOM) may approve MAs within the CCDR's existing authorities (e.g., standing SecDef -approved EXORD).
  - (4) If the CCDR does not have the authority to approve the MA, the CCDR forwards the MA to Joint Staff /Homeland Defense Division, DSCA Branch (J33). Joint Staff/J33 forwards the request to OASD(

HD&GS) and the DoD Executive Secretariat for staffing (OSD-level) and SecDef decision. The ASD(HD&GS) has been delegated the authority to approve requests for certain forms of assistance in accordance with DoDD 5111.13. The Joint Staff/J33 prepares an EXORD for SecDef approval, if appropriate. If approved, DoD provides support. For life-saving and time-sensitive MAs, the approval may be made verbally with confirmatory documents to follow.

b. FEMA MAs From the FEMA Administrator (National Level).

There are occasions where the FEMA Administrator may request that federal partners provide capabilities without a FEMA region request.

(1) The FEMA Administrator may present a FEMA MA to the DoD liaison element at the National Response Coordination Center (NRCC).

(2) The DoD liaison element at the NRCC conducts the necessary coordination to ensure that the DCOs in the affected FEMA regions understand the purpose of the Administrator's MA. DoD may deploy the requested capability to a DoD installation and be prepared to employ when the affected FEMA region requests the capability.

(3) The DCO in the affected region processes employment of the FEMA MA.

(4) If the FEMA region JFO in which the requested capability will be employed is not activated, the DoD LNO element at the NRCC will forward the MA to the geographical CCDR (CDRUSNORTHCOM or CDR USPACOM). The CCDR may approve MAs within the CCDR's existing authorities (normally pursuant to a standing SecDef-approved EXORD).

(5) If a CCDR does not have the authority to approve the MA, the CCDR forwards the MA to Joint Staff/J33 for staffing and SecDef decision. SecDef has delegated the authority to approve requests for certain forms of assistance, in accordance with DoDD 5111.13.

### **20-18. Immediate Response Authority (IRA)**

Unique circumstances allow commanders to respond immediately, without requesting approval, to imminently serious conditions that are beyond the capability of local authorities. Local commanders can respond on their own authority to requests for assistance to save lives, to prevent human suffering, and to mitigate great property damage. Once initiated, the commander must inform the DOD Executive Agent through command channels as soon as possible but no less than three hours; this notification is not a request for approval. Associated costs should be recorded for potential reimbursement later. Immediate response is normally of short duration, DOD policy suggests no longer than 72 hours after which formal approval should be obtained if continued support is required.

### **20-19. Emergency Authority**

This authority is provided in DODD 3025.18. In extraordinary emergency circumstances where prior authorization by POTUS is not possible and duly constituted local authorities are unable to control a situation, federal military commanders have the authority to engage temporarily in activities that are necessary to quell large-scale, unexpected civil disturbances. Such activities need to be necessary to prevent significant loss of life or wanton destruction of property and should be necessary to restore governmental function or public order. The other circumstance appropriate leading to the implementation of emergency authority is when duly constituted federal, state or local authorities are unable to decline to adequately protect federal property or federal governmental functions.

### **20-20. Media Considerations**

a. During DSCA operations, the media provides invaluable services that can benefit both responding organizations and the public. When considering what information can and should be released to the media, leadership should consider the need to get accurate and timely information to the public; sensitivity of the information; the possibility of causing panic; building confidence and hope within the affected communities; correction of false information caused by rumors and distorted reporting. Leadership should strive to ensure the media get as complete and accurate a story as possible, while ensuring that their activities do not adversely affect public safety or compromise the response activities.

b. A Joint Information Center (JIC) is usually established to interface with the media. While DOD representatives are usually represented, it is generally in the nation's interest that, whenever possible,



there is a local or state spokesperson engaging the media as opposed to a federal, including active duty military, spokesperson.

c. For major incidents, DOD will publish public affairs guidelines applicable to all participating DOD organizations. The guidance will outline any constraints and the policies for media interaction and contain relevant command messages. Two common command messages are often addressed; civilian authorities are in charge, and military forces are supporting the nation in time of need.

## Section V

### Defense Support of Civil Authorities Mission Category—Disasters and Declared Emergencies

#### 20-21. Department of Defense National Response Force Response Process

a. When a disaster occurs and local and state resources are inadequate, POTUS invokes the Stafford Act with a Presidential disaster declaration, thereby releasing Disaster Relief Fund (DRF) monies. While DOD will often take risk with regard to reimbursement and execute some pre-declaration actions, DOD involvement formally begins after the declaration. The JDOMS execute order (EXORD) designating the supported CCDR will also designate supporting DOD agencies and direct the CCDR appoint a DCO.

b. The DCO activates the DCE and deploys to the JFO to coordinate DOD support for the disaster. Designated federal forces respond to taskings for support validated by the DCO. The DCO has OPCON of all DOD personnel (less ESF #3) deployed in support of the disaster unless a JTF is established. The DCO will receive requests for assistance from the FCO as already described.

c. Tiered Mission Command Options. Based on the type and magnitude of an emergency or disaster, USNORTHCOM will establish mission command relationships based on a flexible, tiered construct.

(1) Small Scale Events can be handled by a DCO, his DCE and EPLOs.

(2) Medium Scale Events require deployment of a mission command headquarters such as JTF-CS or one of USARNORTH's two Operational Command Posts. While there could be exceptions, a medium scale Joint Task Force (JTF) is likely to be commanded by a two star flag officer. The NRF directs that if a JTF is established, its mission command element will be collocated with the PFO at the JFO to ensure coordination and unity of effort.

(3) Large scale events, usually employing multiple JTFs, require an overarching JTF or functional component command. While there could be exceptions, these headquarters will most likely be commanded by a three star flag officer. Any level headquarters can be augmented with special expertise such as a Joint Planning Augmentation Cell (JPAC).

d. Dual Status Command Option. One mission command option to further the unity of effort between National Guard and federal forces is a dual status command (see Ch. 6 para 6-17. f.) whereby a JTF Commander serves in both a Title 10 status in command of federal forces while simultaneously serving in a Title 32 status in command of State National Guard forces. Only the commander holds dual status, not the commander's staff(s) and the forces in the command retain their federal and state chains of command. The dual status commander must therefore exercise his authority in a mutually exclusive manner, respecting the often different laws and policies, as well as Commanders in Chief, applicable for both types of forces under his command. A Memorandum of Agreement (MOA) must be signed by both the Governor and POTUS, although OSD is expected to request from POTUS standing delegation authority to the SECDEF to approve/appoint a dual status commander. Recent experience indicates that the dual-status C2 structure may work best for events where there is an extensive amount of time available for advance coordination and development of the MOA. Either party can terminate the agreement at any time. Designed to allow a National Guard officer to command federal forces, 32 U.S.C. 315 authorizes an active duty commander to assume dual-status command if a governor would commission him/her in the State National Guard. A recent example is Hurricane Sandy 2012 in which dual status commanders were appointed in Maryland, New Hampshire, New Jersey, Massachusetts, New York, and Rhode Island.

e. The supported CCDR will designate a Base Support Installation (BSI), at least one for each disaster. A BSI is a military installation designated to provide joint administrative and logistical support to DOD

forces. Selection is based on geographic proximity to an operation, functional capability, and coordination with service regional planning agents.

### **20-22 Department of Defense Incident Response**

a. The DSCA Standing Execute Orders (EXORD) empowers the CCDR to more rapidly respond in support of a primary federal agency. There are Standing EXORDs for natural or manmade disasters short of terrorist attack and a separate EXORD for a CBRN incident. The DSCA Standing EXORD specifies four distinct categories of CCDR authorizations from assigned forces (Category 1) to those forces required for large-scale response (Category 4).

b. Pre-Scripted Mission Assignments (PSMA) assist with ensuring support is delivered as rapidly as possible. PSMA are “fill-in-the-blank” templates for the most likely capabilities to be requested of DOD.

c. Request For Forces (RFF). As an exception to the usual RFA process, USNORTHCOM authorizes DCOs to more quickly respond to anticipated requirements by using the RFF process. They do, however, anticipate reimbursement by including a cost estimate.

d. Joint Publication 3-28 Defense Support of Civil Authorities provides commanders and staffs overarching doctrine for conducting DSCA operations. It specifies six phases which can be conducted simultaneously.

- (1) Phase I—Shape
- (2) Phase II—Anticipate
- (3) Phase III—Respond
- (4) Phase IV—Operate
- (5) Phase V—Stabilize
- (6) Phase VI--Transition

### **20-23. Unique Chemical, Biological, Radiological, Nuclear (CBRN) Response Considerations**

a. CBRN is defined as a chemical, biological, radiological, or nuclear or incident including industrial accidents, acts of nature, war or terrorism. A Weapon of Mass Destruction (WMD) is a Chemical, biological, radiological, or nuclear weapon capable of a high order of destruction or causing mass casualties, and excluding the means of transporting or propelling the weapon where such means is a separable and divisible part from the weapon.

b. CBRN Planning Considerations. Unique considerations for CBRN planning include that incidents may not be initially recognized as CBRN until there are multiple CBRN-specific casualties. For example, an explosive Radiological Dispersal Device (RDD) may be first identified as an IED until someone checks for radiation... radiation-specific casualties from even a highly radioactive RDD may take significant time to appear. Once identified as a CBRN event, an incident location will probably be treated as a crime scene. Responders will be at a higher risk of becoming casualties and the effects may contaminate critical facilities and infrastructure in the area. Planners must anticipate mass casualty decontamination and CBRN-specific mortuary affairs support. In addition to expecting state and local capabilities to be overwhelmed, planners must remain ready for multiple attacks. FEMA’s new Incident Annexes, such as the Nuclear/Radiological Incident Annex to the Response and Recovery Federal Interagency Operational Plans (NRIA), are of high value to CBRN DSCA Planners and exercise designers.

c. State National Guard CBRN Structure / CBRN Response Enterprise. In October 1998, to enhance the national capability to deal with CBRN CM, Congress authorized and funded the first ten National Guard Rapid Assessment and Initial Detection (RAID) Teams, renamed Civil Support Teams (CSTs). Larger, more capable organizations covering multiple states soon emerged, although these remain under State National Guard control.

(1) CSTs. The 57 CSTs nation-wide are comprised of 22 full-time Title-32 National Guard Soldiers, highly trained in a cross-discipline of functional areas. Their mission is to deploy; assess a situation; detect and identify CBRN materials, advise local, state, and federal response elements and facilitate sound public safety decisions. CSTs are unique, in that they are one of a few DOD units authorized by Congress to conduct CBRN response within CONUS. CSTs are a national resource and can move across state lines and provide support to another state, but are still maintained under state control. CSTs

can deploy within three hours (plus travel distance) and are commonly pre-deployed in support of key events.

(2) The CBRNE Enhanced Response Force Package (CERFP) is designed to rapidly deploy in less than six hours. The 17 National Guard CERFP teams provide a regional response capability to augment the CSTs. They can locate and extract victims from a CBRN incident site, perform mass casualty decontamination, medical triage and stabilization. They also include a Fatality Search Recovery Team (FSRT). CERFPs are task organized from existing units.

(3) HRF. As it became clear that the DoD's federal response was too slow to respond to a catastrophic CBRN incident, the idea of creating a regional response from National Guard assets was proposed. The ten HRFs (one in each FEMA region) are assigned 577 personnel and consist of Chemical, Biological, Radiological, and Nuclear (CBRN) assessment, search/extraction, decontamination, emergency medical, security, logistics support, and C2. HRFs deploy in 6-12 hours plus travel time.

d. DoD's Federal CBRN Structure / CBRN Response Enterprise.

(1) Defense CBRN Response Force (DCRF) is a joint, multi-component (primarily COMPO I) organization that provides DoD's federal CBRN response of 5,200 Soldiers to augment ten National Guard regional Homeland Response Forces (HRF). Capabilities include search and recovery, decontamination and logistic support. DCRF Force Package I, consisting of the first 2000 Soldiers, deploys in 24 hours, with the remaining forces arriving in 48 hours.

(2) Command and Control CBRN Response Element (C2CREs) are Reserve Component organization that provides a federal military CBRNE response of about 2000 troops to augment ten National Guard regional Homeland Response Forces (HRF) in place of the RCCMRF. There are currently two C2CREs; C2CRE-A is primarily COMPO III and C2CRE-B is primarily COMPO II. C2CREs arrive within 96 hours of a CBRN event.

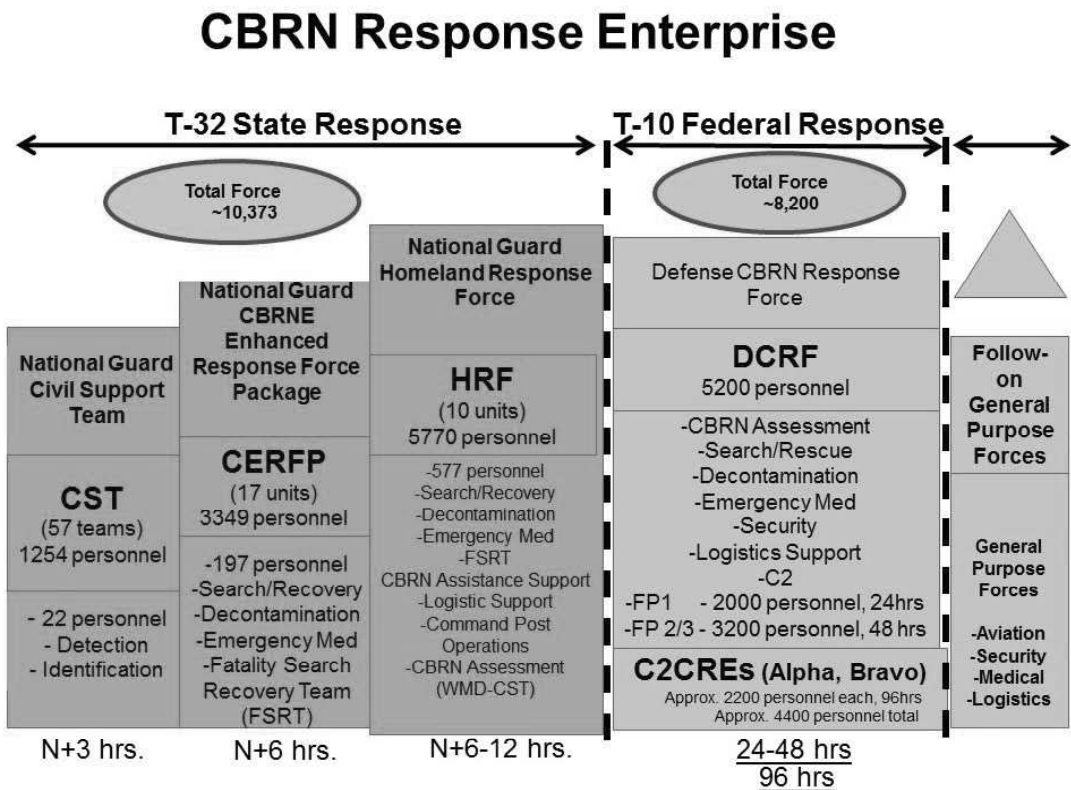

Figure 20-3. CBRN Response Enterprise

## HOW THE ARMY RUNS

e. Non-DOD Federal CBRN Response: It is beyond the scope of this chapter to detail an exhaustive list of federal CBRN response assets but the reader should know that significant federal capabilities exist and have an appreciation for the roles and missions of organizations DOD might encounter or support.

(1) Department of Energy (DOE) Nuclear Emergency Support Teams (NEST) provide specialized response to the technical aspects of an unresolved incident involving nuclear or radiological devices. Capabilities include search and identification of nuclear materials, diagnostics and assessment of suspected nuclear devices, technical operations in support of render safe procedures and packaging for transport to final disposal.

(2) Environmental Protection Agency Environmental Response Teams (EPAERT) and Radiological Emergency Response Team (RERT) deal with the human health and environmental impact of terrorist attacks. The EPA's research laboratories offer field monitoring and technical support to quality-assurance programs for air, water, wastewater and solid waste. Some of these laboratories are capable of deploying mobile units to a contaminated site.

(3) The FBI Hazardous-Materials Response Unit (HMRU) has specialized sampling, detection and identification capabilities of NBC agents. Evidence Response Teams (ERTs) provide crime-scene documentation and evidence collection in support of criminal investigations.

(4) USCG National Strike Force is trained and equipped to assist in responding to major oil or hazardous material spills, particularly in a maritime environment.

(5) Department of Health and Human Services (HHS) coordinates the National Medical Response Teams for WMD that deal with the medical consequences of incidents involving CBRN. In addition, HHS' Centers for Disease Control and Prevention has special responsibilities in the event of terrorism involving infectious agents.

f. DOD has other organizations that assist with the response to a CBRN event.

(1) Defense Threat Reduction Agency (DTRA) exists to safeguard the U.S. and its allies from WMD (CBRN) by providing capabilities to predict, model, reduce, eliminate and counter the threat and mitigate CBRN effects.

(2) USMC Chemical-Biological Incident Response Force (CBIRF) responds to CBRN incidents to assist local, state or federal agencies and designated CCDRs with CM operations. CBIRF capabilities include agent detection and identification, casualty search and rescue, personnel decontamination and emergency medical care to stabilize contaminated victims.

(3) U.S. Army 20<sup>th</sup> Chemical Biological Radiological Nuclear Explosives Command (CBRNE) integrates, coordinates, deploys and provides trained and ready forces. It is also prepared to mission command CBRNE operations. The 20<sup>th</sup> CBRNE Cmd provides training and readiness oversight of Army CBRNE assets (active and reserve) to include the 22<sup>nd</sup> Chemical Battalion, 52<sup>nd</sup> Ordnance Group and the US Army Reserve Consequence Management Unit (CMU).

(4) All the services have Explosive Ordnance Disposal (EOD) units; the Army has chemical brigades, battalions and companies with most of the Army capability residing in the US Army Reserve. The Edgewood Chemical Biological Center is the principal research and development center for chemical and biological defense technology.

(5) U.S. Army Medical Command (MEDCOM) also provides a variety of CBRN support. The U.S. Army Medical Research Institute of Chemical Defense (USAMRICD) and U.S. Army Medical Research Institute of Infectious Diseases (USAMRIID) not only conduct research, but provide teams to advise and assist with the medical aspects of incidents. MEDCOM also provides operational Special Medical Augmentation Response Teams (SMART) to provide emergency medical response and a variety of other related services in support of a terrorist attack. These teams can also respond to a non-CBRN natural disaster.

**Section VI****Defense Support of Civil Authorities Mission Category—Restore Public Health and Services and Civil Order****20-24. Support to Law Enforcement**

a. When armed and so used, military forces, will adhere to the Standing Rules for the Use of Force (SRUF) unless the SECDEF has approved mission-specific RUF.

(1) The Posse Comitatus Act of 1878 (PCA), subsequent amendments and policy decisions prohibits the use of federal military forces (to include Reserve forces) to perform internal police functions. PCA thus restricts the type of support DOD can provide domestic law enforcement organizations.

(2) There are a wide variety of exceptions to the PCA but, the law essentially gives POTUS all the authority needed to employ DOD forces inside the U.S., although there may appropriately be political consequence that would inhibit such employment. The PCA law itself makes provision for POTUS's Article II Constitutional authority. The Act does not pertain to the National Guard when in state status, nor does it apply to the U.S. Coast Guard. There are also a variety of statutory exceptions such as the Protection of Nuclear Materials Act (18 U.S.C. 831), Chemical-Biological Terrorism (10 U.S.C. 382) and Secret Service Assistance (10 U.S.C. 3056). The most renowned statutory exception is The Insurrection Act (10 U.S.C. 331-334), which applies primarily to responses to civil disturbances.

b. POTUS is authorized by the Constitution and Title 10 (10 U.S.C. 331-334) to suppress insurrections, rebellions, and domestic violence by issuing a Cease and Desist Order (CDO). After issuing a CDO, POTUS issues an executive order that directs the Attorney General and the SECDEF to take appropriate steps to disperse insurgents and restore law and order. The Attorney General is then responsible to coordinate the federal response to domestic civil disturbances. The restrictions of the PCA no longer apply to federal troops executing the orders of POTUS to quell the disturbance in accordance with Rules of the Use of Force (RUF) approved by the DOD General Counsel and the Attorney General.

**20-25. Other Types of Public Health and Services DSCA**

a. In the event of a work stoppage or disaster leading to disruption of mail service, DOD may be required to provide support to the U.S. Postal Service (USPS) to safeguard process and deliver the mail to areas in which service has been impaired.

b. DOD would provide the U.S. Department of Agriculture (USDA) assistance for emergencies requiring the containment and eradication of plant or animal diseases.

c. DOD medical support would generally be provided to Department of Health and Human Services (DHHS) using the mechanisms of NRP ESF#8 (Health and Medical Services). An important aspect of the ESF#8 process is the National Disaster Medical System (NDMS), a public, private sector partnership involving DHS, DHHS, DOD, and Department of Veteran Affairs. Assisting in the enforcement of quarantines is specifically allowed by DoD under Posse Comitatus.

d. The Environmental Protection Agency (EPA) and DHS-U.S. Coast Guard have responsibilities for oil and hazardous substance spills.

e. The National Interagency Fire Center (NIFC), a joint Department of Agriculture and Department of Interior organization is responsible for coordinating the federal response to wild fires. DOD provides resources for the containment, control and extinguishing of wild fires on lands owned by the federal government.

f. Mass immigration emergencies could result in DOD providing other federal agencies with support such as installations and services associated with housing migrants while the Immigration and Naturalization Service resolves the administrative requirements for migrants to enter the U.S.

## Section VII

### Defense Support of Civil Authorities Mission Category—Special Events and Planned Periodic Support

#### 20-26. Defense Support of Civil Authorities Mission Category—Special Events

a. Pursuant to HSPD-7, the Secretary of HS, after consultation with the HS Council (HSC), is responsible for designating events a National Special Security Event (NSSE). These special events of national significance can be political, economic or international sporting events. When an event is designated an NSSE, the Secret Service assumes its mandated role as lead for security planning and DOD supports the USSS. Examples of military assets that may be deployed include EOD, technical escort unit teams and CBRN assets. If an incident occurs at an NSSE, the FBI leads the law enforcement and criminal investigation efforts, and FEMA leads response and recovery efforts. Most events are not designated NSSEs, but may still receive DOD support.

b. JDOMS plans, coordinates, and monitors execution of approved DOD support to other special events as categorized by the DHS Special Events Working Group. Events of a lesser significance are designated Special Events for HS (SEHS) levels 1 to 4, SEHS Level 4 being the lowest priority. DOD focuses on support related to public safety and security, including but not limited to, physical security, aviation, logistics, communications, joint operations and command centers, and explosive ordnance disposal support. DOD support for events may be reimbursable or non-reimbursable depending on the type of support provided and the nature of the event.

c. DOD is authorized under Title 10, U.S.C. 2554 to provide support to international sporting competitions (SISC) if the Attorney General certifies that support is essential to the safety and security of the event. Congress has established a revolving fund to cover SISC operational expenditures.

d. DOD supports other special events as demonstrated by the many State Designated Special Events that National Guard forces support while on state status under a governor's control.

#### 20-27. Defense Support of Civil Authorities Mission Category—Periodic Planned Support

a. This category enhancing civil-military relations includes DOD laboratory support; specialized and mobile training programs; participation in local, state and federal emergency management exercises; support provided to the Secret Service under 18 U.S.C. 112; and provision of military bands or honorary fly-over at civic events. It includes Military community affairs programs and community relations programs administered by the Assistant Secretary of Defense for Public Affairs.

b. Installation commanders are authorized under the Installation Mutual Aid Agreements, U.S.C. Title 42, Section 1856a-c to enter into limited mutual aid agreements with local communities, usually for fire, emergency medical or hazardous material response. It should be noted that while such memorandums may improve understanding about what resources DOD may be able to provide, they do not constitute preapproved support. Requests must be approved or be provided under some established authority such as Immediate Response authority.

c. Military Assistance to Safety and Traffic (MAST), governed by DODD 4500.9, authorizes medical helicopter units to provide emergency assistance if local resources are not available or are not sufficient to respond to emergencies. Under this directive, there is no reimbursement, units may not relocate to provide service, and they must operate within their allocated training hour program.

## Section VIII

### Summary and References

#### 20-28. Summary

a. The U.S. has a time-tested tradition of civilian control over the military and of limiting military activity within its borders. Balancing that valued tradition with the need for military support in response to disaster and acts or threats of terrorism within the U.S. requires approval by the most senior civilian officials within our government.

b. The military has available a unique blend of skilled personnel and equipment capable of rapid and effective responses in support of appropriate civil authority. By policy, requests for military resources are only approved when the capacity or resources of other federal, state, and local agencies is exceeded and the crisis remains unresolved.

c. The military continues to provide reliable and responsive DSCA. Moreover, the Army's extensive experience in supporting civil authorities during peacetime disasters, national security emergencies, and special events enhances HS and has kept the U.S. Army in the forefront of domestic disaster response. The military's force projection capability, designed to respond quickly and decisively to global requirements, also allows its rapid response to domestic incidents that occur within the U.S., its territories and possessions. The judicious use of military forces in support of civil requirements complements the military's war fighting and force projection capabilities, while insuring the American people get maximum return from their military investment.

## 20-29. References

### a. Publications -

- (1) 10 USC Sect. 331-335, Enforcement of the Laws to Restore Public Order.
  - (2) 10 USC Sect 372-380, Military Support for Civilian Law Enforcement Agencies.
  - (3) 18 USC Sect 1385, Use of Army and Air Force as Posse Comitatus (with revisions).
  - (4) 31 USC Sect 1535, Economy Act.
  - (5) ADRP 3-28 Defense Support to Civil Authorities, June, 2013.
  - (6) ATP 3-28.1 Multi-service Tactics, Techniques and Procedures for Defense Support of Civil Authorities (DSCA), September, 2015.
  - (7) CJCSI 3125.01D, Defense Support to CBRN Incidents in the Homeland, 7 May 2015.
  - (8) CJCSI 3710.01B, DOD Counterdrug Support, 26 Jan 2007.
  - (9) HSPD-7, Critical Infrastructure Identification, Prioritization and Protection, 2015.
  - (10) DODD 3020.40, Defense Critical Infrastructure Program (DCIP), 2012
  - (11) DODD 2025.18, DSCA, w/Chg 1, September 2012.
  - (12) DODD 3025.21 Defense Support of Civil Law Enforcement Agencies, 27 February 2013.
  - (13) DOD Manual 3025.01, Volumes 1-3, Defense Support to Civil Authorities, 11 August 2016.
  - (14) FEMA Publication 1, April, 2016.
  - (15) JP 3-07.2, Antiterrorism, 2010.
  - (16) JP 3-26, Counterterrorism, 24 October, 2014.
  - (17) JP 3-27, Homeland Defense, 29 July 2013.
  - (18) JP 3-28, Defense Support to Civil Authorities, 31 July 2013.
  - (19) JP 3-41, CBRN Response, 9 September 2016.
  - (20) Mitigation Federal Interagency Operational Plan, Second Edition, August 2016
  - (21) National Incident Management System (NIMS), October, 2017.
  - (22) Presidential Policy Directive 8 (PPD-8), National Preparedness, Mar 2011.
  - (23) Protection Federal Interagency Operational Plan, August 2016
  - (24) Public Law 100-707, The Stafford Act (as amended August 2016) / 42 USC Sect. 5121).
  - (25) Public Law 104-201, Defense Against Weapons of Mass Destruction Act of 1996 (Nunn-Lugar-Domenici).
  - (26) Public Law 106-65, NDAA for FY 2000, Section 1023, Assistance to Civil Authorities to Respond to Act or Threat of Terrorism..
  - (27) Public Law 107-56, The Patriot Act.
  - (28) Public Law 107-296, The Homeland Security Act of 2002.
  - (29) Recovery Federal Interagency Operational Plan, Second Edition, August 2016
  - (30) Response Federal Interagency Operational Plan, Second Edition, August 2016
- ### b. Usefull Links
- (1) <https://www.fema.gov/mission-areas>
  - (2) <https://www.fema.gov/federal-interagency-operational-plans>
  - (3) <https://www.dhs.gov/presidential-policy-directive-8-national-preparedness>
  - (4) <https://www.dhs.gov/sites/default/files/publications/20101013-dod-dhs-cyber-moa.pdf>

## Terms

**Allocation.** Distribution of limited forces and resources for employment among competing requirements.

**Anticipation.** The ability to foresee events and requirements and initiate necessary actions that most appropriately satisfy a response without waiting for operations orders or fragmentary orders.

**Apportionment.** In the general sense, distribution of forces and capabilities as the starting point for planning.

**Asset Leverage.** The combination of government assets with private sector knowledge, expertise, equity and or financing in a venture (partnership) which results in long term benefit to the government.

**Budget Activity 1.** Operating Forces.

**Budget Activity 2.** Mobilization.

**Budget Activity 3.** Training and Recruiting.

**Budget Activity 4.** Administration and Service-Wide Activities.

**Budget Authority.** The authority to incur a legal obligation to pay a sum of money from the U.S. Treasury. BA is not "money." The U.S. Treasury actually disburses cash only after an agency (e.g., DFAS) issues a U.S. Treasury check withdrawing money from the Treasury and thus disburses the money to pay a previously incurred obligation.

**Capability Developer.** A person who is involved in analyzing, determining, prioritizing, and documenting requirements for doctrine, organization, training, materiel, leadership and education, personnel, facilities, and policy (DOTMLPF-P) implications within the context of the force development process. Also responsible for representing the end user during the full development and lifecycle process and ensures all enabling capabilities are known, affordable, budgeted, and aligned for synchronous fielding and support. The CAPDEV is the command or agency that formulates warfighting requirements for DOTLMPF-P. The acronym CAPDEV may be used generically to represent the user and user maintainer community role in the materiel acquisition process (counterpart to generic use of MATDEV).

**Capability Development.** The analysis, determination, prioritization, and documentation of requirements for doctrine, organization, training, materiel, leadership and education, personnel, facilities, and policy implications within the context of the force development process.

**Capital Planning and Investment Control.** The management process for ongoing identification, selection, control, and evaluation of investments in information resources. The process links budget formulation and execution, and is focused on agency missions and achieving specific program outcomes.

**Combatant Command.** A unified or specified command with a broad continuing mission under a single commander established and so designated by the President, through the Secretary of Defense and with the advice and assistance of the Chairman of the Joint Chiefs of Staff.

**Combatant Commander.** A commander of one of the unified or specified combatant commands established by the President. Also called CCDR.

**Communications.** JP 6.0 describes a joint communications system as one that is comprised of the networks and services that enable joint and multinational capabilities. The objective of the joint communications system is to assist the JFC in C2 of military operations. Effective C2 is vital for proper integration and employment of capabilities. The HQDA's end-to-end communications system supporting the JFC is called the LandWarNet. The DODIN conceptually unifies DOD's information systems and networks into a real-time information system of systems that provides increased information capabilities to



the joint force. Communications systems are more than electronic boxes, wires, and radio signals, and the DODIN is more than a collection of information networks. The interdependence of the parts, as well as the processes, policy, and data on those systems, permeate daily life, and preparation for and execution of operations. An effective communications system helps commanders maintain the unity of effort to apply their forces' capabilities at critical times and places to achieve objectives.

**Community Engagement.** Those public affairs activities that support the relationship between military and civilian communities, domestically and in military operations.

**Congressional Appropriation.** A law passed by the Congress and signed by POTUS that provides BA for the specific purpose(s) stated in the law. In the case of the annual DOD appropriations act (e.g., Public Law 111-118, Department of Defense Appropriations Act, 2015) BA is provided for a number of appropriations (e.g., OMA; Military Personnel, Army (MPA); RDT&E,A; MCA) for a specified period of time for the Army to incur legal obligations as it executes the programs authorized by Congress and other laws that guide Army operations.

**Congressional Authorization.** A law passed by the Congress and signed by POTUS that establishes or continues a federal program or agency, and sets forth guidelines to which it must adhere. Generally for every FY, the Congress passes an NDAA (e.g., Public Law 111-383, Ike Skelton National Defense Authorization Act for Fiscal Year 2015), which directs by law what can be purchased, what manpower resource levels each service can have, and how many weapon and other materiel systems can be bought. It also provides additions and changes to Title 10 USC that, among other laws, guide the management of the Army and the other activities of the DOD. An authorization act does not provide the BA to draw funds from the U.S. Treasury to pay an obligation.

**Container Management.** The process of establishing and maintaining visibility and accountability of all cargo containers moving within the Defense Transportation System.

**Continuity.** The uninterrupted provision of sustainment across all levels of war.

**Cost-Benefit Analysis.** A structured methodology for forecasting and comparing the anticipated costs and benefits of alternative courses of action in order to identify the optimum solution for achieving a stated goal or objective. The goal is to produce a strong value proposition—a clear statement that the benefits more than justify the costs, risks, and bill payers.

**Cyberspace Operations.** CO includes offensive cyberspace operations, defensive cyberspace operations, and DODIN operations.

**Department of the Army.** The executive part of the Department of the Army at the seat of government and all field headquarters, forces, Reserve Component, installations, activities, and functions under the control or supervision of the Secretary of the Army. Also called DA.

**Deployment Order.** A planning directive from the Secretary of Defense, issued by the Chairman of the Joint Chiefs of Staff, that authorizes and directs the transfer of forces between combatant commands by reassignment or attachment. Also called DEPORD.

**Directive Authority for Logistics.** The combatant commander's authority to issue directives to subordinate joint force commanders of service component commands for as many common support capabilities required to accomplish the assigned mission.

**Disbursement.** Payment of an obligation of the U.S. Government.

**Document Integrator.** Ensures that requirements and authorization documents meet approved Army force programs and link requirements, planned or programmed force structure actions, and the documentation processes.

## HOW THE ARMY RUNS

**Economy.** Providing sustainment resources in an efficient manner that enables the commander to employ all assets to the greatest effect possible.

**End Strength.** The total number of personnel authorized by the Congress to be in the Army on the last day of the Fiscal Year (FY) (30 September). This is normally provided in the National Defense Authorization Act (NDAA).

**Fiscal Year.** The FY is the government's accounting period. For the federal government, it begins on 1 October and ends on 30 September. The FY is designated by the calendar year in which it ends. For example, FY 2015 begins on 1 October 2014 and ends on 30 September 2015.

**Force Development.** The process of determining Army doctrinal, leader development, training, organizational, Soldier development, and materiel requirements and translating them into programs and structure, within allocated resources, to accomplish Army missions and functions.

**Force Integration.** The synchronized, resource-constrained execution of an approved force development program to achieve systematic management of change, including: the introduction, incorporation, and sustainment of doctrine, organizations, and equipment in the Army; coordination and integration of operational and managerial systems collectively designed to improve the effectiveness and capability of the Army; and knowledge and consideration of the potential implications of decisions and actions taken within the execution process.

**Force Integrator.** A manager of resourcing, documentation, fielding, and sustainment to assure doctrinal, operational, and technical integration of functionally dissimilar organizations. Responsible for the horizontal integration of large units such as brigades, regiments, groups, divisions and corps.

**Force Management.** The capstone process to establish and field mission-ready Army organizations. The process involves organization, integration, decision-making, and execution of the spectrum of activities encompassing requirements definition, force development, force integration, force structuring, combat developments, materiel developments, training developments, resourcing, and all elements of the Army Organizational Life Cycle Model (AOLCM).

**Force Modernization.** The process of improving the Army's force effectiveness and operational capabilities through force development and integration.

**Force Structure.** The manpower and materiel composition, by number and type of organizations, of the current, planned, or programmed Total Army tasked to perform missions in peace and war.

**Force Structure Allowance.** The sum of authorized spaces contained in all Modification Tables of Organization and Equipment units and Table of Distribution and Allowances type organizations.

**Future Years Defense Program.** Program and financial plan for the DOD as approved by the Secretary of Defense. The FYDP arrays cost data, manpower, and force structure over a 5-year period (force structure for an additional 3 years), portraying this data by major force program for DOD internal review for the program and budget review submission. It is also provided to the Congress annually in conjunction with the President's budget.

**Improvisation.** The ability to adapt sustainment operations to unexpected situations or circumstances affecting a mission.

**Individuals Account.** This account, often referred to as the Trainee, Transient, Holdee, and Student (TTHS) account, is comprised of those personnel unavailable to fill spaces in units. The six sub-accounts are trainees, officer accession students, transients, holdees (short explanation needed), students, and U.S. Military Academy (USMA) cadets.

**Information Management.** The planning, budgeting, manipulating, and controlling of information throughout its life cycle.

**Information Resource Management.** The process of managing information resources to accomplish agency missions. The term encompasses both information itself and the related resources, such as personnel, equipment, funds, and information technology.

**Information Technology.** Any equipment or interconnected system or subsystem that is used in the automatic acquisition, storage, manipulation, management, movement, control, display, switching, interchange, transmission, or reception of data or information by an executive agency (EA). For purposes of the preceding sentence, equipment is used by an EA if the equipment is used by the EA directly or is used by a contractor under a contract with the EA which: one, requires the use of such equipment; or two, requires the use, to a significant extent, of such equipment in the performance of a service or the furnishing of a product. The term "information technology" includes computers, ancillary equipment, software, firmware, and similar procedures, services (including support services), and related resources. The term "information technology" does not include any equipment that is acquired by a federal contractor incidental to a federal contract. The term "information technology" does not include national security systems as defined in the CCA of 1996 (40 U.S.C. 1452).

**Instruments of National Power.** All of the means available to the government in its pursuit of national objectives. They are expressed as diplomatic, economic, informational, and military.

**Integration.** Combining all of the sustainment elements within operations assuring unity of command and effort.

**Intermodal Operations.** The process of using multiple modes (e.g., air, sea, highway, rail) and conveyances (e.g., truck, barge, containers, pallets) to move troops, supplies and equipment through expeditionary entry points and the network of specialized transportation nodes to sustain land forces.

**Internal Information.** Communication by a military organization directed to the internal audience that creates an awareness of the organization's goals, informs them of significant developments affecting them and the organization, increases their effectiveness as ambassadors of the organization, and keeps them informed about what is going on in the organization. Formerly, called Command Information.

**Joint.** Connotes activities, operations, organizations, etc., in which elements of two or more Military Departments participate.

**Joint Operation Planning.** Planning activities associated with joint military operations by combatant commanders and their subordinate joint force commanders in response to contingencies and crises.

**Joint Operation Planning and Execution System.** An Adaptive Planning and Execution system technology. Also called JOPES.

**Joint Operation Planning Process.** An orderly, analytical process that consists of a logical set of steps to analyze a mission, select the best course of action, and produce a joint operation plan or order. Also called JOPP.

**Joint Operations.** A general term to describe military actions conducted by joint forces and those service forces employed in specified command relationships with each other, which of themselves, do not establish joint forces.

**Joint Staff.** 1. The staff of a commander of a unified or specified command, subordinate unified command, joint task force, or subordinate functional component (when a functional component command will employ forces from more than one Military Department), that includes members from the several Services comprising the force. 2. (capitalized as Joint Staff) The staff under the Chairman of the Joint

## HOW THE ARMY RUNS

Chiefs of Staff that assists the Chairman and the other members of the Joint Chiefs of Staff in carrying out their responsibilities. Also called JS.

**Joint Strategic Capabilities Plan.** A plan that provides guidance to the combatant commanders and the Joint Chiefs of Staff to accomplish tasks and missions based on current military capabilities. Also called JSCP.

**Joint Strategic Planning System.** One of the primary means by which the Chairman of the Joint Chiefs of Staff, in consultation with the other members of the Joint Chiefs of Staff and the combatant commanders, carries out the statutory responsibilities to assist the President and Secretary of Defense in providing strategic direction to the Armed Forces. Also called JSPS.

**Joint Task Force.** A joint force that is constituted and so designated by the Secretary of Defense, a combatant commander, a subunified commander, or an existing joint task force commander. Also called JTF.

**LandWarNet.** LandWarNet is the portion of the DODIN operated by the Army. LandWarNet is the set of information solutions, and associated processes that collect, process, store, disseminate, and manage information on demand to warfighters, policy makers, and support personnel, whether interconnected or stand-alone, including owned and leased communications and computing systems and services, software (including applications), data, security services, other associated services, and national security systems.

**Logistics.** Planning and executing the movement and support of forces. It includes those aspects of military operations that deal with: design and development, acquisition, storage, movement, distribution, maintenance, evacuation, and disposition of materiel; acquisition or construction, maintenance, operation, and disposition of facilities; and acquisition or furnishing of services.

**Military Department.** One of the departments within the Department of Defense created by the National Security Act of 1947, which are the Department of the Army, the Department of the Navy, and the Department of the Air Force. Also called MILDEP.

**Materiel Developer.** The Research, Development, and Acquisition command, agency, or office assigned responsibility for the system under development or being acquired. The term may be used generically to refer to the Research, Development, and Acquisition community in the materiel acquisition process (counterpart to the generic use of CAPDEV).

**Materiel Development.** The research and development, production, and fielding of a new materiel system.

**Mode Operations.** The execution of movements using various conveyances (truck, lighterage, railcar, aircraft) to transport cargo.

**Movement Control.** The dual process of committing allocated transportation assets and regulating movements according to command priorities to synchronize distribution flow over lines of communications to sustain land forces.

**National Military Strategy.** A document approved by the Chairman of the Joint Chiefs of Staff for distributing and applying military power to attain national security strategy and national defense strategy objectives. Also called NMS.

**National Security Council.** A governmental body specifically designed to assist the President in integrating all spheres of national security policy. Also called NSC.

**National Security Strategy.** A document approved by the President of the United States for developing, applying, and coordinating the instruments of national power to achieve objectives that contribute to national security. Also called NSS.

**Obligation.** Any act that legally binds the USG to make a payment. The concept of the “obligation” is central to RM in the government. From the central concept of “obligating the USG to make a payment” springs forth the foundation of our fiscal law and the legal parameters under which the Army must operate as a part of the USG. The obligation may be for a service rendered by a contractor, the acquisition of materiel items (e.g., a tank), the construction or repair of a facility, or salary for a Soldier or civilian.

**Operating Strength.** Those Soldiers available to fill spaces in MTOE units and TDA organizations, sometimes referred to as the distributable inventory.

**Organization Integrator.** Branch assigned subject matter experts who: manage table of organization and equipment/modified table of organization and equipment units, by branch, to provide an operational view of change management; are the focal point for force accounting, documentation, resourcing, and readiness of assigned units; exercise resource controls for documentation; coordinate and recommend approval or disapproval of all branch specific actions and documentation; advise DCS, G-3/5/7 and G-3/7 Force Management on the disposition of branch actions at HQDA; and field access to the larger HQDA force management processes.

**Outlays.** Outlays are the amount of money the Government actually disburses in a given FY.

**Overall Category Level 1.** The unit possesses the required resources and is trained to accomplish or provide the core functions and fundamental capabilities for which it was designed or to undertake the mission it is currently assigned. The status of resources and training in the unit does not limit flexibility in methods to accomplish core functions or assigned missions nor increase vulnerability of unit personnel and equipment. The unit does not require any compensation for deficiencies.

**Overall Category Level 2.** The unit possesses the required resources and is trained to accomplish or provide most of the core functions and fundamental capabilities for which it was designed or to undertake most of the mission it is currently assigned. The status of resources and training in the unit may cause isolated decreases in the flexibility of choices to accomplish core functions or currently assigned missions. However, this status will not increase the vulnerability of the unit under most envisioned operational scenarios. The unit will require little, if any, compensation for deficiencies.

**Overall Category Level 3.** The unit possesses the required resources and is trained to accomplish or provide many, but not all, of the core functions and fundamental capabilities for which it was designed or to undertake many, but not all, portions of the mission it is currently assigned. The status of resource and training in the unit will result in significant decreases in flexibility to accomplish the core functions or the assigned missions and will increase vulnerability of the unit under many, but not all, envisioned operational scenarios. The unit will require significant compensation for deficiencies.

**Overall Category Level 4.** The unit requires additional resources or training to accomplish or provide the core functions and fundamental capabilities for which it was designed or to undertake the mission currently assigned; however, the unit may be directed to undertake portions of the assigned mission with resources on hand (available).

**Overall Category Level 5.** The unit is undergoing a HQDA-directed resource action and/or is part of a HQDA-directed program and is not prepared to accomplish or provide the core functions or fundamental capabilities for which it was designed. Units report C-5 in accordance with the policy and procedures established in paragraph 4–8 of AR 220-1. Level 5 is not applicable to A-Level reporting. C-5 units are restricted to the following: units undergoing activation, inactivation, conversion, or other HQDA directed resource action; units that have their levels for authorized personnel and/or equipment established so that, even when filled to the authorized level, the established level does not allow the unit to achieve level 3 or higher; and units that are not manned or equipped but are required in the wartime structure.

**Personnel Services.** Sustainment functions that man and fund the force, maintain Soldier and Family readiness, promote the moral and ethical values of the nation, and enable the fighting qualities of the Army.

## HOW THE ARMY RUNS

**Port Opening.** The ability to establish, initially operate and facilitate throughput for ports of debarkation to support unified land operations.

**Program Objective Memorandum.** The final product of the programming process within the DOD, the DOD Component's POM displays the resource allocation decisions of the Military Departments in response to and in accordance with planning and programming guidance (DODD 7045.14).

**Public Affairs.** Those internal information, public information, and community engagement activities directed toward both the external and internal publics with interest in the DOD.

**Public Affairs Guidance.** Constraints and restraints established by proper authority regarding public information, command information, and community relations activities. It may also address the method(s), timing, location, and other details governing the release of information to the public.

**Public Information.** Within public affairs, that information of a military nature, the dissemination of which is consistent with security and approved for release.

**Readiness Assessment Level 1.** Issues and/or shortfalls have negligible impact on readiness and ability to accomplish assigned mission(s) in support of the NMS as directed in the Global Employment of the Force and Joint Strategic Capabilities Plan.

**Readiness Assessment Level 2.** Issues and/or shortfalls have limited impact on readiness and ability to accomplish assigned mission(s) in support of the NMS as directed in the GEF and JSCP.

**Readiness Assessment Level 3.** Issues and/or shortfalls have significant impact on readiness and ability to accomplish mission(s) in support of the NMS as directed in the GEF and JSCP.

**Readiness Assessment Level 4.** Issues and/or shortfalls preclude accomplishment of assigned mission(s) in support of the NMS as directed in the GEF and JSCP.

**Resource Management.** RM is the direction, guidance, and control of financial and other resources. It involves the application of programming, budgeting, accounting, reporting, analysis, and evaluation.

**Responsiveness.** The ability to react to changing requirements and respond to meet the needs to maintain support.

**Staff Synchronization Officer.** The Army G-8 SSO is charged with the synchronization of the JCIDS, force structure, DAS, PPBE and equipment allocation processes in support of recommending an affordable equipment modernization investment strategy that best balances approved equipment modernization requirements and available fiscal resources to develop, procure, field and sustain material capabilities needed to meet ACP directed equipping objectives. In doing so, the SSO is a member of the force development team consisting of: The G-3/5/7 Requirements Staff Officer (RSO); the G-3/5/7 Organizational Integrator (OI); the NGB and OCAR System Integrator (SI); the Department of the Army System Coordinator (DASC); and, the ASC (LMI) Material Integrator (MI). As a member of this force development team, the SSO is not an acquisition system/program advocate, but rather, facilitates informed HQDA decision making that balances approved equipment modernization requirements and available fiscal resources in order to equip the force to meet Army Title 10 mission requirements.

**Strategic Direction.** The processes and products by which the President, Secretary of Defense, and Chairman of the Joint Chiefs of Staff provide strategic guidance to the Joint Staff, combatant commands, Services, and combat support agencies.

**Strategy.** A prudent idea or set of ideas for employing the instruments of national power in a synchronized and integrated fashion to achieve theater, national, and/or multinational objectives.

**Simplicity.** Relates to processes and procedures to minimize the complexity of sustainment.

**Sustainment.** The provision of logistics, personnel services, and health service support necessary to maintain operations until successful mission completion.

**Sustainment Preparation of the Operational Environment.** The analysis to determine infrastructure, physical environment, and resources in the operational environment that will optimize or adversely impact friendly forces means for supporting and sustaining the commander's operations plan.

**Sustainment Warfighting Function.** The related tasks and systems that provide support and services to ensure freedom of action, extended operational reach, and prolong endurance.

**System Integrator.** The coordinator for determining requirements, assuring operational and organizational documentation, coordinating, planning, and programming fielding, and recommending resourcing priorities for designated functional areas or specific materiel systems.

**Theater Closing.** The process of redeploying Army forces and equipment from a theater, the drawdown and removal or disposition of Army non-unit equipment and materiel, and the transition of materiel and facilities back to host nation or civil authorities.

**Theater Distribution.** The flow of equipment, personnel, and materiel within theater to meet the combatant commander's mission.

**Theater Opening.** The ability to establish and operate ports of debarkation (e.g., air, sea, and rail), establish a distribution system and sustainment bases, and to facilitate port throughput for the reception, staging, onward movement and integration of forces within a theater of operations.

**Total Strength.** The total of all personnel serving on active duty in the Army, including Soldiers in units and organizations and those in the individuals account.

**Training Developer.** The Army agency that determines requirements for a system's training subsystem and formulates, develops, and documents associated training concepts, strategies, plans, and required training support. IAW AR 71-9 is a subset of and included within capability developer; serves as the user's representative during development and acquisition of a system's training subsystem.

**Training Development.** The process of developing, integrating, prioritizing, resourcing and providing quality control/quality assurance of the Army's training and education concepts, strategies and products to support the Army's training and education of Active Army and Reserve component Soldiers, Civilians and units across the institutional, self-development and operational training domains.

**Unified Command.** A command with a broad continuing mission under a single commander and composed of significant assigned components of two or more Military Departments that is established and so designated by the President, through the Secretary of Defense with the advice and assistance of the Chairman of the Joint Chiefs of Staff. Also called unified combatant command.

**Unified Command Plan.** The document, approved by the President, that sets forth basic guidance to all unified combatant commanders; establishes their missions, responsibilities, and force structure; delineates the general geographical area of responsibility for geographic combatant commanders; and specifies functional responsibilities for functional combatant commanders.

## Glossary

<b>A2R</b>	Acquire to Retire
<b>A2SF</b>	Active Army Strength Forecaster
<b>AA</b>	Active Army
<b>AAC</b>	Army Acquisition Corps
<b>AACMO</b>	Army Acquisition Corps Management Office
<b>AAE</b>	Army Acquisition Executive
<b>AAFES</b>	Army and Air Force Exchange Service
<b>AAMMP</b>	Active Army Military Manpower Program
<b>AAO</b>	Army Acquisition Objective
<b>AAR</b>	After Action Review
<b>AARTS</b>	Army / American Council on Education Registry Transcript System
<b>AASA</b>	Administrative Assistant to the Secretary of the Army
<b>ABC</b>	Activity Based Costing
<b>ABC-C</b>	Army Benefits Center-Civilian
<b>ABCTMP</b>	Army Brigade Combat Team Modernization Program
<b>ABO</b>	Army Budget Office
<b>AC</b>	Advanced Course
<b>AC</b>	Active Component
<b>ACAP</b>	Army Career and Alumni Program
<b>ACAT</b>	Army Acquisition Category
<b>ACC</b>	Army Capstone Concept
<b>ACC</b>	Army Competitive Category
<b>ACC</b>	Army Community Covenant
<b>ACC</b>	Army Contracting Command
<b>ACC</b>	Army Corrections Command
<b>ACD</b>	Accelerated Capabilities Division
<b>ACE-IT</b>	Army Corps of Engineers Information Technology
<b>ACES</b>	Army Continuing Education System
<b>ACF</b>	Army Concept Framework
<b>ACOE</b>	Army Community of Excellence
<b>ACOM</b>	Army Command
<b>ACP</b>	Army Campaign Plan (The Army Plan (TAP), Part 5)
<b>ACP</b>	Army Cost Position
<b>ACR</b>	Advanced Concepts and Requirements
<b>ACR</b>	Armored Cavalry Regiment
<b>ACRB</b>	Army Cost Review Board
<b>AC / RC</b>	Active / Reserve Component



<b>ACS</b>	Army Community Service
<b>ACSIM</b>	Assistant Chief of Staff for Installation Management
<b>ACT</b>	Army Career Tracker
<b>ACTEDS</b>	Army Civilian Training, Education, and Development System
<b>ADA</b>	Air Defense Artillery
<b>ADA</b>	Anti-Deficiency Act
<b>ADCON</b>	Administrative Control
<b>ADDIE</b>	Analyze, Design, Develop, Implement and Evaluate
<b>ADL</b>	Active Duty List
<b>ADM</b>	Acquisition Decision Memorandum
<b>ADOS</b>	Active Duty for Operational Support
<b>ADP</b>	Army Doctrine Publication
<b>ADR</b>	Alternative Dispute Resolution
<b>ADRP</b>	Army Doctrine Reference Publication
<b>ADS</b>	Authoritative Data Source
<b>ADSO</b>	Active Duty Service Obligation
<b>ADT</b>	Academic Degree Training
<b>ADT</b>	Active Duty for Training
<b>ADTLP</b>	Army Doctrine and Training Literature Program
<b>ADVON</b>	Advanced Echelon
<b>AE</b>	Active Enlisted
<b>AEA</b>	Army Enterprise Architecture
<b>AECA</b>	Arms Export Control Act
<b>AE2S</b>	Army Equipping Enterprise System
<b>AEF</b>	American Expeditionary Force
<b>AEMS</b>	Army Equipment Modernization Strategy
<b>AEP</b>	Army Experimentation Plan
<b>AEPI</b>	Army Environmental Policy Institute
<b>AER</b>	Academic Evaluation Report
<b>AESIP</b>	Army Enterprise System Integration Program
<b>AEWRS</b>	Army Energy and Water Report System
<b>AFAMC</b>	Air Force Air Mobility Command
<b>AFARS</b>	Army Federal Acquisition Regulation Supplement
<b>AFC</b>	Army Functional Concept
<b>AFCS</b>	Active Federal Commissioned Service
<b>AFHC</b>	Army Family Housing (Construction)
<b>AFHO</b>	Army Family Housing (Operations)
<b>AFHSC</b>	Armed Forces Health Surveillance Center
<b>AFM</b>	Army Flow Model

## HOW THE ARMY RUNS

<b>AFMS</b>	Army Force Management School
<b>AFPD</b>	Available Force Pool Date
<b>AFR</b>	Agency Financial Report
<b>AFS</b>	Active Federal Service
<b>AFS</b>	Army Facility Strategy
<b>AFSB</b>	Army Field Support Brigade
<b>AFSC</b>	Army Facilities Standardization Committee
<b>AG-1 CP</b>	Assistant G-1 for Civilian Personnel
<b>AGR</b>	Active Guard Reserve
<b>AGTS</b>	Advanced Gunnery Training System
<b>AHLTA</b>	Armed Forces Healthcare Longitudinal Application
<b>AHS</b>	U.S. Army Headquarters Services
<b>AHS</b>	Army Health System
<b>A&amp;ID</b>	Analysis and Integration Directorate
<b>AIM</b>	Acquisition Information Management
<b>AIP</b>	Assignment Incentive Pay
<b>AIS</b>	Automated Information Systems
<b>AIT</b>	Advanced Individual Training
<b>AIT</b>	Automatic Identification Technologies
<b>AJ</b>	Administrative Judge
<b>AKEA</b>	Army Knowledge Enterprise Architecture
<b>AKO</b>	Army Knowledge Online
<b>ALC</b>	Advanced Leaders Course
<b>ALCMC</b>	Army Learning Content Management Capability
<b>ALDS</b>	Army Leader Development Strategy
<b>ALM</b>	Adult Learning Model / Army Learning Model
<b>ALMS</b>	Army Learning Management System
<b>ALO</b>	Authorized Level of Organization
<b>AM2020CP</b>	Army Medicine 2020 Campaign Plan
<b>AMA</b>	Analysis of Materiel / Non-Materiel Approaches
<b>AMAG</b>	Army Management Action Group
<b>AMC</b>	Army Materiel Command
<b>AMC</b>	Air Mobility Command
<b>AMCB</b>	Army Marine Corps Board
<b>AMCMOPES</b>	Army Materiel Command (AMC) Mobilization and Operation Planning and Execution System
<b>AMCOM</b>	Aviation and Missile Command
<b>AMCS</b>	Army Mission Command System
<b>AME</b>	Assigned Mission Equipment

<b>AMEDD</b>	Army Medical Department
<b>AMEDDC&amp;S</b>	Army Medical Department Center and School
<b>AMET</b>	Agency Mission-Essential Task
<b>AMETL</b>	Assigned Mission Essential Task List
<b>AMHA</b>	Army Management Headquarters Activities
<b>AMLE</b>	Army Medical Logistics Enterprise
<b>AMM</b>	Assigned Mission Manning
<b>AMP</b>	Army Modernization Plan
<b>AMRDEC</b>	Aviation & Missile Research, Development, and Engineer Center
<b>AMRB</b>	Army Mission Essential Task List (METL) Review Board
<b>AMRG</b>	Army Marketing and Research Group
<b>AMS</b>	Army Management Structure
<b>AMS</b>	Army Mobilization System (replaced AMOPES)
<b>AMSCO</b>	Army Management Structure Code
<b>AMSH</b>	Army Medicine System for Health
<b>AMSP</b>	Advanced Military Studies Program
<b>AMT</b>	Army Modernization Training
<b>ANAD</b>	Anniston Army Depot
<b>ANC</b>	Arlington National Cemetery
<b>ANC</b>	Army Nurse Corps
<b>ANNPRO</b>	Annual Program
<b>ANS</b>	Activity, Nutrition and Sleep
<b>AO</b>	Active Officer
<b>AO</b>	Area of Operation
<b>AO / AE</b>	Active Officer / Active Enlisted
<b>AoA</b>	Analysis of Alternatives
<b>AOC</b>	Area of Concentration
<b>AOC</b>	Army Operating Concept
<b>AOCC</b>	Analysis of Change Cell
<b>AODC</b>	Action Officer Development Course
<b>AOI</b>	Area of Interest
<b>AOLCM</b>	Army Organizational Life Cycle Model
<b>AOR</b>	Area of Responsibility
<b>AOS</b>	Army Organization Server
<b>APAC</b>	U.S. Army Public Affairs Center
<b>APB</b>	Acquisition Program Baseline
<b>APD</b>	Army Publishing Directorate
<b>APE</b>	Army Program Elements
<b>APEX</b>	Adaptive Planning and Execution

## HOW THE ARMY RUNS

<b>APF</b>	Appropriated Fund
<b>APFT</b>	Army Physical Fitness Test
<b>APGM</b>	Army Program Guidance Memorandum (The Army Plan (TAP) Part 4)
<b>APLDF</b>	Army Profession and Leader Development Forum
<b>APOD</b>	Aerial Port of Debarkation
<b>APG</b>	Army Planning Guidance (The Army Plan (TAP) Part 3)
<b>APP</b>	Army Protection Program
<b>APP</b>	Army Protective Posture
<b>APPN</b>	Appropriation
<b>APR</b>	Annual Performance Report
<b>APRB</b>	Army Requirements Oversight Council (AROC) Process Review Board
<b>APS</b>	Army Posture Statement
<b>APS</b>	Army Pre-Positioned Stocks
<b>APUC</b>	Average Procurement Unit Cost
<b>AR</b>	Army Regulation
<b>AR2B</b>	Army Requirements and Resourcing Board
<b>ARADS</b>	Army Recruiting and Accession Data System
<b>ARB</b>	Army Resources Board
<b>ARBA</b>	Army Review Boards Agency
<b>ARCIC</b>	Army Capabilities Integration Center
<b>ARCOM</b>	Army Reserve Command
<b>ARDEC</b>	U.S. Army Armament Research, Development and Engineering Center
<b>AREF</b>	Army Reserve Expeditionary Force
<b>AREP</b>	Army Reserve Expeditionary Package
<b>ARFPC</b>	Army Reserve Forces Policy Committee
<b>ARL</b>	Army Research Laboratory
<b>ARMS</b>	Armament Retooling and Manufacturing Support Program
<b>ARMS</b>	Army Readiness Management System
<b>ARNG</b>	Army National Guard
<b>AROC</b>	Army Requirements Oversight Council
<b>ARPA</b>	Advanced Research Projects Agency
<b>ARPRINT</b>	Army Program for Individual Training
<b>ARSEC</b>	Army Secretariat
<b>ARSTAF</b>	Army Staff
<b>ARSTRAT</b>	Army Strategic Command
<b>ARSTRUC</b>	Army Structure
<b>ARTCP</b>	Army Reserve Transformation Campaign Plan
<b>ARTEP</b>	Army Training and Evaluation Program
<b>AS</b>	Acquisition Strategy

<b>ASA(ALT)</b>	Assistant Secretary of the Army for Acquisition, Logistics, and Technology
<b>ASA(CW)</b>	Assistant Secretary of the Army for Civil Works
<b>ASA(FM&amp;C)</b>	Assistant Secretary of the Army for Financial Management and Comptroller
<b>ASA(IE&amp;E)</b>	Assistant Secretary of the Army for Installations, Energy and Environment
<b>ASA(M&amp;RA)</b>	Assistant Secretary of the Army for Manpower and Reserve Affairs
<b>ASARC</b>	Army Systems Acquisition Review Council
<b>ASAT</b>	Automated Systems Approach to Training
<b>ASB</b>	Army Science Board
<b>ASB</b>	Aviation Support Battalion
<b>ASC</b>	Acquisition Support Center
<b>ASC</b>	Army Sustainment Command
<b>ASCC</b>	Army Service Component Command
<b>ASD(HA)</b>	Assistant Secretary of Defense (Health Affairs)
<b>ASD(HD&amp;ASA)</b>	Assistant Secretary of Defense for Homeland Defense and America's Security Affairs
<b>ASD(RA)</b>	Assistant Secretary of Defense (Reserve Affairs)
<b>ASD(SO / LIC)</b>	Assistant Secretary of Defense for Special Operations / Low Intensity Conflict
<b>ASD(PA)</b>	Assistant Secretary of Defense (Public Affairs)
<b>ASI</b>	Additional Skill Identifier
<b>ASIOEP</b>	Associated Support Items of Equipment and Personnel
<b>ASIP</b>	Army Stationing and Installation Plan
<b>ASK</b>	Assignment Satisfaction Key
<b>ASL</b>	Authorized Stockage List
<b>ASLDP</b>	Army Senior Leader Development Program
<b>ASLSP</b>	Advanced Strategic Leadership Studies Program
<b>ASORTS</b>	Army Status of Resources and Training System
<b>ASOS</b>	Army Support to Other Services
<b>ASP</b>	Army Strategic Plan (The Army Plan (TAP) Part 2)
<b>ASRA</b>	Army Strategic Readiness Assessment
<b>AST</b>	Army Test and Evaluation Command System Team
<b>ASTAG</b>	Army Science and Technology Advisory Group
<b>ASTMP</b>	Army Science and Technology Master Plan
<b>ASTWG</b>	Army Science and Technology Working Group
<b>ASVAB</b>	Armed Services Vocational Aptitude Battery
<b>ASV</b>	Armored Security Vehicle
<b>AT</b>	Annual Training
<b>AT&amp;L</b>	Acquisition, Technology, and Logistics
<b>ATA</b>	Additional Training Assembly
<b>ATC</b>	Army Training Center
<b>ATD</b>	Advanced Technology Demonstration

## HOW THE ARMY RUNS

<b>ATDC</b>	Army Training Development Capability
<b>A TEC</b>	U.S. Army Test and Evaluation Command
<b>ATED</b>	Army Training and Education
<b>ATFP</b>	Army Total Force Policy
<b>ATIA</b>	Army Training Information Architecture
<b>ATIS</b>	Army Training Information System
<b>ATLDC</b>	Army Training and Leader Development Conference
<b>ATLDP</b>	Army Training and Leader Development Panel
<b>ATMC</b>	Army Training Management Capability
<b>ATN</b>	Army Training Network
<b>ATO</b>	Army Technology Objectives
<b>ATO(D)</b>	Advance Technology Objectives (Demonstration)
<b>ATO(M)</b>	Army Technology Objectives (Manufacturing Technology)
<b>ATO(R)</b>	Advance Technology Objectives (Research)
<b>ATRRS</b>	Army Training Requirements and Resources System
<b>ATRM</b>	Aviation Training Resource Model
<b>ATS</b>	Army Training Strategy
<b>ATSC</b>	Army Training Support Center
<b>ATTP</b>	Army Tactics, Techniques and Procedures
<b>AUGTDA</b>	Augmentation Table of Distribution and Allowances
<b>AUJTL</b>	Army Universal Joint Task List
<b>AUS / RA</b>	Army of the U.S. / Regular Army
<b>AUSA</b>	Association of the U.S. Army
<b>AUTH</b>	Authorization
<b>AUTL</b>	Army Universal Task List
<b>AUTS</b>	Automatic Update Transaction System
<b>AV</b>	Army Vision (The Army Plan (TAP) Part 1)
<b>AW</b>	Asymmetric Warfare
<b>AWCF</b>	Army Working Capital Fund
<b>AWE</b>	Advanced Warfighting Experiment
<b>AWFC</b>	Army Warfighting Challenge
<b>BA</b>	Budget Activity
<b>BA</b>	Budget Authority
<b>BAG</b>	Budget Activity Group
<b>BAH</b>	Basic Allowance for Housing
<b>BASOPS</b>	Base Operations
<b>BBS</b>	Brigade-Battalion Battle Simulation
<b>BC</b>	Basic Course
<b>BCA</b>	Budget Control Act

<b>BCP</b>	Budget Change Proposal
<b>BCT</b>	Basic Combat Training
<b>BCT</b>	Brigade Combat Team
<b>BCTP</b>	Battle Command Training Program
<b>BEA</b>	Business Enterprise Architecture
<b>BES</b>	Budget Estimate Submission
<b>BH</b>	Behavioral Health
<b>BIDE</b>	Basic Identity Data Elements
<b>BIDS</b>	Biological Integrated Detection System
<b>BLCSE</b>	Battle Lab Collaborative Simulation Environment
<b>BLIN</b>	Budget Line Item Number
<b>BLTM</b>	Battalion Level Training Model
<b>BMC</b>	Brigade Modernization Command
<b>BMDR</b>	Ballistic Missile Defense Review
<b>BMIS-T</b>	Battlefield Medical Information-Theater
<b>BOD</b>	Board of Directors
<b>BOD</b>	Broadcast Operations Detachment
<b>BOG</b>	Boots on Ground
<b>BOIP</b>	Basis of Issue Plan
<b>BOIPFD</b>	Basis of Issue Plan Feeder Data
<b>BOLC</b>	Basic Officer Leaders Course
<b>BOS</b>	Base Operations Support
<b>BOS</b>	Budget Operating Systems
<b>BOS</b>	Business Operating System
<b>BPLAN</b>	Base Plan
<b>BR</b>	Budget Review
<b>BRAC</b>	Base Realignment and Closure
<b>BRM</b>	Base Operations Support (BOS) Requirements Model
<b>BRP</b>	Budget Requirements & Programs
<b>BSA</b>	Budget Sub-Activity
<b>BSB</b>	Brigade Support Battalion
<b>BSI</b>	Base Support Installation
<b>BT</b>	Basic Training
<b>BTOE</b>	Base Table of Organization and Equipment
<b>BUR</b>	Bottom Up Review
<b>BY</b>	Budget Fiscal Year
<b>C2</b>	Command and Control
<b>C3I</b>	Command, Control, Communications, and Intelligence
<b>C4</b>	Command, Control, Communications, and Computers

## HOW THE ARMY RUNS

<b>C4IM</b>	Command, Control, Communications, and Information
<b>C4ISR</b>	Command, Control, Communications, Computers, Intelligence, Surveillance, and Reconnaissance
<b>CAA</b>	U.S. Center for Army Analysis
<b>CAC</b>	Combined Arms Center
<b>CAC</b>	Common Access Card
<b>CAE</b>	Component Acquisition Executive
<b>CAIG</b>	Cost Analysis Improvement Group
<b>CAIV</b>	Cost as an Independent Variable
<b>CALL</b>	Center for Lessons Learned
<b>CAM</b>	Combined Arms Maneuver
<b>CAMS</b>	Capabilities and Army Requirements Oversight Council (AROC) Management System
<b>CAP</b>	Crisis Action Planning
<b>CAP</b>	Critical Acquisition Position
<b>CAPDEV</b>	Capability Developer
<b>CAPE</b>	Cost Assessment and Performance Evaluation
<b>CAR</b>	Chief, Army Reserve
<b>CARD</b>	Cost Analysis Requirements Description
<b>CARDS</b>	Catalog of Approved Requirements Documents
<b>CASCOM</b>	Combined Arms Support Command
<b>CATS</b>	Combined Arms Training Strategy
<b>CBA</b>	Cost-Benefit Analysis
<b>CBARB</b>	Cost-Benefit Analysis Review Board
<b> CBDRT</b>	Chemical-Biological Defense Readiness Training
<b>CBIRF</b>	Chemical Biological Incident Response Force (USMC)
<b>CBM</b>	Condition Based Maintenance
<b>CBRN</b>	Chemical, Biological, Radiological, and Nuclear
<b>CBRNE</b>	Chemical, Biological, Radiological, Nuclear, and High-Yield Explosives
<b>CBS</b>	Corps Battle Simulation
<b>CBV</b>	Capability-Based Volunteer
<b>CBTDEV</b>	Combat Developer
<b>CBWTU</b>	Community-Based Warrior Transition Unit
<b>CCA</b>	Clinger-Cohen Act
<b>CCC</b>	Captains Career Course
<b>CCC</b>	Combat Casualty Care
<b>CCAD</b>	Corpus Christi Army Depot
<b>CCDR</b>	Combatant Commander
<b>CCDOR</b>	Combatant Commander's Daily Operational Requirements
<b>CCJO</b>	Capstone Concept for Joint Operations



<b>CCMD</b>	Combatant Command (Organization)
<b>CCP</b>	Concept Capability Plan
<b>CCTT</b>	Close Combat Tactical Trainer
<b>CD&amp;E</b>	Concept Development and Experimentation
<b>CDA</b>	Capability Demand Analysis
<b>CDD</b>	Capability Development Document
<b>CDID</b>	Capability Development Integration Directorate
<b>CDLD</b>	Concept Development and Learning Directorate
<b>CDO</b>	Chief Data Officer
<b>CDO</b>	Civil Disturbance Operations
<b>CDPL</b>	Command Designated Positional List
<b>CDR</b>	Critical Design Review
<b>CDRT</b>	Capability Development for Rapid Transition
<b>CDTM</b>	Capability Development Tracking and Management
<b>CE</b>	Continuous Evaluation
<b>CECOM</b>	Communications-Electronics Command (Life Cycle Management Command (LCMC))
<b>CEF</b>	Contingency Expeditionary Force
<b>CER</b>	Cost Estimating Relationship
<b>CERFP</b>	Chemical, Biological, Radiological, Nuclear, and High-Yield Explosives (CBRNE) Enhanced Response Force Package
<b>CES</b>	Civilian Education System
<b>CESL</b>	Continuing Education for Senior Leaders
<b>CEW</b>	Civilian Expeditionary Workforce
<b>CF</b>	Conventional Force
<b>CFLCC</b>	Coalition Forces Land Component Command
<b>CFMO</b>	Construction and Facility Management Officer
<b>CFO</b>	Chief Financial Officer
<b>CFR</b>	Code of Federal Regulations
<b>CFSC</b>	Community and Family Support Center
<b>CG</b>	Commanding General
<b>CG CAP</b>	Coast Guard Capabilities Plan
<b>CGA</b>	Capabilities Gap Assessment
<b>CGSOC</b>	Command and General Staff Officer Course
<b>CHES</b>	Computers, Hardware, and Enterprise Software Services
<b>CHR</b>	Civilian Human Resource
<b>CHRA</b>	U.S. Army Civilian Human Resources Agency
<b>CHRTAS</b>	Civilian Human Resource Training Application System
<b>CIA</b>	Central Intelligence Agency
<b>CIC</b>	Critical Intelligence Category

## HOW THE ARMY RUNS

<b>C-IED</b>	Counter-Improvised Explosive Devise
<b>CIO</b>	Chief Information Officer
<b>CIP</b>	Contract in Process
<b>CIPMS</b>	Civilian Intelligence Personnel Management System
<b>CIPPS</b>	Civilian Integration into the Personnel Proponent System
<b>CIS</b>	Comptroller Information System
<b>CJA</b>	Comprehensive Joint Assessment
<b>CJCS</b>	Chairman of the Joint Chiefs of Staff
<b>CJCSI</b>	Chairman of the Joint Chiefs of Staff Instruction
<b>CJCSM</b>	Chairman of the Joint Chiefs of Staff Memorandum
<b>C&amp;L</b>	Capabilities and Limitations
<b>CLO</b>	Consolidated Legal Office
<b>CLS</b>	Common Levels of Support
<b>CLS SSP</b>	Common Levels of Support (CLS) Service Support Program (SSP)
<b>C-MNS</b>	Combat-Mission Need Statement
<b>CM</b>	Current Month
<b>CM</b>	Command Manager
<b>CM</b>	Consequence Management
<b>CM</b>	Cost Management
<b>CMA</b>	Chemical Materials Agency
<b>CMEP</b>	Civil-Military Emergency Planning
<b>CMETL</b>	Core Mission Essential Task List
<b>CMF</b>	Career Management Field
<b>CM(FS)</b>	Command Manager (Force Structure)
<b>CMH</b>	U.S. Army Center of Military History
<b>CMICS</b>	Civilian Manpower Integrated Costing System
<b>CMO</b>	Chief Management Officer
<b>CNA</b>	Capability Needs Analysis
<b>CNGB</b>	Chief, National Guard Bureau
<b>COA</b>	Course of Action
<b>COCOM</b>	Combatant Command (Command Authority)
<b>CoC</b>	Council of Colonels
<b>CoE</b>	Center of Excellence
<b>COE</b>	Chief of Engineers
<b>COE</b>	Contemporary Operational Environment
<b>COFT</b>	Conduct of Fire Trainer
<b>COG</b>	Continuity of Government
<b>COIC</b>	Critical Operational Issues and Criteria
<b>COIN</b>	Counterinsurgency

<b>COIST</b>	Company Intelligence Support Team
<b>COL</b>	Colonel
<b>COLS</b>	Common Output Level Standards
<b>COMCAM</b>	Combat Camera
<b>COMPASS</b>	Computerized Movement Planning and Status System
<b>COMPO</b>	Component
<b>CONARC</b>	Continental Army Command
<b>CONOPS</b>	Concept of Operations
<b>CONPLAN</b>	Concept Plan
<b>CONPLAN</b>	Contingency Plan
<b>CONUS</b>	Continental U.S.
<b>CONUSA</b>	Continental U.S. Army
<b>COOP</b>	Continuity of Operations / Continuity of Operations Plan
<b>CORTRAIN</b>	Corps and Division Training Coordination Program
<b>COTS</b>	Commercial Off The Shelf
<b>CP</b>	Change Proposals
<b>CPA</b>	Chairman's Program Assessment
<b>CPA</b>	Chief of Public Affairs
<b>CPAC</b>	Civilian Personnel Advisory Center
<b>CPD</b>	Capability Production Document
<b>CPD</b>	Competitive Professional Development
<b>CPI</b>	Critical Program Information
<b>CPIM</b>	Capital Planning and Investment Management
<b>CPLAN</b>	Command Plan
<b>CPMD</b>	Command Provost Marshal Directorate
<b>CPOL</b>	Civilian Personnel Online Library
<b>CPP</b>	Cost & Performance Portal
<b>CPPP</b>	Caregiving Personnel Pay Program
<b>CPR</b>	Chairman's Program Recommendation
<b>CPR</b>	Capability Portfolio Review
<b>CPX</b>	Command Post Exercise
<b>CRA</b>	Chairman's Risk Assessment
<b>CRA</b>	Continuing Resolution Authority
<b>CRB</b>	Cost Review Board
<b>CRC</b>	Continental U.S. (CONUS) Replacement Center
<b>CREL</b>	Cultural, Regional, and Language
<b>CREST</b>	Contingency Real Estate Support Teams
<b>CRM</b>	Composite Risk Management
<b>CrM</b>	Crisis Response Management

## HOW THE ARMY RUNS

<b>CROWS</b>	Common Remote Operated Weapons System
<b>CRS</b>	Chairman's Readiness System
<b>CRXXI</b>	Classroom Twenty One
<b>C / S / A</b>	Combatant Command, Service, and Combat Support Agency (CSA)
<b>CS</b>	Civil Support
<b>CS</b>	Combat Support
<b>CSA</b>	Chief of Staff, U.S. Army
<b>CSA</b>	Combat Support Agency
<b>CSB</b>	Configuration Steering Board
<b>CSB</b>	Continental U.S. (CONUS) Support Base
<b>CSDJF</b>	Chairman's Strategic Direction to the Joint Force
<b>CSL</b>	Centralized Selection List
<b>CSLMO</b>	Civilian Senior Leader Management Office
<b>CSM</b>	Command Sergeant Major
<b>CSM</b>	Capability Set Management
<b>CSRA</b>	Civil Service Reform Act
<b>CSS</b>	Combat Service Support
<b>CSSB</b>	Combat Sustainment Support Battalion
<b>CST</b>	Civil Support Team
<b>CSTC</b>	Combat Support Training Center
<b>CSTX</b>	Combat Support Training Exercise
<b>CTC</b>	Combat Training Center
<b>CTE</b>	Critical Technology Element
<b>CTE</b>	Culminating Training Event
<b>CTS</b>	Contingency Tracking System
<b>CTT</b>	Collective Training Task
<b>CUSR</b>	Commander's Unit Status Report
<b>CWMD</b>	Counter Weapons of Mass Destruction (WMD)
<b>CWT</b>	Civilian Workforce Transformation
<b>CXO</b>	Chief Integration Officer
<b>CY</b>	Calendar Year
<b>CYPPP</b>	Child and Youth Personnel Pay Program
<b>DA</b>	Department of the Army
<b>DA PAM</b>	Department of the Army Pamphlet
<b>DAB</b>	Defense Acquisition Board
<b>DAB</b>	Director of the Army Budget
<b>DAC</b>	Department of the Army Civilian
<b>DACIL</b>	Department of the Army Critical Items List
<b>DACM</b>	Director, Acquisition Career Management

<b>DAE</b>	Defense Acquisition Executive
<b>DAES</b>	Defense Acquisition Executive Summary
<b>DAGO</b>	Department of the Army General Order
<b>DAGR</b>	Defense Advanced Global Positioning System (GPS) Receiver
<b>DALSO</b>	Department of the Army Logistics Support Officer
<b>DAMPS</b>	Department of the Army Mobilization Processing System
<b>DANTES</b>	Defense Activity for Non-Traditional Education Support
<b>DAO</b>	Defense Accounting Office
<b>DARNG</b>	Director, Army National Guard
<b>DARPA</b>	Defense Advanced Research Projects Agency
<b>DARPL</b>	Dynamic Army Resourcing Priority List
<b>DAS</b>	Defense Acquisition System
<b>DAS</b>	Director of the Army Staff
<b>DASA</b>	Deputy Assistant Secretary of the Army
<b>DASA(C&amp;E)</b>	Deputy Assistant Secretary of the Army for Cost and Economics
<b>DASA(DE&amp;C)</b>	Deputy Assistant Secretary of the Army for Defense Exports and Cooperation
<b>DASA(DL)</b>	Deputy Assistant Secretary of the Army for Diversity and Leadership
<b>DASA(E&amp;S)</b>	Deputy Assistant Secretary of the Army for Energy and Sustainability
<b>DASA(ESOH)</b>	Deputy Assistant Secretary of the Army for Environment, Safety, and Occupational Health
<b>DASA(FO)</b>	Deputy Assistant Secretary of the Army for Financial Operations
<b>DASA(IH&amp;P)</b>	Deputy Assistant Secretary of the Army for Installations, Housing, and Partnerships
<b>DASA(R&amp;T)</b>	Deputy Assistant Secretary of the Army for Research and Technology
<b>DASA(SI)</b>	Deputy Assistant Secretary of the Army for Strategic Integration
<b>DASC</b>	Department of the Army System Coordinator
<b>DASD(CPP)</b>	Deputy Under Secretary of Defense for Civilian Personnel Policy
<b>DASD(IP)</b>	Deputy Assistant Secretary of Defense for Industrial Policy
<b>DAU</b>	Defense Acquisition University
<b>DAWIA</b>	Defense Acquisition Workforce Improvement Act
<b>DBS</b>	Defense Business System
<b>DBSMC</b>	Defense Business System (DBS) Management Council
<b>DC</b>	Dental Corps
<b>DCE</b>	Defense Coordinating Element
<b>DCG / CofS</b>	Deputy Commanding General / Chief of Staff
<b>DCI</b>	Director, Central Intelligence
<b>DICR</b>	Doctrine, Organization, Training, Materiel, Leadership and Education, Personnel, Facilities, and Policy (DOTMLPF-P) Integrated Change Recommendation
<b>DCIPS</b>	Defense Casualty Information Processing System
<b>DCIPS</b>	Defense Civilian Intelligence Personnel System
<b>DCLM</b>	Department of Command, Leadership, and Management

## HOW THE ARMY RUNS

<b>DCMA</b>	Defense Contract Management Agency
<b>DCO</b>	Defense Coordinating Officer
<b>DCPAS</b>	Defense Civilian Personnel Advisory Services
<b>DCPDS</b>	Defense Civilian Personnel Data System
<b>DCR</b>	Doctrine, Organization, Training, Materiel, Leadership and Education, Personnel, Facilities, and Policy (DOTMLPF-P) Change Recommendation
<b>DCS</b>	Deputy Chief of Staff
<b>DCSOPS</b>	Deputy Chief of Staff, Operations
<b>DCU</b>	Defense Coordinating Unit
<b>DD</b>	Department of Defense (Form)
<b>DDASS</b>	Department of Defense Support to Civil Authorities, Automated Support System
<b>DDFP</b>	Deputy Director, Force Protection
<b>DDN</b>	Defense Data Network
<b>DDR</b>	Deputy Director Requirement
<b>DDS</b>	Dynamic Distribution System
<b>DDOT</b>	Deputy Director of Training
<b>DDTC</b>	Deployed Digital Training Campus
<b>DEA</b>	Drug Enforcement Administration
<b>DEF</b>	Deployment Expeditionary Force
<b>DELDP</b>	Defense Executive Leadership Development Program
<b>DENCOM</b>	Dental Command
<b>DENTAC</b>	Dental Activity
<b>DEOMI</b>	Defense Equal Opportunity Management Institute
<b>DEPORD</b>	Deployment Order
<b>DEPSECDEF</b>	Deputy Secretary of Defense
<b>DEROS</b>	Date Eligible to Return from Overseas
<b>DES</b>	Directorate of Emergency Services
<b>DEST</b>	Domestic Emergency Support Team (FBI)
<b>DET</b>	Displaced Equipment Training
<b>DFARS</b>	Defense Federal Acquisition Regulation Supplement
<b>DFAS</b>	Defense Finance and Accounting Service
<b>DFAS-IN</b>	Defense Finance and Accounting Service-Indiana
<b>DFCU</b>	Defense Planning & Coordination Unit
<b>DFM</b>	Director of Force Management
<b>DFMWR</b>	Directorate of Family, Morale, Welfare & Recreation
<b>DG</b>	Defense Guidance
<b>DHHS</b>	Department of Health and Human Services
<b>DHP</b>	Defense Health Program
<b>DHR</b>	Directorate of Human Resources

<b>DHS</b>	Director of Health Services
<b>DHS</b>	Department of Homeland Security
<b>DI</b>	Document Integrator
<b>DIA</b>	Defense Intelligence Agency
<b>DIEMS</b>	Date Initially Entered Military Service
<b>DIRLAUTH</b>	Direct Authority
<b>DISA</b>	Defense Information Systems Agency
<b>DISES</b>	Defense Intelligence Senior Executive Service
<b>DISL</b>	Defense Intelligence Senior Level
<b>DJI</b>	Director of Joint & Integration (Force Development Directorate)
<b>DKO</b>	Defense Knowledge Online
<b>dL</b>	Distance Learning
<b>dLC</b>	Distance Learning Classrooms
<b>dLS</b>	Distance Learning System
<b>DL</b>	Distributed Learning
<b>DLA</b>	Defense Logistics Agency
<b>DLE</b>	Defense Liaison Element
<b>DLEA</b>	Drug Law Enforcement Agency
<b>DLMP</b>	Doctrine and Literature Master Plan
<b>DLS</b>	Distributed Learning System
<b>DMA</b>	Defense Media Activity
<b>DMAG</b>	Deputy's Management Action Group
<b>DMAT</b>	Disaster Medical Assistance Team
<b>DMC</b>	Distribution Management Center
<b>DMETL</b>	Directed Mission Essential Task List
<b>DML / DMSL</b>	Distribution Management Level / Sub-Level
<b>DMLSS</b>	Defense Medical Logistics Standard Support
<b>DMO</b>	Directed Military Overstrength
<b>DMORT</b>	Disaster Mortuary Operational Response Team
<b>DMP</b>	Director of Manpower and Personnel
<b>DMSS</b>	Defense Medical Surveillance System
<b>DMSSC</b>	Defense Medical Systems Support Center
<b>DOC</b>	Department of Commerce
<b>DOC DEV</b>	Document Developer
<b>DOD</b>	Department of Defense
<b>DOD(B)</b>	Department of Defense Budget
<b>DODD</b>	Department of Defense Directive
<b>DODI</b>	Department of Defense Instruction
<b>DOD IRD</b>	Department of Defense Investigations and Resolutions Division

## HOW THE ARMY RUNS

<b>DOE</b>	Department of Energy
<b>DOJ</b>	Department of Justice
<b>DOL</b>	Directorate of Logistics
<b>DOM</b>	Director of Materiel (Force Development Directorate)
<b>DOPMA</b>	Defense Officer Personnel Management Act
<b>DOR</b>	Director of Resources (Force Development Directorate)
<b>DOS</b>	Department of State
<b>DOT</b>	Department of Transportation
<b>DOT</b>	Director of Training
<b>D,OT&amp;E</b>	Director, Operational Test and Evaluation
<b>DOTmLPF-P</b>	Doctrine, Organization, Training, Leadership and Education, Personnel, Facilities, and Policy (Non-Materiel)
<b>DOTMLPF-P</b>	Doctrine, Organization, Training, Materiel, Leadership and Education, Personnel, Facilities, and Policy
<b>DPAE</b>	Director of Program Analysis and Evaluation
<b>DPAS</b>	Defense Priorities and Allocations System
<b>DPC</b>	Defense Planning and Coordination
<b>DPCU</b>	Defense Planning and Coordination Unit
<b>DPD</b>	Defense Programming Database
<b>DPG</b>	Defense Planning Guidance
<b>DPP</b>	Dedicated Procurement Program
<b>DPS</b>	Defense Planning Scenarios
<b>DPTMS</b>	Directorate of Plans, Training, Mobilization and Security
<b>DPW</b>	Directorate of Public Works
<b>DRB</b>	Defense Resources Board
<b>DRF</b>	Disaster Relief Fund
<b>DRMO</b>	Defense Reutilization and Marketing Office
<b>DRRS</b>	Defense Readiness Reporting System
<b>DRRS-A</b>	Defense Readiness Reporting System-Army
<b>DRU</b>	Direct Reporting Unit
<b>DS</b>	Direct Support
<b>DSAT</b>	Department of Homeland Security (DHS) Situational Awareness Team
<b>DSCA</b>	Defense Security Cooperation Agency
<b>DSCA</b>	Defense Support of Civil Authorities
<b>DSG</b>	Defense Strategic Guidance
<b>DSLDP</b>	Defense Senior Leader Management Program
<b>DSMC</b>	Defense Systems Management College
<b>DSR</b>	Defense Strategy Review (previously Quadrennial Defense Review (QDR))
<b>DST</b>	Decision Support Tool
<b>DT</b>	Developmental Test



<b>DTAC</b>	Digitized Training Access Center
<b>DTF</b>	Digital Training Facility
<b>DTG</b>	Date Time Group
<b>DTMS</b>	Digital Training Management System
<b>DTOE</b>	Draft Table of Organization and Equipment
<b>DTOS</b>	Deployable Tracking Operations System
<b>DTR</b>	Defense Transportation Regulation
<b>DTRA</b>	Defense Threat Reduction Agency
<b>DTS</b>	Defense Transportation System
<b>DTT</b>	Doctrine and Tactics Training
<b>DUSD(AS&amp;C)</b>	Deputy Under Secretary of Defense (Advanced Systems and Concepts)
<b>DUSD(AT&amp;L)</b>	Under Secretary of Defense (Acquisition, Technology, and Logistics)
<b>DUSD(S&amp;T)</b>	Deputy Undersecretary of Defense (Science and Technology)
<b>DVIDS</b>	Defense Video and Imagery Distribution System
<b>E2E</b>	End to End
<b>EA</b>	Economic Analysis
<b>EAB</b>	Echelons Above Brigade
<b>EB</b>	Executive Board
<b>EBIS</b>	Employee Benefits Information System
<b>ECAS</b>	Environmental Compliance Assessment System
<b>ECC</b>	Expeditionary Contracting Command
<b>ECG</b>	Enduring Constitutional Government
<b>ECOP</b>	Equipping Common Operating Picture
<b>ECP</b>	Engineering Change Proposal
<b>ECQ</b>	Executive Core Qualifications
<b>EDA</b>	Excess Defense Articles
<b>EDAS</b>	Enlisted Distribution and Assignment System
<b>EDATE</b>	Effective Date
<b>EDM</b>	Engineering Development Model
<b>EDTM</b>	Enlisted Distribution Target Model
<b>EE</b>	Equipping (Program Evaluation Group (PEG))
<b>E-E</b>	Emergency Essential
<b>EEO</b>	Equal Employment Office
<b>EEO</b>	Equal Employment Opportunity
<b>EEOC</b>	Equal Employment Opportunity Commission
<b>EEOCCR</b>	Equal Employment Opportunity Compliance and Complaints Review
<b>EES</b>	Enlisted Evaluation System
<b>EFD</b>	Enterprise Funds Distribution
<b>EFMP</b>	Exceptional Family Member Program

## HOW THE ARMY RUNS

<b>EG</b>	Enlisted Grade
<b>EIS</b>	Enterprise Information System
<b>EIS</b>	Enterprise Infrastructure Services
<b>EITF</b>	Energy Initiatives Task Force
<b>EL</b>	Environmental Liability
<b>ELC</b>	Executive Leaders Course
<b>EMAC</b>	Emergency Management Assistance Compact
<b>EMD</b>	Engineering and Manufacturing Development
<b>eMILPO</b>	Electronic Military Personnel Office
<b>EMP</b>	Emergency Management Program
<b>EMS</b>	Emergency Medical Services
<b>EO</b>	Equal Opportunity
<b>EO</b>	Executive Order
<b>EOA</b>	Equal Opportunity Advisor
<b>EOC</b>	State Emergency Operation Center
<b>EOD</b>	Explosive Ordnance Disposal
<b>EOL</b>	Equal Opportunity Leader
<b>EOPM</b>	Equal Opportunity Program Manager
<b>EOR</b>	Element of Resource
<b>EO WH</b>	Executive Office White House
<b>EPAERT</b>	Environmental Protection Agency Environmental Response Team
<b>EPLO</b>	Emergency Preparedness Liaison Officer
<b>EPMD</b>	Enlisted Personnel Management Directorate
<b>EPMS</b>	Enlisted Personnel Management System
<b>EPMS-AR</b>	Enlisted Personnel Management System-Army Reserve
<b>EPP</b>	Enhanced Planning Process
<b>EPP</b>	Extended Planning Period
<b>EPW</b>	Enemy Prisoners of War
<b>EQ4</b>	Equip the Force (AE2S)
<b>ERB</b>	Executive Resources Board
<b>ERC</b>	Equipment Readiness Code
<b>ERDC</b>	U.S. Army Engineer Research and Development Center
<b>ERGO</b>	Environmental Review Guide for Operations
<b>ERP</b>	Enterprise Resource Planning
<b>ERT</b>	Evidence Response Team (FBI)
<b>ES</b>	Embedded Simulation
<b>ES</b>	End Strength
<b>ES</b>	Enlisted Specialty
<b>ESC</b>	Expeditionary Sustainment Command

<b>ESD</b>	Equipment Sourcing Document
<b>ESF</b>	Emergency Support Function
<b>ESGR</b>	National Committee for Employer Support of the Guard and Reserve
<b>ESLRG</b>	Expanded Senior Review Group
<b>ESP</b>	Executive and Senior Professional
<b>ETC</b>	Exportable Training Capability
<b>ETS</b>	Expiration of Term of Service
<b>ETM</b>	Enterprise Talent Management
<b>EUCOM</b>	U.S. European Command
<b>EUSA</b>	Eighth U.S. Army
<b>EW</b>	Electronic Warfare
<b>EXEC</b>	Execution
<b>EXCOM</b>	Executive Committee
<b>EXORD</b>	Execute Order
<b>F2025&amp;B</b>	Force 2025 & Beyond
<b>FA</b>	Functional Area
<b>FA-TRAC</b>	Foreign Army Training Assistance Command
<b>FAA</b>	Final Agency Action
<b>FAA</b>	Functional Area Analysis
<b>FAD</b>	Final Agency Decision
<b>FAD</b>	Fund Authorization Document
<b>FADM</b>	Force Allocation Decision Model
<b>FAR</b>	Federal Acquisition Regulation
<b>FASCLASS</b>	Fully Automated System for Classification
<b>FbA</b>	Formation-Based Assessment
<b>FBI</b>	Federal Bureau of Investigation
<b>FC</b>	Foundation Course
<b>FCB</b>	Functional Capabilities Board
<b>FCCE</b>	Flood Control and Coastal Emergencies
<b>FCO</b>	Federal Coordinating Officer
<b>FDA</b>	Food and Drug Administration
<b>FDD</b>	Force Design Division
<b>FDIIS</b>	Force Development Investment Information System (AE2S)
<b>FDO</b>	Flexible Deterrent Option
<b>FDTE</b>	Force Development Tests and Experimentation
<b>FDU</b>	Force Design Update
<b>FEA</b>	Front End Analysis
<b>FECA</b>	Federal Employees Compensation Act
<b>FEMA</b>	Federal Emergency Management Agency

## HOW THE ARMY RUNS

<b>FFC</b>	Fact Finding Conference
<b>FFE</b>	Field Force Engineering
<b>FFMIA</b>	Federal Financial Management Improvement Act
<b>FFR</b>	Force Feasibility Review
<b>FG</b>	Fiscal Guidance
<b>FHP</b>	Force Health Protection
<b>FI</b>	Force Integrator
<b>FIFA</b>	Force Integration Functional Area
<b>FIRST</b>	Federal Incident Response Support Team
<b>FIS</b>	Facility Investment Strategy
<b>FLRA</b>	Federal Labor Relations Authority
<b>FM</b>	Field Manual
<b>FM</b>	Force Management
<b>FMCS</b>	Federal Mediation and Conciliation Service
<b>FMFIA</b>	Federal Manager's Financial Integrity Act
<b>FMR</b>	Financial Management Regulation Table
<b>FMR</b>	Force Management Review
<b>FMR</b>	Full Materiel Release
<b>FMS</b>	Force Management System
<b>FMS</b>	Foreign Military Sales
<b>FMSWeb</b>	Force Management System (FMS) Web
<b>FMT</b>	Foreign Military Training
<b>FMWR</b>	Family and Morale, Welfare, and Recreation
<b>FMWRC</b>	Family and Morale, Welfare, and Recreation Command
<b>FNA</b>	Functional Needs Analysis
<b>FOA</b>	Field Operating Agency
<b>FOA</b>	Forward Operational Assessment
<b>FOC</b>	Full Operational Capability
<b>FOIA</b>	Freedom of Information Act
<b>FORMDEPS</b>	Forces Command Mobilization and Deployment Planning System
<b>FORSCOM</b>	U.S. Army Forces Command
<b>FoS</b>	Family of Systems
<b>FOT&amp;E</b>	Follow-on Operational Test and Evaluation
<b>FOUO</b>	For Official Use Only
<b>FP</b>	Force Protection
<b>FPMS</b>	Flood Plain Management Services Program
<b>FPPM</b>	Functional Proponent for Preventive Medicine
<b>FR</b>	Functional Review
<b>FRC</b>	Federal Resource Coordinator

<b>FRP</b>	Full Rate Production
<b>FS</b>	Force Structure
<b>FSA</b>	Force Structure Allowance
<b>FSA</b>	Functional Solution Analysis
<b>FSBP</b>	First Sergeant's Barracks Program
<b>FSIP</b>	Federal Service Impasses Panel
<b>FSM</b>	Facility Sustainment Model
<b>FTN</b>	Force Tracking Number
<b>FTS</b>	Full Time Support
<b>FTSTDA</b>	Full Time Support Table of Distribution and Allowances
<b>FTX</b>	Field Training Exercises
<b>FUDS</b>	Formerly Used Defense Site
<b>FUE</b>	First Unit Equipped
<b>FWS</b>	Federal Wage System
<b>FY</b>	Fiscal Year
<b>FYDP</b>	Future Years Defense Program
<b>G-3 / 7 FM</b>	G-37 Force Management
<b>GAO</b>	Government Accountability Office
<b>GAR</b>	Governor's Authorized Representative
<b>GC</b>	General Counsel
<b>GC</b>	Garrison Commander
<b>GCC</b>	Geographic Combat Command
<b>GCCS</b>	Global Command and Control System
<b>GCMCA</b>	General Court Martial Convening Authority
<b>GCSS-A (F / T)</b>	Global Combat Service Support System Army (Field / Tactical)
<b>GCV</b>	Ground Combat Vehicle
<b>GDF</b>	Guidance for Development of the Force
<b>GDPRS</b>	Global Defense Posture Realignment Strategy
<b>GDPS</b>	Global Defense Posture Strategy
<b>GEF</b>	Guidance for Employment of the Force
<b>GF</b>	Generating Force
<b>GFEBs</b>	General Fund Enterprise Business System
<b>GFM</b>	Global Force Management
<b>GFMAP</b>	Global Force Management Allocation Plan
<b>GFMB</b>	Global Force Management Board
<b>GFM DI</b>	Global Force Management Data Initiative
<b>GFMIG</b>	Global Force Management Implementation Guidance
<b>GFT</b>	Games for Training
<b>GIE</b>	Global Information Environment

## HOW THE ARMY RUNS

<b>GIG</b>	Global Information Grid
<b>GINA</b>	Genetic Information Nondiscrimination Act
<b>GIWW</b>	Gulf Intracoastal Waterway
<b>GMRA</b>	Government Management Reform Act
<b>GO</b>	General Officer
<b>GO</b>	General Order
<b>GOSC</b>	General Officer Steering Committee
<b>GPF</b>	General Purpose Forces
<b>GPP</b>	Graduate Placement Program
<b>GPRA</b>	Government Performance and Results Act
<b>GRD</b>	Grade
<b>GRF</b>	Global Response Force
<b>GS</b>	General Schedule
<b>GSA</b>	General Services Administration
<b>GSORTS</b>	Global Status of Resources and Training System
<b>HA</b>	Humanitarian Assistance
<b>HAAP</b>	Homebase / Advanced Assignment Program
<b>HASC</b>	House Armed Services Committee
<b>HCM</b>	Human Capital Management
<b>HD</b>	Homeland Defense
<b>HEAT</b>	High-Mobility Multipurpose Wheeled Vehicle (HMMWV) Egress Assistance Trainer
<b>HEPLO</b>	Headquarters Emergency Preparedness Liaison Officer
<b>HFEA</b>	Human Factors Engineering Analysis
<b>HHA</b>	Health Hazard Assessment
<b>HHC / HHD</b>	Headquarters and Headquarters Company / Headquarters and Headquarters Detachment
<b>HHS</b>	Health and Human Services
<b>HIV</b>	Human Immunodeficiency Virus
<b>HLT</b>	Hurricane Liaison Team
<b>HMRU</b>	Hazardous Material Response Unit (FBI)
<b>HN</b>	Host Nation
<b>HNS</b>	Host Nation Support
<b>HP&amp;RR</b>	Health Promotion & Risk Reduction
<b>HQ</b>	Headquarters
<b>HQDA</b>	Headquarters, Department of the Army
<b>HQE</b>	Highly Qualified Expert
<b>HQIMCOM</b>	Headquarters, Installation Management Command
<b>HR</b>	Human Resources
<b>HRC</b>	Human Resources Command

<b>HRCoE</b>	Health Readiness Center of Excellence
<b>HRC-STL</b>	Human Resources Command-St Louis
<b>HRD</b>	Human Resources Development
<b>HRF</b>	Homeland Response Force
<b>HRM</b>	Human Resource Management
<b>HRT</b>	Hostage Rescue Team (FBI)
<b>HS</b>	Homeland Security
<b>HSC</b>	Homeland Security Council
<b>HSDRRS</b>	Hurricane and Storm Damage Risk Reduction System
<b>HSI</b>	Human Systems Integration
<b>HSPD</b>	Homeland Security Presidential Directive
<b>HSS</b>	Health Service Support
<b>HTAR</b>	How The Army Runs
<b>IA</b>	Individual Account
<b>IA</b>	Individual Augmentation
<b>IA</b>	Information Assurance
<b>IADT</b>	Initial Active Duty for Training
<b>IAEMP</b>	Interagency Emergency Management Program
<b>IAPM</b>	Information Assurance Program Manager
<b>IAW</b>	In Accordance With
<b>IC</b>	Incident Commander
<b>IC</b>	Intermediate Course
<b>ICAF</b>	Industrial College of the Armed Forces
<b>ICD</b>	Initial Capabilities Document
<b>ICDT</b>	Integrated Capabilities Development Team
<b>ICE</b>	Independent Life-Cycle Cost Estimate
<b>ICO</b>	Installation Contractor Office
<b>ICP</b>	Inventory Control Point
<b>ICPA</b>	Injury Compensation Program Administrator
<b>ICS</b>	Incident Command System
<b>ICT</b>	Integrated Concept Team
<b>ICW</b>	In Coordination With
<b>ICW</b>	In Compliance With
<b>IDP</b>	Individual Development Plan
<b>IDT</b>	Inactive Duty Training
<b>IE</b>	Integration Evaluation
<b>IEMP</b>	Integrated Emergency Management Plan
<b>IET</b>	Initial Entry Training
<b>IG</b>	Inspector General

## HOW THE ARMY RUNS

<b>IGI&amp;S</b>	Installation Geospatial Information & Services
<b>IGO</b>	Intergovernmental Organization
<b>IGSA</b>	Intergovernmental Support Agreement
<b>II</b>	Installations (Program Evaluation Group (PEG))
<b>IIQ</b>	Initial Issue Quantity
<b>ILE</b>	Intermediate Level Education
<b>ILO</b>	In Lieu Of
<b>ILS</b>	Integrated Logistics Support
<b>ILSM</b>	Integrated Logistic Support Manager
<b>IM</b>	Information Management
<b>IMA</b>	Individual Mobilization Augmentee
<b>IMA</b>	Installation Management Agency
<b>IMAT</b>	Incident Management Assistance Team
<b>IMBOD</b>	Installation Management Board of Directors
<b>IMC</b>	Installation Management Community
<b>IMCOM</b>	U.S. Army Installation Management Command
<b>IMD</b>	Integrated Missile Defense
<b>IMET</b>	International Military Education and Training
<b>IMI</b>	Interactive Multimedia Instruction
<b>IMO</b>	Information Management Office
<b>IMRD</b>	Intelligence Resource Management Decision
<b>IMS</b>	Integrated Management System
<b>IMS</b>	International Military Student
<b>IMT</b>	Initial Military Training
<b>INFOSEC</b>	Information Security
<b>ING</b>	Inactive National Guard
<b>INSCOM</b>	U.S. Army Intelligence and Security Command
<b>IOC</b>	Initial Operational Capability
<b>IOT</b>	Initial Operational Test
<b>IOTE</b>	Initial Operational Testing and Evaluation
<b>IP</b>	Individual Permit
<b>IP</b>	Installation Preparedness
<b>IP</b>	Issue Paper
<b>IPA</b>	Integrated Program Assessment
<b>IPL</b>	Integrated Priority List
<b>IPMO</b>	Intelligence Personnel Management Office
<b>IPM</b>	Industrial Preparedness Measure
<b>IPP</b>	Industrial Preparedness Planning
<b>IPPL</b>	Industrial Preparedness Planning



<b>IPR</b>	In-Process Review
<b>IPR-A</b>	In-Process Review-Strategic Guidance
<b>IPR-C</b>	In-Process Review-Concept Development
<b>IPR-F</b>	In-Process Review-Plan Approval
<b>IPRG</b>	Intelligence Program Review Group
<b>IPR-R</b>	In-Process Review-Plan Assessment
<b>IPS</b>	Integrated Product Support
<b>IPT</b>	Integrated Process Team
<b>IPT</b>	Integrated Product Team
<b>IR</b>	Integration Rehearsal
<b>IR</b>	Irregular Warfare
<b>IRACO</b>	Internal Review and Audit Compliance Office
<b>IR&amp;D</b>	Independent Research and Development
<b>IRD</b>	Investigation and Resolutions Division
<b>IRR</b>	Individual Ready Reserve
<b>ISC</b>	Integrated Security Campaign
<b>ISEW</b>	Intelligence, Security, and Electronic Warfare
<b>ISMA</b>	Installation Support Management Activity
<b>ISO</b>	Installation Safety Office
<b>ISP</b>	Information Support Plan
<b>ISR</b>	Installation Status Report
<b>ISR</b>	Intelligence, Surveillance, and Reconnaissance
<b>IT</b>	Information Technology
<b>ITA</b>	U.S. Army Information Technology Agency
<b>ITAB</b>	Information Technology Acquisition Board
<b>ITAEDP</b>	Integrated Total Army Equipment Distribution Program
<b>ITAPBD</b>	Integrated Total Army Personnel Data Base
<b>ITAM</b>	Integrated Training Area Management
<b>ITD</b>	Individual Training Directorate
<b>ITE</b>	Integrated Training Environment
<b>ITMRA</b>	Information Technology Management Reform Act of 1996
<b>ITP</b>	Individual Training Plan
<b>ITR</b>	Individual Training Record
<b>ITRM</b>	Individual Training Resource Module
<b>ITTP</b>	Institutional Training Technology Program
<b>ITV</b>	In-Transit Visibility
<b>IW</b>	Irregular Warfare
<b>IWR</b>	Institute for Water Resources
<b>JAGC</b>	Judge Advocate General's Corps

## HOW THE ARMY RUNS

<b>JBIG</b>	Joint Base Implementation Guidance
<b>JC</b>	Joint Concept
<b>JCA</b>	Joint Capability Area
<b>JCB</b>	Joint Capabilities Board
<b>JCCA</b>	Joint Combat Capability Assessment
<b>JCCAG</b>	Joint Combat Capability Assessment Group
<b>JCCA-PA</b>	Joint Combat Capability Assessment-Plan Assessment
<b>JCD</b>	Joint Capabilities Document
<b>JCD&amp;E</b>	Joint Concept Development and Experimentation
<b>JCIDS</b>	Joint Capabilities Integration and Development System
<b>JCLL</b>	Joint Center for Lessons Learned
<b>JCRM</b>	Joint Capabilities Requirements Manager
<b>JCS</b>	Joint Chiefs of Staff
<b>JCTD</b>	Joint Capabilities Technology Demonstration
<b>JDOMS</b>	Joint Directorate of Military Support
<b>JEON</b>	Joint Emerging Operation Need
<b>JFC</b>	Joint Force Commander
<b>JFCC ISR</b>	Joint Functional Component Command for Intelligence, Surveillance, and Reconnaissance (ISR)
<b>JFHQ-NCR</b>	Joint Force Headquarters-National Capital Region
<b>JFHQ-State</b>	Joint Forces Headquarters-State
<b>JFLCC</b>	Joint Forces Land Component Command
<b>JFO</b>	Joint Field Office (FBI)
<b>JFP</b>	Joint Force Provider
<b>JFM</b>	Joint Force Manager
<b>JFRR</b>	Joint Force Readiness Review
<b>JFSC</b>	Joint Forces Staff College
<b>JIA</b>	Joint Individual Augmentee
<b>JIC</b>	Joint Information Center
<b>JIEDDO</b>	Joint Improvised Explosive Devices Defeat Organization
<b>JIIM</b>	Joint, Interagency, Intergovernmental, and Multinational
<b>JLTV</b>	Joint Light Tactical Vehicle
<b>JMC</b>	Joint Munitions Command
<b>JMD</b>	Joint Manning Document
<b>JMET</b>	Joint Mission Essential Task
<b>JMETL</b>	Joint Mission Essential Task List
<b>JM&amp;L</b>	Joint Munitions and Lethality (Life Cycle Management Command (LCMC))
<b>JMRC</b>	Joint Multinational Readiness Center
<b>JC</b>	Joint Concepts

<b>JCB</b>	Joint Capabilities Board
<b>JOA</b>	Joint Operations Area
<b>JOC</b>	Joint Operations Center
<b>JOE</b>	Joint Operating Environment
<b>JOIN</b>	Joint Optical Information System
<b>JOPEs</b>	Joint Operations Planning and Execution System
<b>JOPP</b>	Joint Operation Planning Process
<b>JP</b>	Joint Publication
<b>JPAC</b>	Joint Planning Augmentation Cell
<b>JPEC</b>	Joint Planning and Execution Community
<b>JRAC</b>	Joint Rapid Acquisition Cell
<b>JROC</b>	Joint Requirements Oversight Council
<b>JROCM</b>	Joint Requirements Oversight Council Memorandum
<b>JROTC</b>	Junior Reserve Officer Training Corps
<b>JRTC</b>	Joint Readiness Training Center
<b>JS</b>	Joint Staff
<b>JSCP</b>	Joint Strategic Capabilities Plan
<b>JSD</b>	Joint Staffing Designator
<b>JSO</b>	Joint Specialty Officer
<b>JSOTF</b>	Joint Special Operations Task Force
<b>JSPS</b>	Joint Strategic Planning System
<b>JSR</b>	Joint Strategy Review
<b>JTA / JTD</b>	Joint Table of Authorizations / Joint Table of Distribution
<b>JTAPIC</b>	Joint Trauma Analysis and Prevention of Injury in Combat Program
<b>JTC</b>	Joint Commission
<b>JTF</b>	Joint Task Force
<b>JTF-CS</b>	Joint Task Force-Civil Support
<b>JTF-N</b>	Joint Task Force-North
<b>JTF-PO</b>	Joint Task Force-Port Opening
<b>JTRS</b>	Joint Tactical Radio System
<b>JULLS</b>	Joint Utilization Lesson Learned System
<b>JUON</b>	Joint Urgent Operational Need
<b>JWE</b>	Joint Warfighting Experiment
<b>JWSTAP</b>	Joint Weapon Safety Technical Advisory Panel
<b>KD</b>	Key Developmental
<b>KFL</b>	Key Facilities List
<b>KM / DS</b>	Knowledge Management / Decision Support
<b>KPP</b>	Key Performance Parameter
<b>KSA</b>	Key System Attribute

## HOW THE ARMY RUNS

<b>LAD</b>	Latest Arrival Date
<b>LAN</b>	Local Area Network
<b>LAP</b>	Logistics Assistance Program
<b>LCMC</b>	Life Cycle Management Command
<b>LCSP</b>	Life Cycle Sustainment Plan
<b>LEA</b>	Law Enforcement Agency
<b>LEAD</b>	Letterkenny Army Depot
<b>LFA</b>	Lead Federal Agency
<b>LFT</b>	Live First Testing
<b>LFT&amp;E</b>	Live Fire Test and Evaluation
<b>LHWCA</b>	Longshore and Harbor Workers Compensation Act
<b>LIA</b>	Logistics Innovation Agency
<b>LIC</b>	Language Identification Code
<b>LIN</b>	Line Item Number
<b>LIO</b>	Limited Intervention Operations
<b>LIRA</b>	Long-Range Investment Requirements Analysis
<b>LIW</b>	Logistics Information Warehouse
<b>LMER</b>	Labor and Management Employee Relations
<b>LMI</b>	Lead Materiel Integrator
<b>LMI</b>	Logistics Management Information
<b>LMP</b>	Logistics Management Program
<b>LOB</b>	Lines of Business
<b>LOC</b>	Lines of Communication
<b>LOD</b>	Line of Duty
<b>LOE</b>	Line of Effort
<b>LOGCAP</b>	Logistics Civil Augmentation Program
<b>LOGSA</b>	Logistics Support Activity
<b>LOGSACS</b>	Logistics Structure and Composition System
<b>LOI</b>	Letter of Instruction
<b>LOO</b>	Line of Operation
<b>LRIP</b>	Low Rate Initial Production
<b>LTC</b>	Lieutenant Colonel
<b>LVC</b>	Live, Virtual, Constructive
<b>LVCG</b>	Live, Virtual, Constructive, and Gaming
<b>LWN</b>	LandWarNet
<b>M&amp;S</b>	Modeling and Simulation
<b>M2PR</b>	Monthly Military Personnel Review
<b>MA</b>	Mission Assurance
<b>MA</b>	Mortuary Affairs

<b>MACA</b>	Military Assistance to Civil Authorities
<b>MACDIS</b>	Military Assistance for Civil Disturbance
<b>MACOM</b>	Major Army Command
<b>MAIS</b>	Major Automated Information System
<b>MAISRC</b>	Major Automated Information System Review Council
<b>MANPRINT</b>	Manpower and Personnel Integration
<b>MARC</b>	Manpower Requirements Criteria
<b>MAST</b>	Military Assistance to Safety and Traffic
<b>MATDEV</b>	Materiel Developer
<b>MBI</b>	Major Budget Issue
<b>MC</b>	Medical Corps
<b>MC</b>	Mission Command
<b>MC4</b>	Medical Communications for Combat Casualty Care
<b>MCA</b>	Military Construction, Army
<b>MCAR</b>	Military Construction, Army Reserve
<b>MCASP</b>	Mission Command Art and Sciences Program
<b>MCCP</b>	Marine Corps Capabilities Plan
<b>MCD</b>	Materiel Capabilities Document
<b>MCNG</b>	Military Construction, Army National Guard
<b>MCO</b>	Major Combat Operations
<b>MCS</b>	Managed Care Support
<b>MCTP</b>	Mission Command Training Program
<b>MCTSP</b>	Mission Command Training Support Program
<b>MCU</b>	Multiple Component Unit
<b>MDA</b>	Missile Defense Agency
<b>MDA</b>	Milestone Decision Authority
<b>MDAP</b>	Major Defense Acquisition Program
<b>MDC</b>	Manager Development Course
<b>MDD</b>	Materiel Development Decision
<b>MDEP</b>	Management Decision Execution Package
<b>MDLC</b>	Mobile Distributed Learning Center
<b>MDR</b>	Milestone Decision Review
<b>MDW</b>	Military District of Washington
<b>ME</b>	Materiel Enterprise
<b>MEDCEN</b>	Medical Center
<b>MEDCOM</b>	Medical Command
<b>MEDDAC</b>	Medical Department Activity
<b>MEDLOG</b>	Medical Logistics
<b>MEO</b>	Military Equal Opportunity

## HOW THE ARMY RUNS

<b>MEPCOM</b>	Military Entrance Processing Command
<b>MEPS</b>	Military Entrance Processing Station
<b>MER</b>	Manpower Estimate Report
<b>MER</b>	Mission Essential Requirements
<b>MERS</b>	Mobile Emergency Response Support
<b>MET</b>	Mission Essential Task
<b>METL</b>	Mission Essential Task List
<b>METT-TC</b>	Mission, Enemy, Terrain and Weather, Troops and Support Available, Time Available, and Civilians Considerations
<b>MFA</b>	Materiel Fielding Agreement
<b>MFE</b>	Maneuver, Fires, and Effects
<b>MFORCE</b>	Master Force
<b>MFP</b>	Materiel Fielding Plan
<b>MFTB</b>	Multifunctional Training Brigade
<b>MHA</b>	Management Headquarters Account
<b>MHRM</b>	Military Human Resource Management
<b>MHS</b>	Military Health System
<b>MIC</b>	Managers Internal Control
<b>MID</b>	Management Initiative Decisions
<b>MILCON</b>	Military Construction
<b>MILDEP</b>	Military Department
<b>MILDEP</b>	Military Deputy
<b>MILPERS</b>	Military Personnel
<b>MILS</b>	Military Supply
<b>MILSPEC / STD</b>	Military Specifications and Standards
<b>Mil-Tech</b>	Military Technician
<b>MILVAX</b>	Military Vaccine
<b>MIPS</b>	Modified Integrated Program Summary
<b>MLMC</b>	Medical Logistics Management Center
<b>MM</b>	Manning (Program Evaluation Group (PEG))
<b>MMDF</b>	Maintenance Master Data File
<b>MMEWR</b>	Minimum Mission Essential Wartime Requirement
<b>MMG</b>	Master Mobilization Guide
<b>MOA</b>	Memorandum of Agreement
<b>MOB ARPRINT</b>	Mobilization Army Program for Individual Training
<b>MOBMAN</b>	Mobilization Manpower Planning System
<b>MOBTDA</b>	Mobilization Table of Distribution and Allowances
<b>MOC</b>	Media Operations Center
<b>MOCS</b>	Military Occupational Classification and Structure

<b>MOD</b>	Modernization
<b>MOE</b>	Measures of Effectiveness
<b>MOI</b>	Memorandum of Instruction
<b>MOS</b>	Military Occupational Specialty
<b>MOS-T</b>	Military Occupational Specialty Training
<b>MOSLS</b>	Military Occupational Specialty Level System
<b>MOSQ</b>	Military Occupational Specialty Qualified
<b>MOU</b>	Memorandum of Understanding
<b>MPA</b>	Military Personnel, Army
<b>MPAD</b>	Mobile Public Affairs Detachment
<b>MPLAN</b>	Marine Corps Mobilization Management Plan
<b>MPS</b>	Mobilization Planning System
<b>MPT</b>	Manpower, Personnel, and Training
<b>MRAP</b>	Mine Resistant Ambush Protected Vehicle
<b>MRD</b>	Material Requirements Document
<b>MRL</b>	Materiel Requirements List
<b>MRMC</b>	Medical Research and Material Command
<b>MRO</b>	Maintenance Repair and Overhaul
<b>MS</b>	Milestone
<b>MS</b>	Medical Service Corps
<b>MSA</b>	Materiel Solution Analysis
<b>MSC</b>	Military Sealift Command
<b>MSC</b>	Major Subordinate Command
<b>MSCLEA</b>	Military Assistance to Civil Law Enforcement Agencies
<b>MSFD</b>	Multi-Service Force Development
<b>MSO</b>	Military Service Obligation
<b>MSP</b>	Mission Support Plan
<b>MSPB</b>	Merit Systems Protection Board
<b>MSU</b>	Mobilization Support Unit
<b>MTBF</b>	Mean Time Between Failure
<b>MTF</b>	Military Treatment Facility
<b>MTOE</b>	Modified Table of Organization and Equipment
<b>MTP</b>	Master Training Plan
<b>MTP</b>	Mission Training Plan
<b>MTT</b>	Mobile Training Team
<b>MUA</b>	Military Utility Assessment
<b>MUTA</b>	Multiple Unit Training Assembly
<b>MUTA-4</b>	Multiple Unit Training Assemblies-Four Consecutive Assemblies)
<b>MWR</b>	Morale, Welfare, and Recreation

## HOW THE ARMY RUNS

<b>MYR</b>	Mid-Year Review
<b>NAF</b>	Non-Appropriated Funds
<b>NAFI</b>	Non-Appropriated Funds Instrumentalities
<b>NAP</b>	Not Authorized Prepositioning
<b>NASA</b>	National Aeronautics and Space Administration
<b>NATO</b>	North Atlantic Treaty Organization
<b>NC</b>	Nurse Corps
<b>NCA</b>	National Command Authority
<b>NCE</b>	Non-Combat Essential
<b>NCMP</b>	Navy Capabilities and Mobilization Plan
<b>NCO</b>	Noncommissioned Officer
<b>NCOA</b>	Noncommissioned Officer Academy
<b>NCOER</b>	Noncommissioned Officer Evaluation Report
<b>NCOES</b>	Noncommissioned Officer Education System
<b>NDA</b>	National Defense Act
<b>NDAA</b>	National Defense Authorization Act
<b>NDI</b>	Non-Developmental Item
<b>NDMS</b>	National Disaster Medical System
<b>NDS</b>	National Defense Stockpile
<b>NEC</b>	Network Enterprise Center
<b>NEO</b>	Non-Combatant Evacuation Operations
<b>NEPA</b>	National Environmental Policy Act of 1969
<b>NEST</b>	Nuclear Emergency Support Team
<b>NET</b>	New Equipment Training
<b>NETCOM</b>	Network Enterprise Technology Command
<b>NETP</b>	New Equipment Training Plan
<b>NETT</b>	New Equipment Training Team
<b>NetUSR</b>	Net-Centric Unit Status Report
<b>NFIP</b>	National Flood Insurance Program
<b>NFIP</b>	National Foreign Intelligence Program
<b>NGB</b>	National Guard Bureau
<b>NGO</b>	Nongovernmental Organization
<b>NGPA</b>	National Guard Personnel, Army
<b>NGREA</b>	National Guard and Reserve Equipment Appropriation
<b>NGS</b>	Non-Government Standards
<b>NIE</b>	Network Integrated Evaluation
<b>NIFC</b>	National Interagency Fire Center
<b>NIMS</b>	National Incident Management System
<b>NIR</b>	Network Integration Rehearsal



<b>NIRT</b>	Nuclear Incident Response Team
<b>NMA-GOSC</b>	Network Mission Area General Officer Steering Committee
<b>NMRTS</b>	National Medical Response Teams
<b>NMS</b>	National Military Strategy
<b>NMUSA</b>	National Museum of the U.S. Army
<b>NOAA</b>	National Oceanic and Atmospheric Administration
<b>NOC</b>	National Operations Center
<b>NOF</b>	Notional Force
<b>NOFC</b>	Notification of Future Change
<b>NOK</b>	Next of Kin
<b>NORTHCOM</b>	Northern Command
<b>NP</b>	Neuropsychiatric
<b>NPG</b>	National Preparedness Goal
<b>NPR</b>	Nuclear Posture Review
<b>NPS</b>	Non-Prior Service
<b>NR-KPP</b>	Net-Ready Key Performance Parameter
<b>NRF</b>	National Response Framework
<b>NRP</b>	National Response Plan
<b>NSA</b>	National Security Agency
<b>NSC</b>	National Security Council
<b>NSCS</b>	National Security Council System
<b>NSDD</b>	National Security Decision Directive
<b>NS-E</b>	Non-Standard Equipment
<b>NSN</b>	National Stock Number
<b>NSPS</b>	National Security Personnel System
<b>NSS</b>	National Security Strategy
<b>NSS</b>	National Security System
<b>NSSE</b>	National Special Security Event
<b>NSTD</b>	Non-Standard
<b>NTC</b>	National Training Center
<b>NTV</b>	Non-Tactical Vehicle
<b>NULO</b>	Negative Un-Liquidated Obligations
<b>NVOAD</b>	National Voluntary Organizations Active in Disaster
<b>O / H</b>	On Hand
<b>O / M</b>	Operator and Maintainer
<b>O&amp;M</b>	Operations and Maintenance
<b>O&amp;M(R&amp;M)</b>	Operations and Maintenance (Restoration and Modernization)
<b>O&amp;O</b>	Operational and Organizational
<b>O&amp;R</b>	Oversight and Review

## HOW THE ARMY RUNS

<b>O&amp;S</b>	Operations and Support
<b>OA</b>	Officer Aggregate
<b>OA</b>	Obligation Authority
<b>OA</b>	Operating Agency
<b>OA</b>	Operational Architecture
<b>OA</b>	Operational Availability
<b>OAA</b>	Office of the Administrative Assistant
<b>OACSIM</b>	Office of the Assistant Chief of Staff for Installation Management
<b>OASD</b>	Office of the Assistant Secretary of Defense
<b>OBT</b>	Office of Business Transformation
<b>OE</b>	Operational Environment
<b>OGA</b>	Other Government Agency
<b>OCAR</b>	Office of the Chief, Army Reserve
<b>OCLL</b>	Office, Chief of Legislative Liaison
<b>OCO</b>	Overseas Contingency Operations
<b>OCONUS</b>	Outside of the Continental U.S.
<b>OCPA</b>	Office of the Chief of Public Affairs
<b>OCS</b>	Officer Candidate School
<b>OCS</b>	Operational Contract Support
<b>ODCS</b>	Office of Deputy Chief of Staff
<b>ODP</b>	Officer Distribution Plan
<b>ODS</b>	Officer Development System
<b>ODS</b>	Officer Distribution System
<b>ODT</b>	Overseas Deployment Training
<b>OE</b>	Operational Environment
<b>OEF</b>	Operation Enduring Freedom
<b>OER</b>	Officer Evaluation Report
<b>OES</b>	Officer Education System
<b>OES</b>	Office of Emergency Services
<b>OF</b>	Operating Force
<b>OFM</b>	Officer Forecasting Model
<b>OFO</b>	Office of Federal Operations
<b>OGA</b>	Other Government Agency
<b>OGLA</b>	Officer Grade Limitation Act
<b>OI</b>	Organizational Integrator
<b>OIF</b>	Operation Iraqi Freedom
<b>OIPT</b>	Overarching Integrated Product Team
<b>OJT</b>	On-the-Job Training
<b>OMA</b>	Operations and Maintenance, Army

<b>OMA</b>	Operations and Maintenance Appropriation
<b>OMA\$</b>	Operations and Maintenance Appropriation Dollars
<b>OMAR</b>	Operations and Maintenance, Army Reserve
<b>OMB</b>	Office of Management and Budget
<b>OMNG</b>	Operations and Maintenance, Army National Guard
<b>OMS / MP</b>	Operational Mode Summary / Mission Profiles
<b>OneSAF</b>	One Semi-Automated Forces
<b>ONN</b>	Operational Network Node
<b>ONS</b>	Operational Needs Statement
<b>OO</b>	Organizing (Program Evaluation Group (PEG))
<b>OPA</b>	Officer Personnel Act
<b>OPA</b>	Other Procurement, Army
<b>OPFOR</b>	Opposing Forces
<b>OPLAN</b>	Operations Plan
<b>OPLOC</b>	Operating Location
<b>OPM</b>	Office of Personnel Management
<b>OPMD</b>	Officer Personnel Management Directorate
<b>OPMG</b>	Office of the Provost Marshall General
<b>OPMS</b>	Officer Personnel Management System
<b>OPMS-AR</b>	Officer Personnel Management System-Army Reserve
<b>OPORD</b>	Operation Order
<b>OpSD</b>	Operating Strength Deviation
<b>OPSEC</b>	Operational Security
<b>OPTEMPO</b>	Operating Tempo
<b>ORG DB</b>	Organization (Component of Total Army Personnel Database (TAPDB))
<b>ORB</b>	Officer Record Brief
<b>OS</b>	Operating Strength
<b>OSA</b>	Office of the Secretary of the Army
<b>OSC</b>	Office of Special Counsel
<b>OSD</b>	Office of the Secretary of Defense
<b>OSUT</b>	One Station Unit Training
<b>OT</b>	Operational Testing
<b>OTA</b>	Operational Test Agency
<b>OTA TP</b>	Operational Test Agency Test Plan
<b>OTIG</b>	Office of the Inspector General
<b>OTJAG</b>	Office of the Judge Advocate General
<b>OTOE</b>	Objective Table of Organization and Equipment
<b>OTRA</b>	Other than Regular Army
<b>OTSG</b>	Office of the Surgeon General

## HOW THE ARMY RUNS

<b>OUSD(C)</b>	Office of the Under Secretary of Defense (Comptroller)
<b>P3I</b>	Preplanned Product Improvement
<b>P&amp;D</b>	Production and Deployment
<b>P&amp;R</b>	Personnel and Readiness
<b>PA</b>	Public Affairs
<b>PA&amp;E</b>	Program Analysis and Evaluation
<b>PAA</b>	Procurement Ammunition Army
<b>PAD</b>	Public Affairs Detachment
<b>PAED</b>	Program Analysis and Evaluation Directorate
<b>PAG</b>	Public Affairs Guidance
<b>PAIO</b>	Plans, Analysis & Integration Office
<b>PAO</b>	Public Affairs Officer
<b>PARD</b>	Priorities Analysis and Requirements Directorate
<b>PAUC</b>	Program Acquisition Unit Cost
<b>PB</b>	President's Budget
<b>PBA</b>	Performance-Based Agreements
<b>PBA</b>	Production Base Analysis
<b>PBAS</b>	Program-Budget Accounting System
<b>PBD</b>	Program Budget Decision
<b>PBG</b>	Program and Budget Guidance
<b>PBL</b>	Performance Based Logistics
<b>PBR</b>	Program Budget Review
<b>PC-ASORTS</b>	Personal Computer-Army Status of Resources and Training System
<b>PCA</b>	Posse Comitatus Act of 1878
<b>PCC</b>	Policy Coordination Committee
<b>PCC</b>	Pre-Command Course
<b>PCH</b>	Press Camp Headquarters
<b>PCP</b>	Program Change Proposals
<b>PCS</b>	Permanent Change of Station
<b>PCTEF</b>	Percent Effective
<b>PD</b>	Program Directive
<b>PDASA</b>	Principal Deputy Assistant Secretary of the Army
<b>PDD</b>	Presidential Decision Directive
<b>PDIP</b>	Program Development Increment Package
<b>PDR</b>	Preliminary Design Review
<b>PE</b>	Program Element
<b>PEC</b>	Protection Executive Committee
<b>PED</b>	Processing, Exploitation, and Dissemination
<b>PEG</b>	Program Evaluation Group

<b>PEO</b>	Program Executive Officer
<b>PEO EIS</b>	Program Executive Office Enterprise Information Systems
<b>PEPDUS</b>	Human Resources Command (HRC) Enlisted Personnel Data Update System
<b>PER DB</b>	Personnel (Component of Total Army Personnel Database (TAPDB))
<b>PERMISS</b>	Personnel Management Information and Support System
<b>PERMS</b>	Personnel Electronic Records Management System
<b>PERNET</b>	Personnel Network
<b>PERSACS</b>	Personnel Structure and Composition System
<b>PERSSO</b>	Personnel System Staff Officer
<b>PFA</b>	Personnel Functional Assessment
<b>PfM</b>	Portfolio Management
<b>PFO</b>	Principal Federal Official
<b>PfP</b>	Partnership for Peace
<b>PFY</b>	Prior Fiscal Year
<b>PH</b>	Public Health
<b>PHC</b>	Public Health Command
<b>PI</b>	Product Improvements
<b>PIANC-USA</b>	United States National Section of the World Association for Waterborne Transport Infrastructure
<b>PIM</b>	Pre-Trained Individual Manpower
<b>PIMS</b>	Partnership for Peace (PfP) Information Management System
<b>PKO</b>	Peacekeeping Operations
<b>PL</b>	Public Law
<b>PLANORD</b>	Planning Order
<b>PLL</b>	Prescribed Load List
<b>PM</b>	Program, Project, or Product Manager
<b>PMAD</b>	Personnel Management Authorizations Document
<b>PME</b>	Professional Military Education
<b>PME</b>	Professional Military Exchange
<b>PMF</b>	Presidential Management Fellows
<b>PMG</b>	Provost Marshall General
<b>PMJ</b>	Professional Military Judgment
<b>PMO</b>	Program Management Office
<b>PMS</b>	Personnel Management System
<b>POC</b>	Point of Contact
<b>POD</b>	Point of Delivery
<b>POE</b>	Point of Embarkation
<b>POE</b>	Program Office Estimate
<b>POI</b>	Program of Instruction

## HOW THE ARMY RUNS

<b>POL</b>	Petroleum, Oils, Lubricants
<b>POM</b>	Program Objective Memorandum
<b>POP</b>	Proponency Office for Preventive Medicine
<b>POR</b>	Preparation for Overseas Replacement
<b>POR</b>	Program of Record
<b>POSC-Edit</b>	Personnel Occupational Specialty Code Edit
<b>POSH</b>	Prevention of Sexual Harassment
<b>POTUS</b>	President of the U.S.
<b>PPAG</b>	Proposed Public Affairs Guidance
<b>PPBC</b>	Planning Program Budget Committee
<b>PPBE</b>	Planning, Programming, Budgeting, and Execution
<b>PPBES</b>	Planning, Programming, Budgeting, and Execution System
<b>PPBS</b>	Planning, Programming, and Budgeting System
<b>PPD</b>	Presidential Policy Directive
<b>PPP</b>	Power Projection Platforms
<b>PPV</b>	Public Private Ventures
<b>PQT</b>	Production Qualification Test
<b>PRC</b>	Presidential Reserve Call-Up
<b>PREPO</b>	Pre-Positioned
<b>PRESBUD</b>	President's Budget
<b>PRG</b>	Program Review Group
<b>PROC</b>	Procurement
<b>PROC\$</b>	Procurement Dollars
<b>PROBE</b>	Program Optimization and Budget Evaluation
<b>PROFIS</b>	Professional Officer Filler Information System
<b>PSA</b>	Principal Staff Assistant
<b>PSMA</b>	Pre-Scripted Mission Assignment
<b>PSP</b>	Power Support Platforms
<b>PSS</b>	Product Support Strategy
<b>PURE</b>	Prepositioning Of Materiel Configured in Unit Sets (POMCUS) Unit Residual Equipment
<b>PX</b>	Post Exchange
<b>QA</b>	Quality Assurance
<b>QAO</b>	Quality Assurance Office
<b>QDR</b>	Quadrennial Defense Review (renamed Defense Strategic Review (DSR))
<b>QFR</b>	Question for the Record
<b>QRF</b>	Quick Reaction Force
<b>QMP</b>	Qualitative Management Program
<b>QRM</b>	Quadrennial Roles and Missions Review
<b>QRRC</b>	Quarterly Readiness Report to Congress

<b>QTY</b>	Quantity
<b>R2C</b>	Ready and Resilient Campaign
<b>R&amp;D</b>	Research and Development
<b>RA</b>	Readiness Assessment
<b>RAD</b>	Requirements and Assessment Division
<b>RAD</b>	Research Area Directorates
<b>RAF</b>	Regionally Aligned Forces
<b>RAID</b>	Rapid Assessment and Initial Detection
<b>RAM</b>	Reliability, Availability, and Maintainability
<b>RAP</b>	Revised Approved Program
<b>RAP-C</b>	Requisition Allocation Plan-Continental U.S. (CONUS)
<b>RAR</b>	Rapid Acquisition Review
<b>RAR</b>	Rapid Action Revision
<b>RC</b>	Reserve Component
<b>RC</b>	Required Capabilities
<b>RCAS</b>	Reserve Component Automation System
<b>RCCC</b>	Reserve Component Coordination Council
<b>RCCMRF</b>	Restructured Chemical, Biological, Radiological, Nuclear, and High-Yield Explosives (CBRNE) Consequence Management Response Force
<b>RCI</b>	Residential Communities Initiative
<b>RCP</b>	Retention Control Point
<b>RCSOF</b>	Reserve Component Special Operations Forces
<b>RCTID</b>	Reserve Component Training Integration Directorate
<b>RD</b>	Region Director
<b>RDA</b>	Readiness Deficiency Assessment
<b>RDA</b>	Research, Development, and Acquisition
<b>RDAP</b>	Research, Development, and Acquisition Plan
<b>RDC</b>	Rapid Deployment Capability
<b>RDD</b>	Resource Decision Documents
<b>RDECOM</b>	Research, Development, and Engineering Command
<b>RDL</b>	Reimer Digital Library
<b>RDS</b>	Requirements Documentation System
<b>RDT&amp;E</b>	Research, Development, Test, and Evaluation
<b>RDT&amp;E,A</b>	Research, Development, Test, and Evaluation, Army
<b>RECBASS</b>	Reception Battalion Automated Support System
<b>REF</b>	Rapid Equipping Force
<b>REP-63</b>	Reserve Enlistment Program of 1963
<b>REPLO</b>	Regional Emergency Preparedness Liaison Officer
<b>REQ DB</b>	Requisition (Component of Total Army Personnel Database (TAPDB))

## HOW THE ARMY RUNS

<b>REQUEST</b>	Recruit Quota Enlistment System
<b>RERT</b>	Radiological Emergency Response Team
<b>RETAIN</b>	Reenlistment / Reclassification Assignment System
<b>RFA</b>	Request for Assistance
<b>RFC</b>	Request for Capabilities
<b>RFF</b>	Request for Forces
<b>RFG</b>	Resource Formulation Guide
<b>RFFID</b>	Request for Forces (RFF) Identification Number
<b>RFP</b>	Request for Proposal
<b>RFPB</b>	Reserve Forces Policy Board
<b>RHC</b>	Regional Health Command
<b>RHC-A</b>	Regional Health Command-Atlantic
<b>RHC-C</b>	Regional Health Command-Central
<b>RHC-E</b>	Regional Health Command-East
<b>RHC-P</b>	Regional Health Command-Pacific
<b>RI</b>	Resource Integrator
<b>RIA</b>	Rock Island Arsenal
<b>RID</b>	Requirements Integration Directorate
<b>RIF</b>	Reduction in Force
<b>RIO</b>	Resource-Informed, Focused and Outcome-Based
<b>RMC</b>	Regional Medical Command
<b>RMD</b>	Resource Management Decision
<b>RMD</b>	Requirements Management Division
<b>RMF</b>	Risk Management Framework
<b>RMG</b>	Record Message
<b>RMO</b>	Resource Management Office
<b>ROC</b>	Rehearsal of Concept
<b>ROE</b>	Rules of Engagement
<b>ROI</b>	Report of Investigation
<b>ROMO</b>	Range of Military Operations
<b>ROPMA</b>	Reserve Officer Personnel Management Act
<b>ROTC</b>	Reserve Officers' Training Corps
<b>RPA</b>	U.S. Army Resources and Programs Agency
<b>RPA</b>	Reserve Personnel, Army
<b>RPG</b>	Rocket-Propelled Grenade
<b>RPLANS</b>	Real Property Planning and Analysis System
<b>RRAD</b>	Red River Army Depot
<b>RRCC</b>	Regional Response Coordination Center
<b>RSC</b>	Regional Support Command



<b>RSO</b>	Religious Support Office
<b>RSO</b>	Requirements Staff Officer
<b>RSO</b>	Retirement Services Officer
<b>RTLTP</b>	Range and Training Land Program
<b>RTSM</b>	Regional Training Site Maintenance
<b>RUDIST</b>	REQUEST Unit Distribution Program
<b>RUF</b>	Rules of the Use of Force
<b>S&amp;T</b>	Science and Technology
<b>SA</b>	Security Assistance
<b>SA</b>	Supportability Analysis
<b>SA</b>	Systems Architecture
<b>SAAG</b>	Auditor General of the Army
<b>SAC</b>	Special Agent in Charge (FBI)
<b>SAC</b>	Strategic Air Command
<b>SACEUR</b>	Supreme Allied Commander, Europe
<b>SACS</b>	Structure and Composition System
<b>SAD</b>	State Active Duty
<b>SAMAS</b>	Structure and Manpower Allocation System
<b>SAMS</b>	School of Advanced Military Studies
<b>SAP</b>	Special Access Program
<b>SAPP</b>	Security, Accuracy, Propriety, and Policy
<b>SAPR</b>	Sexual Assault Prevention Response
<b>SAR</b>	Selected Acquisition Report
<b>SAS</b>	Statistical Analysis Software
<b>SASC</b>	Senate Armed Services Committee
<b>SAT</b>	Systems Approach to Training
<b>SATCOM</b>	Satellite Communications
<b>SATD</b>	Security Assistance Training Directorate
<b>SATFA</b>	Security Assistance Training Field Activity
<b>SATP</b>	Security Assistance Training Program
<b>SB</b>	Software Blocking
<b>SB</b>	Supply Bulletin
<b>SB</b>	Sustainment Brigade
<b>SBC</b>	Service Based Costing
<b>SBCT</b>	Stryker Brigade Combat Team
<b>SBIR</b>	Small Business Innovation Research Program
<b>SBP</b>	Survivor Benefit Plan
<b>SBR</b>	Standby Reserve
<b>SC</b>	Senior Commander

## HOW THE ARMY RUNS

<b>SCI</b>	Sensitive Compartmented Information
<b>SCO</b>	State Coordinating Officer
<b>SCRA</b>	Servicemembers Civil Relief Act
<b>SCRAG</b>	Senior Civilian Representative of the Attorney General
<b>SDAP</b>	Special Duty Assignment Pay
<b>SDC</b>	Supervisor Development Course
<b>SDCS</b>	Standard Data Collection System
<b>SDC-EX</b>	Supervisor Development Course for Executives
<b>SDDC</b>	Military Surface Deployment and Distribution Command
<b>SDOB</b>	Secretary of Defense Orders Book
<b>SE</b>	Strategic Effort
<b>SE</b>	Systems Engineering
<b>SE</b>	System Evaluation
<b>SEC</b>	Senior Executive Council
<b>SECARMY</b>	Secretary of the Army
<b>SECDEF</b>	Secretary of Defense
<b>SEHS</b>	Special Events for Homeland Security
<b>SEP</b>	Systems Engineering Plan
<b>SEPLO</b>	State Emergency Preparedness Liaison Officer
<b>SERB</b>	Selective Early Retirement Board
<b>SES</b>	Senior Executive Service
<b>SETM</b>	Senior Enterprise Talent Management
<b>SFC</b>	Sergeant First Class
<b>SfH</b>	System for Health
<b>SFLEO</b>	Senior Federal Law Enforcement Officer
<b>SFL-TAP</b>	Soldier for Life – Transition Assistance Program
<b>SFO</b>	Senior Federal Official
<b>SFRBOD</b>	Soldier and Family Readiness Board of Directors
<b>SG</b>	Standards of Grade
<b>SGO</b>	Standard Garrison Organization
<b>SGM</b>	Sergeant Major
<b>SGS</b>	Strategic Guidance Statement
<b>SGT</b>	Sergeant
<b>SHARP</b>	Sexual Harassment / Assault Response Prevention
<b>SHCP</b>	Strategic Human Capital Planning
<b>SHRM</b>	Strategic Human Resource Management
<b>SICE</b>	Services & Infrastructure Core Enterprise
<b>SIG</b>	Senior Integration Group
<b>SIGINT</b>	Signals Intelligence

<b>SIMLM</b>	Single Integrated Medical Logistics Manager
<b>SIPRNet</b>	Secure Internet Protocol Router Network
<b>SIPT</b>	Supportability Integrated Product Team
<b>SISC</b>	Support for International Sporting Competitions
<b>SKA</b>	Skills, Knowledge, and Attributes
<b>SL</b>	Senior Level
<b>SLAMIS</b>	Standard Study Number (SSN)-Line Item Number (LIN) Automated Management and Integrating System
<b>SLC</b>	Senior Leadership Council
<b>SLC</b>	Senior Leaders Course
<b>SLDA</b>	Senior Leaders of the Department of the Army
<b>SLEP</b>	Service Life Extension Program
<b>SLRG</b>	Senior Leader Review Group
<b>SLS</b>	Senior Leader Seminar
<b>SM</b>	Soldier's Manual
<b>SMART</b>	Special Medical Augmentation Response Team
<b>SMC</b>	Sergeants Major Course
<b>SMCT</b>	Soldier's Manual of Common Tasks
<b>SMDC</b>	Space and Missile Defense Command
<b>SMDR</b>	Structure and Manning Decision Review
<b>SME</b>	Subject Matter Expert
<b>SMSP</b>	Strategic Materials Security Program
<b>SM / TG</b>	Soldier's Manuals / Trainers Guides
<b>SMU</b>	Special Mission Unit
<b>SNaP</b>	Select and Native Programming
<b>SOF</b>	Special Operations Forces
<b>SOFA</b>	Status of Forces Agreement
<b>SOP</b>	Standard Operating Procedure
<b>SoS</b>	System of Systems
<b>SP</b>	Army Medical Specialist Corps
<b>SPOD</b>	Sea Port of Debarkation
<b>SQI</b>	Special Qualification Identifier
<b>SR2R</b>	Service Request to Resolution
<b>SRAG</b>	Strategic Readiness Assessment Group
<b>SRB</b>	Selective Retirement Board
<b>SRC</b>	Standard Requirements Code
<b>SRCA</b>	Service Retained Combatant Command Aligned
<b>SRG</b>	Senior Review Group
<b>SRM</b>	Sustainment, Restoration and Modernization

## HOW THE ARMY RUNS

<b>SRO</b>	System Readiness Objective
<b>SROC</b>	Senior Readiness Oversight Council
<b>SRP</b>	Soldier Readiness Processing
<b>SRP</b>	Sustainable Range Program
<b>SRT</b>	Strategic Readiness Tenet
<b>SRTRA</b>	Short-Range Training Resources Analysis
<b>SRU</b>	Strategic Readiness Update
<b>SRUF</b>	Standing Rules for the Use of Force
<b>SS</b>	Sustaining (Program Evaluation Group (PEG))
<b>SS</b>	Supportability Strategy
<b>SSA</b>	Source Selection Authority
<b>SSA</b>	Staff Support Agency
<b>SSA</b>	System Safety Assessment
<b>SSC</b>	Senior Service College
<b>SSD</b>	Structured Self-Development
<b>SSG</b>	Staff Sergeant
<b>SSMS</b>	Service Support Manpower System
<b>SSN</b>	Standard Study Number
<b>SSO</b>	Synchronization Staff Officer
<b>SSP</b>	Service Support Program
<b>ST</b>	Scientific and Technical
<b>ST</b>	Sustainment Training
<b>STANFINS</b>	Standard Financial System
<b>STAR</b>	System Threat Assessment Report
<b>START</b>	Scientific and Technical Advisory and Response Team
<b>STO</b>	Split Training Option
<b>STP</b>	Short Term Project
<b>STP</b>	Soldier Training Publication
<b>STRAMS-E</b>	Student / Trainee Management System-Enlisted
<b>STRAP</b>	System Training Plan
<b>STSP</b>	Soldier Training Support Program
<b>STTR</b>	Small Business Technology Transfer Pilot Program
<b>STX</b>	Situational Training Exercises
<b>SUE</b>	System Under Evaluation
<b>SUT</b>	System Under Testing
<b>SVP</b>	Special Visibility Program
<b>SWANCC</b>	Solid Waste Agency of Northern Cook County
<b>T&amp;E</b>	Test and Evaluation
<b>T&amp;EO</b>	Training and Evaluation Outline

<b>TAA</b>	Total Army Analysis
<b>TACITS</b>	Total Army Centralized Individual Training Solicitation
<b>TACOM</b>	U.S. Army Tank-Automotive and Armaments Command
<b>TADSS</b>	Training Aids, Devices, Simulations, and Simulators
<b>TAEDP</b>	The Army Equipment Distribution Program
<b>TAG</b>	The Adjutant General
<b>TAP</b>	The Army Plan
<b>TAPDB</b>	Total Army Personnel Database
<b>TAPDB-AE</b>	Total Army Personnel Database-Active Enlisted
<b>TAPDB-AO</b>	Total Army Personnel Database-Active Officer
<b>TAPDB-MOB</b>	Total Army Personnel Database-Mobilization
<b>TAPES</b>	Total Army Performance Evaluation System
<b>TASS</b>	The Army School System
<b>TATS</b>	Total Army Training System
<b>TAV</b>	Total Asset Visibility
<b>TBE</b>	Training Base Expansion
<b>TC</b>	Training Command
<b>TC</b>	Type Classification
<b>TCM</b>	U.S. Army Training and Doctrine Command (TRADOC) Capability Manager
<b>TD</b>	Technology Demonstration
<b>TD</b>	Training Development
<b>TDA</b>	Table of Distribution and Allowances
<b>TDDC</b>	Training and Doctrine Development Configuration
<b>TDDT</b>	Training and Doctrine Development Tool
<b>TDS</b>	Technology Development Strategy
<b>TDY</b>	Temporary Duty
<b>TE</b>	Training Environment
<b>TECD</b>	Technology-Enabled Capability Demonstration
<b>TEDP</b>	Training and Education Development Process
<b>TEM</b>	Training Execution Matrices
<b>TEMP</b>	Test and Evaluation Master Plan
<b>TESC</b>	Training Enterprise Scheduling Capability
<b>TEU</b>	Technical Escort Unit
<b>TF</b>	Task Force
<b>TFE</b>	Tactical Field Exchange
<b>TFER</b>	Task Force for Emergency Readiness
<b>TFM</b>	Training Feedback Module
<b>TFT</b>	Technical Field Test
<b>TG</b>	Training Guide

## HOW THE ARMY RUNS

<b>TGM</b>	Technical Guidance Memorandum
<b>TID</b>	Training Integration Directorate
<b>TIG</b>	The Inspector General
<b>TIG</b>	Time in Grade
<b>TII</b>	Training Information Infrastructure
<b>TIM</b>	Transformation of Installation Management
<b>TIS</b>	Time in Service
<b>TISO</b>	Threat Integration Staff Officer
<b>TJAG</b>	The Judge Advocate General
<b>TJAGLCS</b>	U.S. Army The Judge Advocate General Legal Center and School
<b>TJC</b>	The Joint Commission
<b>TLAMM</b>	Theater Lead Agent for Medical Materiel
<b>TMA</b>	Training Mission Area
<b>TMA</b>	TRICARE Management Activity
<b>TMCA</b>	Theater Movement Control Agency
<b>TMD</b>	Theater Missile Defense
<b>TMIP</b>	Theater Medical Information Program
<b>TMOPEs</b>	U.S. Training and Doctrine Command (TRADOC) Mobilization and Operation Planning and Execution System
<b>TNGDEV</b>	Training Developer
<b>TO</b>	Theater Opening
<b>TOA</b>	Total Obligation Authority
<b>TOE</b>	Table of Organization and Equipment
<b>TOMA</b>	Training Operations Management Activity
<b>TOPMIS</b>	Total Officer Personnel Management Information System
<b>TP</b>	Training Publication
<b>TPE</b>	Theater Provided Equipment
<b>TPF</b>	Total Package Fielding
<b>TPFDD</b>	Time-Phased Force and Deployment Data
<b>TPG</b>	Transformation Planning Guidance
<b>TPSN</b>	Troop Program Sequence Number
<b>TPU</b>	Troop Program Unit
<b>TRA</b>	Technology Readiness Assessment
<b>TRAC</b>	Training and Doctrine Command Analysis Center
<b>TRAC2ES</b>	Transportation Command (TRANSCOM) Regulating and Command and Control Evacuation System
<b>TRADOC</b>	U.S. Army Training and Doctrine Command
<b>TRAP</b>	Training Resources Arbitration Panel
<b>TRAS</b>	Training Requirements Analysis System
<b>TRL</b>	Technology Readiness Level

<b>TRM</b>	Training Resource Model
<b>TRMC</b>	Training Resource Management Capability
<b>TRP</b>	Test Resource Plan
<b>TSARC</b>	Test Schedule and Review Committee
<b>TSB</b>	Training Support Brigade
<b>TSC</b>	Theater Sustainment Command
<b>TSC</b>	Training Support Center
<b>TSG</b>	The Surgeon General
<b>TSP</b>	Training Support Package
<b>TSR</b>	Training Support Requirements
<b>TSS</b>	Training Support System
<b>TSWG</b>	Training Support Working Group
<b>TT</b>	Training (Program Evaluation Group (PEG))
<b>TTHS</b>	Trainees, Transients, Holdees, and Students
<b>TTP</b>	Tactics, Techniques, and Procedures
<b>TTRRS</b>	U.S. Training and Doctrine Command (TRADOC) The Army School System (TASS) Readiness Reporting System
<b>TVA</b>	Tennessee Valley Authority
<b>TWOS</b>	Total Warrant Officer System
<b>TYAD</b>	Tobyhanna Army Depot
<b>UAD</b>	Updated Authorizations Document
<b>UAS</b>	Unit Activation Schedule
<b>UAV</b>	Unmanned Aerial Vehicle
<b>UCMJ</b>	Uniform Code of Military Justice
<b>UCP</b>	Unified Command Plan
<b>UFR</b>	Unfunded Requirement
<b>UHTS</b>	Unsourced and/or Hard to Source
<b>UIC</b>	Unit Identification Code
<b>UICIO</b>	Unit Identification Code Information Officer
<b>UJTL</b>	Universal Joint Task List
<b>ULO</b>	Unified Land Operations
<b>ULOMETL</b>	Unified Land Operations Mission Essential Task List
<b>ULP</b>	Unfair Labor Practice
<b>UMD</b>	Unmatched Disbursements
<b>UMFP</b>	Unit Materiel Fielding Points
<b>UMMCA</b>	Unspecified Minor Military Construction Army
<b>UNAAF</b>	Unified Action Armed Forces
<b>UON</b>	Urgent Operational Need
<b>URS</b>	Unit Reference Sheet

## HOW THE ARMY RUNS

<b>U.S.</b>	United States
<b>USA</b>	Under Secretary of the Army
<b>USAAA</b>	U.S. Army Audit Agency
<b>USAAC</b>	U.S. Army Accessions Command
<b>USAASB</b>	U.S. Army Acquisition Support Brigade
<b>USAASC</b>	U.S. Army Acquisition Support Center
<b>USACC</b>	U.S. Army Cadet Command
<b>USACCSA</b>	U.S. Army Command and Control Support Agency
<b>USACE</b>	U.S. Army Corps of Engineers
<b>USACIDC</b>	U.S. Army Criminal Investigation Command
<b>USAFMCOM</b>	U.S. Army Financial Management Command
<b>USAFMSA</b>	U.S. Army Force Management Support Agency
<b>USAFRICOM</b>	U.S. Africa Command
<b>USAIGA</b>	U.S. Army Inspector General Agency
<b>USAJFKSWCS</b>	U.S. Army John F. Kennedy Special Warfare Center and School
<b>USALSA</b>	U.S. Army Legal Services Agency
<b>USAMAA</b>	U.S. Army Manpower Analysis Agency
<b>USAMRICD</b>	U.S. Army Medical Research Institute of Chemical Defense
<b>USAMRIID</b>	U.S. Army Medical Research Institute of Infectious Diseases
<b>USAMRMC</b>	U.S. Army Medical Research and Materiel Command
<b>USANCA</b>	U.S. Army Nuclear and Combating Weapons of Mass Destruction (WMD) Agency
<b>USAPA</b>	U.S. Army Publishing Agency
<b>USAPHC</b>	U.S. Army Public Health Command
<b>USAR</b>	U.S. Army Reserve
<b>USARAF / SETAF</b>	U.S. Army Africa / Southern European Task Force
<b>USARC</b>	U.S. Army Reserve Command
<b>USARCENT</b>	U.S. Army, Central
<b>USAREC</b>	U.S. Army Recruiting Command
<b>USAREUR</b>	U.S. Army, Europe
<b>USARF</b>	U.S. Army Reserve Forces
<b>USARNORTH</b>	U. S. Army, North
<b>USARPAC</b>	U.S. Army, Pacific
<b>USARSO</b>	U.S. Army, South
<b>USASAC</b>	U.S. Army Security Assistance Command
<b>USASATMO</b>	U.S. Army Security Assistance Training Management Organization
<b>USASMDC / ARSTRAT</b>	U.S. Army Space and Missile Defense Command / Army Strategic Command
<b>USASOC</b>	U.S. Army Special Operations Command
<b>USASSI</b>	U.S. Army Soldier Support Institute
<b>USATC</b>	U.S. Army Training Center



<b>USAWC</b>	U.S. Army War College
<b>USC</b>	U.S. Code
<b>USCENTCOM</b>	U.S. Central Command
<b>USCG</b>	U.S. Coast Guard
<b>USD</b>	Under Secretary of Defense
<b>USDA</b>	U.S. Department of Agriculture
<b>USD(P)</b>	Under Secretary of Defense (Policy)
<b>USD(AT&amp;L)</b>	Under Secretary of Defense (Acquisition, Technology, and Logistics)
<b>USD(C)</b>	Under Secretary of Defense (Comptroller)
<b>USD(P&amp;R)</b>	Under Secretary of Defense (Personnel and Readiness)
<b>USERRA</b>	Uniform Services Employment and Reemployment Rights Act
<b>USF</b>	Unit Set Fielding
<b>USFOR-A</b>	U.S. Forces-Afghanistan
<b>USFOR-I</b>	U.S. Forces-Iraq
<b>USPFO</b>	U.S. Property & Fiscal Office
<b>USG</b>	U.S. Government
<b>USMA</b>	U.S. Military Academy
<b>USMEDCOM</b>	Medical Command
<b>USNORTHCOM</b>	U.S. Northern Command
<b>USPS</b>	U.S. Postal Service
<b>USPACOM</b>	U.S. Pacific Command
<b>USPFO</b>	U.S. Property and Fiscal Officer
<b>US&amp;R</b>	Urban Search and Rescue
<b>USR</b>	Unit Status Reporting
<b>USSOCOM</b>	U.S. Special Operations Command
<b>USSOUTHCOM</b>	U.S. Southern Command
<b>USSTRATCOM</b>	U.S. Strategic Command
<b>USTRANSCOM</b>	U.S. Transportation Command
<b>UTA</b>	Unit Training Assembly
<b>VC</b>	Veterinary Corps
<b>VCCT</b>	Virtual Combat Convoy Trainer
<b>VCJCS</b>	Vice Chairman of the Joint Chiefs of Staff
<b>VCSA</b>	Vice Chief of Staff, U.S. Army
<b>VEOA</b>	Veterans Employment Opportunity Act
<b>VERRP</b>	Voluntary Early Release and Retirement Program
<b>VI / TSC</b>	Visual Information / Training Support Centers
<b>VISMOD</b>	Visually Modified
<b>VMAT</b>	Veterinarian Medical Assistance Team
<b>VTC</b>	Video Teleconference

## HOW THE ARMY RUNS

<b>VTF</b>	Virtual Training Facility
<b>VTT</b>	Video Tele-Training
<b>WAS</b>	Wide Area Security
<b>WfF</b>	Warfighting Function
<b>WG</b>	Working Group
<b>WHINSEC</b>	Western Hemisphere Institute for Security Cooperation
<b>WHS</b>	Washington Headquarters Service
<b>WIN-T</b>	Warfighter Information Network-Tactical
<b>WIP</b>	Work In Process
<b>WIPT</b>	Working-Level Integrated Product Team
<b>WIT</b>	Weapons Intelligence Team
<b>WLC</b>	Warrior Leader Course
<b>WMD</b>	Weapons of Mass Destruction
<b>WMD-E</b>	Weapons of Mass Destruction-Elimination
<b>WMP</b>	Air Force War and Mobilization Plan
<b>WO</b>	Warrant Officer
<b>WOAC</b>	Warrant Officer Advanced Course
<b>WOBC</b>	Warrant Officer Basic Course
<b>WOCC</b>	Warrant Officer Career Center
<b>WOCS</b>	Warrant Officer Candidate School
<b>WOES</b>	Warrant Officer Education System
<b>WOILE</b>	Warrant Officer Intermediate Level Education
<b>WOLDAP</b>	Warrant Officer Leader Development Action Plan
<b>WOMA</b>	Warrant Officer Management Act
<b>WOS</b>	Warrant Officer Service
<b>WOSC</b>	Warrant Officer Staff Course
<b>WOSSC</b>	Warrant Officer Senior Staff Course
<b>WOSSE</b>	Warrant Officer Senior Service Education
<b>WPB</b>	War Production Board
<b>WRDA</b>	Water Resources Development Act
<b>WRMR</b>	War Reserve Materiel Requirement
<b>WRMS</b>	War Reserve Materiel Stock
<b>WTC</b>	Warrior Transition Command
<b>WTCV</b>	Weapons and Tracked Combat Vehicles
<b>WVA</b>	Watervliet Arsenal
<b>WWW</b>	World-Wide Web
<b>XCTC</b>	Exportable Combat Training Capability
<b>Y / Q / N</b>	Yes / Qualified Yes / No
<b>ZLIN</b>	Developmental Line Item Number

**This page is intentionally left blank**

**This page is intentionally left blank**

# ARMY FORCE MANAGEMENT MODEL

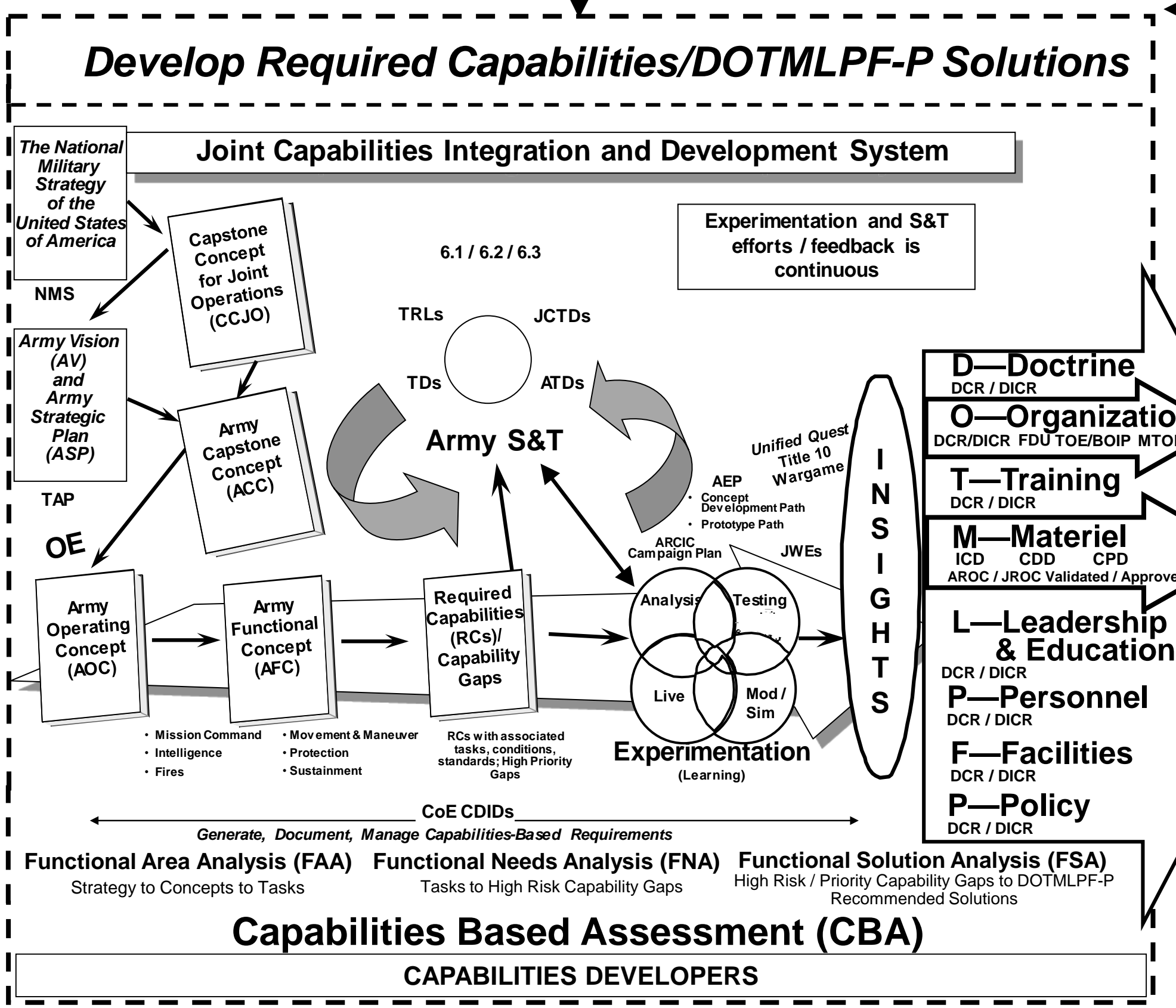
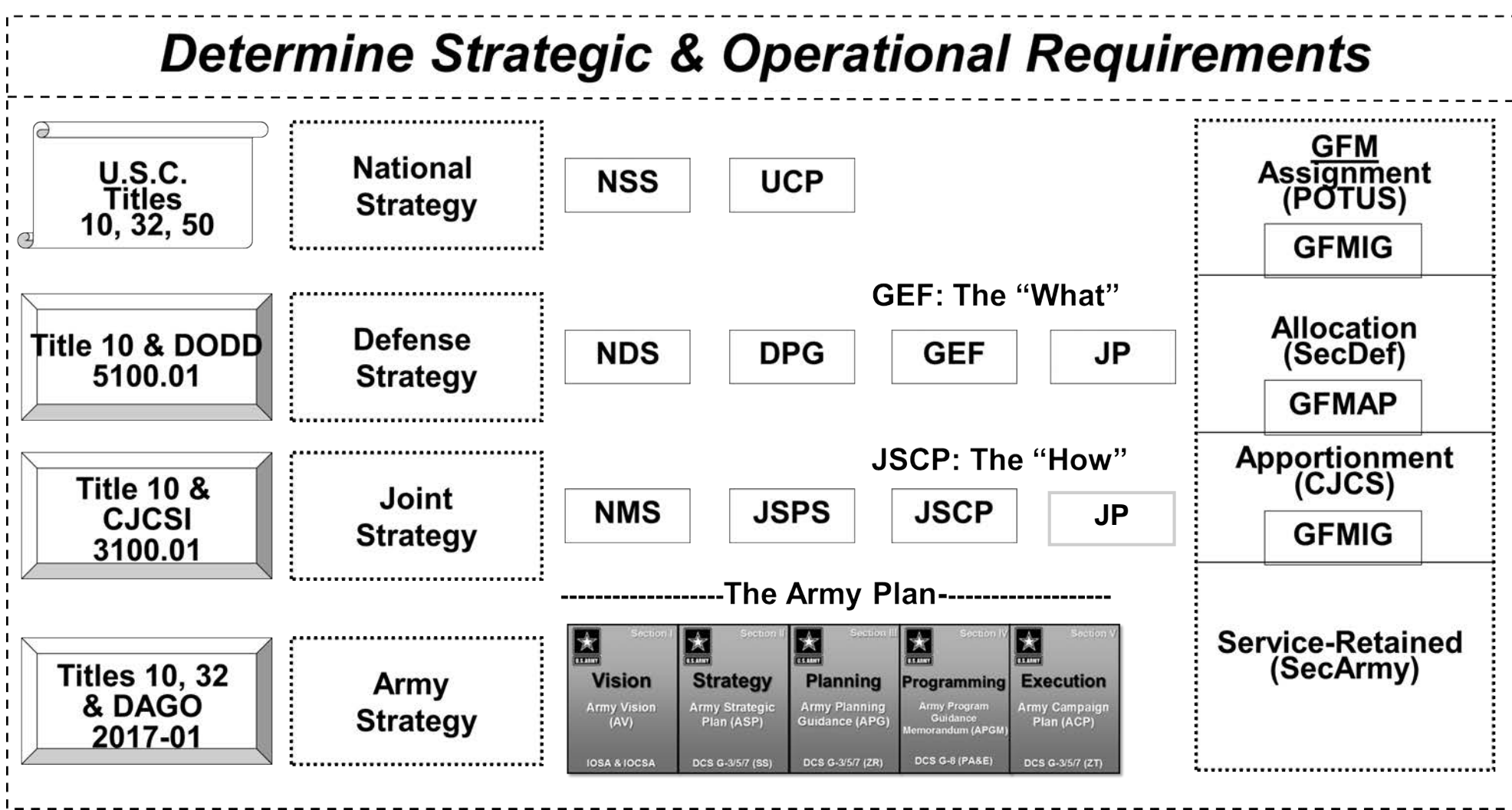

- AAAMP**: Active Army Military Manpower Program  
**AAO**: Army Acquisition Objective  
**ACSIM**: Assistant Chief of Staff Installation Management  
**ACP**: Army Campaign Plan  
**ADM**: Acquisition Decision Memorandum  
**ADP**: Army Planning Document  
**AE**: Army Experimentation Plan  
**AE2S**: Army Equipping Enterprise System  
**AMS**: Army Mobilization System  
**AOIAE**: Active Officer / Active Enlisted  
**APAS**: Army Personnel Assignment System  
**APG**: Army Program Guidance  
**ARADS**: Army Recruiting and Accession Data System  
**ARCIC**: Army Capabilities Integration Center  
**ARNG**: Army National Guard  
**AROC**: Army Requirements Oversight Council  
**ARPRINT**: Army Program for Individual Training  
**ARSTAF**: Army Staff  
**AS**: Acquisition Strategy  
**ASP**: Army Strategic Plan  
**ASTMP**: Army Science & Technology Master Plan  
**ATC**: Army Training Center  
**ATD**: Advanced Technology Demonstration
- ATRS**: Army Training Requirements and Resources System  
**AUTS**: Automated Update Transaction System  
**AV**: Army Vision  
**AWE**: Advanced Warfighter Experiment  
**BOIP**: Basis-of-Issue Plan  
**BOIPFD**: BOIP Feeder Data  
**CAD**: Course Administrative Data  
**CAP DEV**: Capability Developer  
**CBA**: Capability Based Assessment  
**CBD**: Capability Development Document  
**CDD**: Capability Development Document  
**CDI**: Capability Development Integration Directorate  
**CDR**: Critical Design Review  
**CONPLAN**: Concept Plan  
**CJA**: Comprehensive Joint Assessment  
**CJCSI**: Chairman of the Joint Chiefs Instruction  
**COE**: Center of Excellence  
**COTS**: Commercial Off The Shelf  
**CPA**: Chairman's Program Assessment  
**CPD**: Capability Production Document  
**CPR**: Chairman's Program Recommendation  
**CSA**: Chairman's Assessment  
**DAGO**: Department of the Army General Order  
**DARPL**: Dynamic Army Resourcing Priority List
- DAS**: Defense Acquisition System  
**DCR**: Doctrine, Organization, Training, Materiel, Leadership & Education, Personnel, Facilities, and Policy Change Recommendation  
**DICR**: Doctrine, Organization, Training, Materiel, Leadership & Education, Personnel, Facilities, and Policy Integrated Change Recommendation  
**DI**: Document Integrator  
**DOC DEV**: Document Developer  
**DDI**: Department of Defense Directive  
**DODI**: Department of Defense Instruction  
**DOPMA**: Defense Officer Personnel Management Act  
**DOTMLPF-P**: Doctrine, Organization, Training, Materiel, Leadership & Education, Personnel, Facilities, and Policy  
**DSI**: Human Systems Integration  
**IA**: Individual Account  
**ICD**: Initial Capabilities Document  
**ILS**: Integrated Logistics Support  
**IOC**: Initial Operational Capability  
**IOTE**: Initial Operational Test and Evaluation  
**ITAEDP**: Integrated Total Army Equipment Distribution Program  
**ITP**: Individual Training Plan  
**JCSIM**: Joint Capabilities Integration and Development System  
**JCTD**: Joint Capabilities Technology Demonstration  
**JOE**: Joint Operating Environment

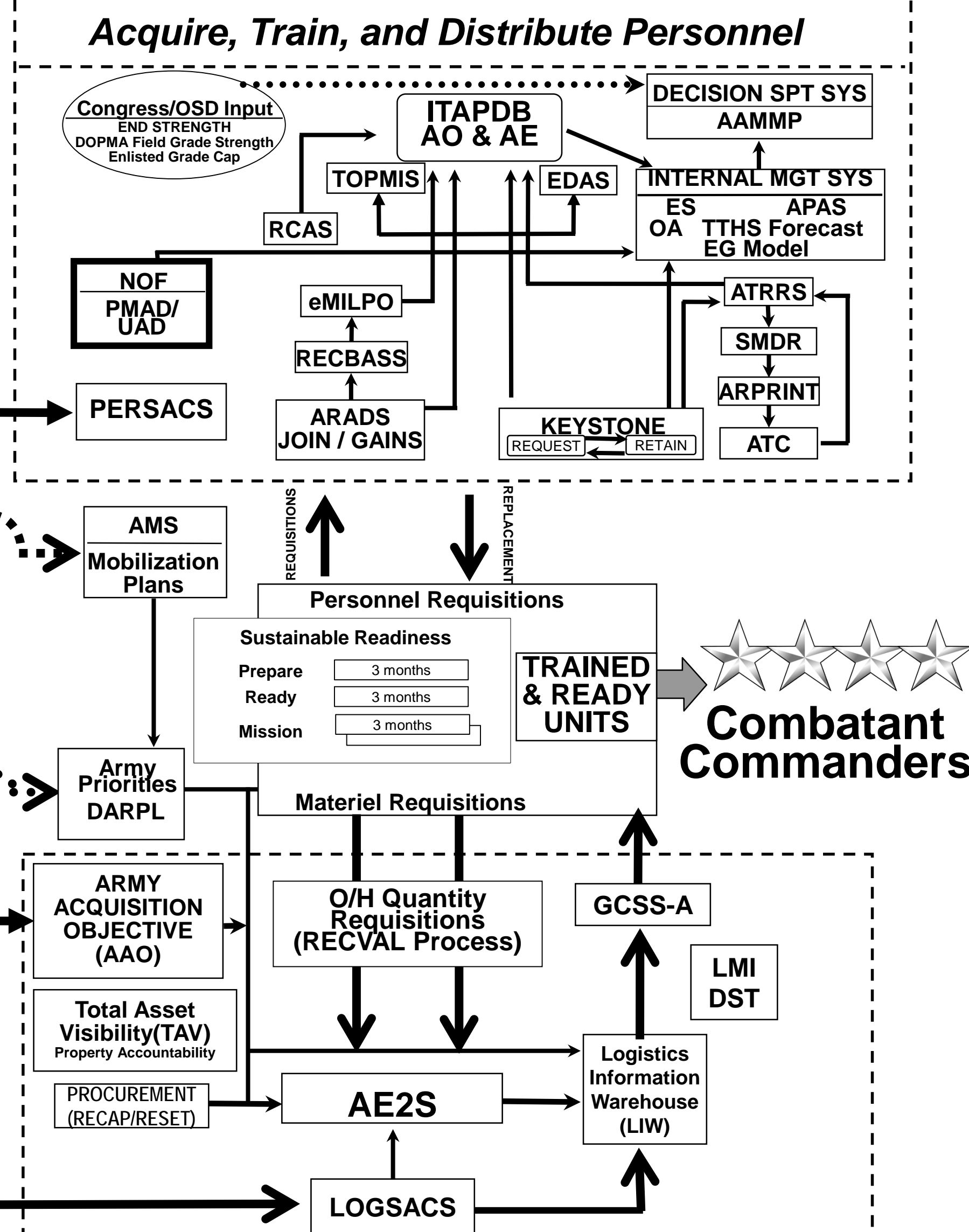
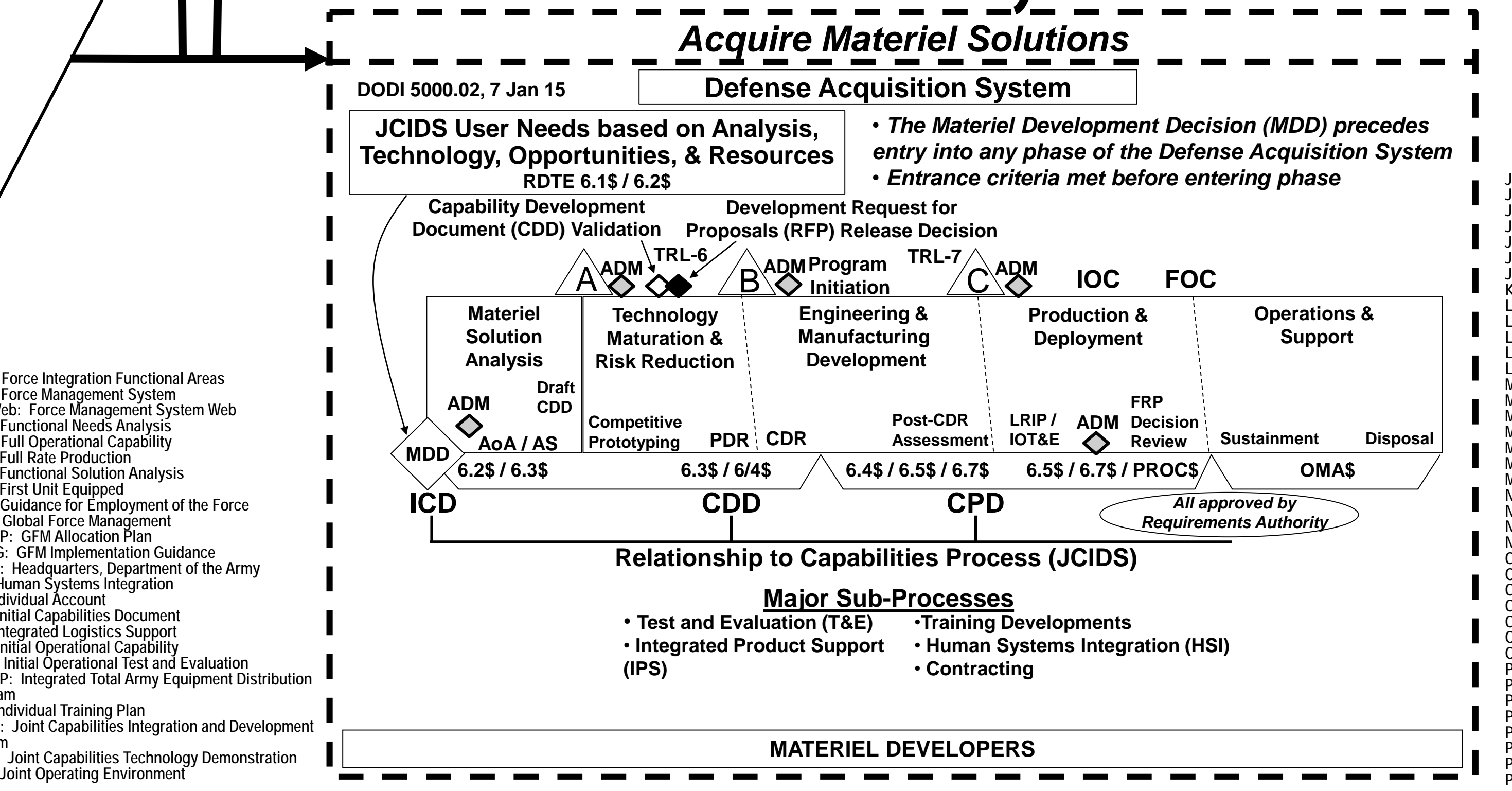
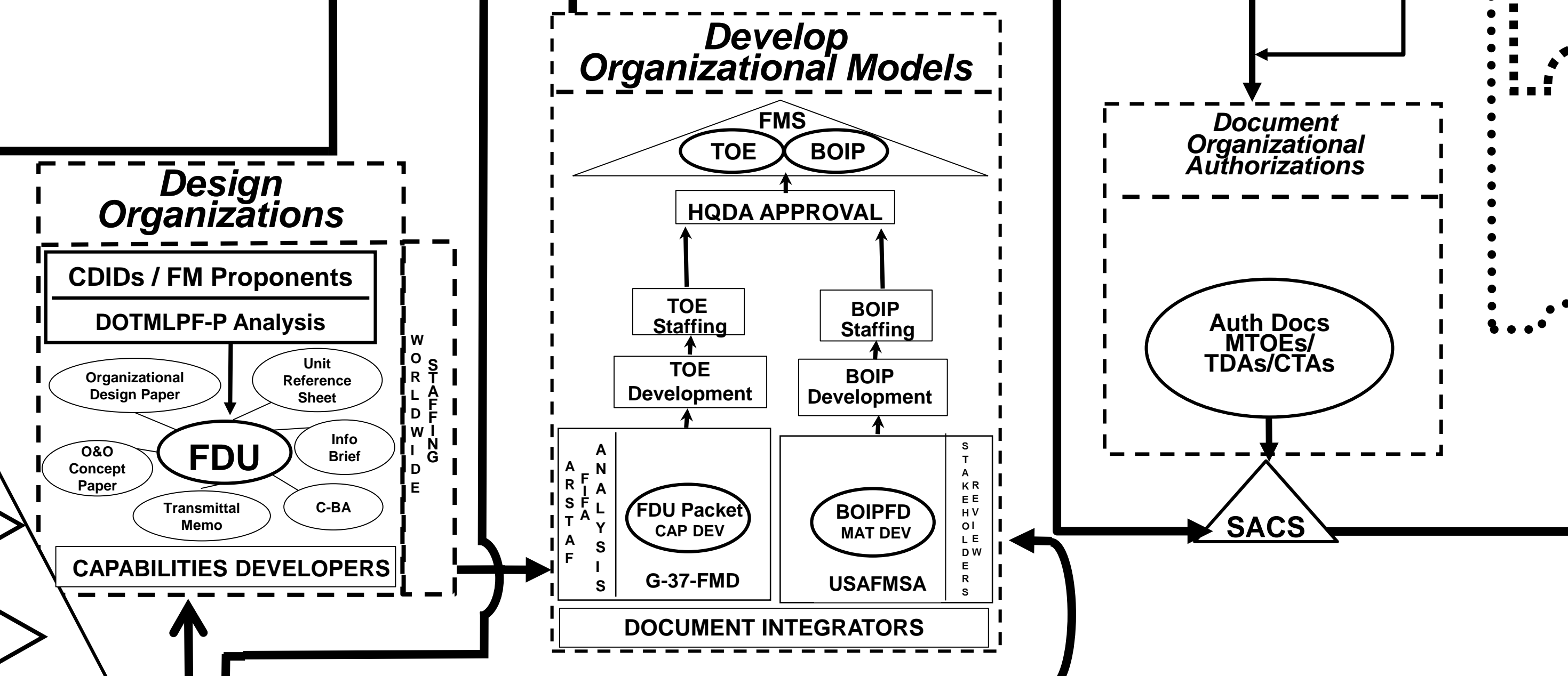
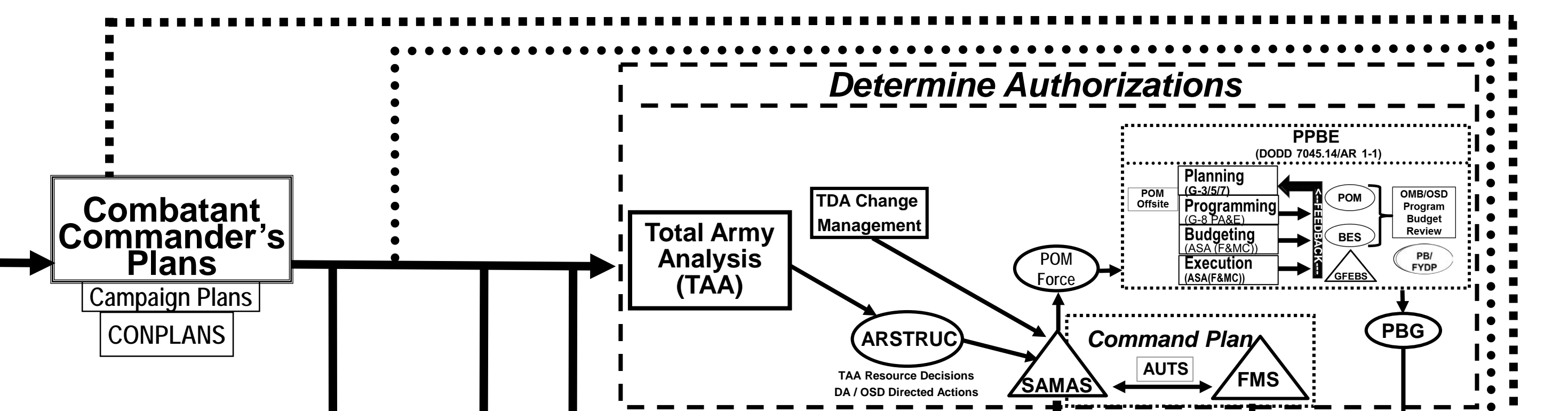

- JOIN**: Joint Optical Information System  
**JP**: Joint Planning  
**JROC**: Joint Requirements Oversight Council  
**JSCP**: Joint Strategic Capabilities Plan  
**JSPS**: Joint Strategic Planning System  
**JSR**: Joint Strategy Review  
**JWE**: Joint Warfighting Experiment  
**KEYSTONE**: Capstone Recruit & Retention System\*  
**LFT&E**: Live Fire Test and Evaluation  
**LIW**: Logistics Information Warehouse  
**LMI**: Lead Materiel Integrator  
**LOGSACS**: Logistics Structure and Composition System  
**LRIP**: Low Rate Initial Production  
**MAT DEV**: Materiel Developer  
**MDD**: Materiel Development Decision  
**MILCON**: Military Construction  
**MOD**: Modernization/Modernize  
**MS**: Milestone  
**MSA**: Materiel Solution Analysis  
**LOGSACS**: Logistics Structure and Composition System  
**MTOE**: Modified Table of Organization and Equipment  
**NDS**: National Defense Strategy  
**NMS**: National Military Strategy  
**NOF**: Nonlethal Force  
**NSS**: National Security Strategy  
**OA**: Officer Aggregate  
**O/H**: On Hand  
**OMAS**: Operations and Maintenance Appropriations  
**OPLAN**: Operation Plan  
**ORDAB**: Organizational Requirements Document Approval Briefing  
**OSD**: Office of the Secretary of Defense  
**PBG**: Program and Budget Guidance  
**PERSACS**: Personnel Structure and Composition System  
**PMAD**: Personnel Management Authorization Document  
**POI**: Program of Instruction  
**POM**: Program Objective Memorandum  
**POTUS**: President of the United States  
**PM**: Program Manager  
**PPBE**: Planning, Programming, Budgeting and Execution Process
- PROCS**: Procurement Dollars  
**PDR**: Preliminary Design Review  
**RDA**: Research, Development, and Acquisition  
**RDTE**: Research Development Test and Evaluation  
**RECBASS**: Reception Battalion Automated Support System  
**RMD**: Resource Management Decision  
**S & T**: Science & Technology  
**SACS**: Structure and Composition System  
**SAMAS**: Structure and Manpower Allocation System  
**SDOB**: Secretary of Defense Orders Book  
**SMDR**: Structure and Manning Decision Review  
**SRCA**: Service-Retained, Combatant Command-Aligned  
**SSO**: Synchronization Staff Officer  
**SRM**: Sustainable Readiness Model  
**T & E**: Test & Evaluation  
**TAA**: Total Army Analysis  
**TADS**: Training aids, devices, simulations, and simulators  
**TAPDB**: Total Army Personnel Database  
**TAPDB-AE**: Total Army Personnel Data Base-Active Enlisted  
**TAPDB-AO**: Total Army Personnel Data Base-Active Officer  
**TAV**: Total Asset Visibility  
**TD**: Technology Demonstration  
**TD**: Training Development  
**TDA**: Table of Distribution and Allowances  
**TNG DEV**: Training Developer  
**TOE**: Table of Organization and Equipment  
**TOPMIS**: Total Officer Personnel Management Information System  
**TPG**: Transformation Planning Guidance  
**TRADOC**: US Army Training and Doctrine Command  
**TRL**: Technology Readiness Level  
**TTHS**: Trainees, Transients, Holdees, Students  
**UAD**: Updated Authorization Document  
**UCP**: Unified Command Plan  
**URS**: Unit Reference Sheet  
**USAFMSA**: United States Army Force Management Support Agency  
**USAR**: United States Army Reserve  
**U.S.C.**: United States Code





